



Beginning Consonant: Vv

Directions: These pictures begin with the letter **Vv**. Color these pictures.



valentine

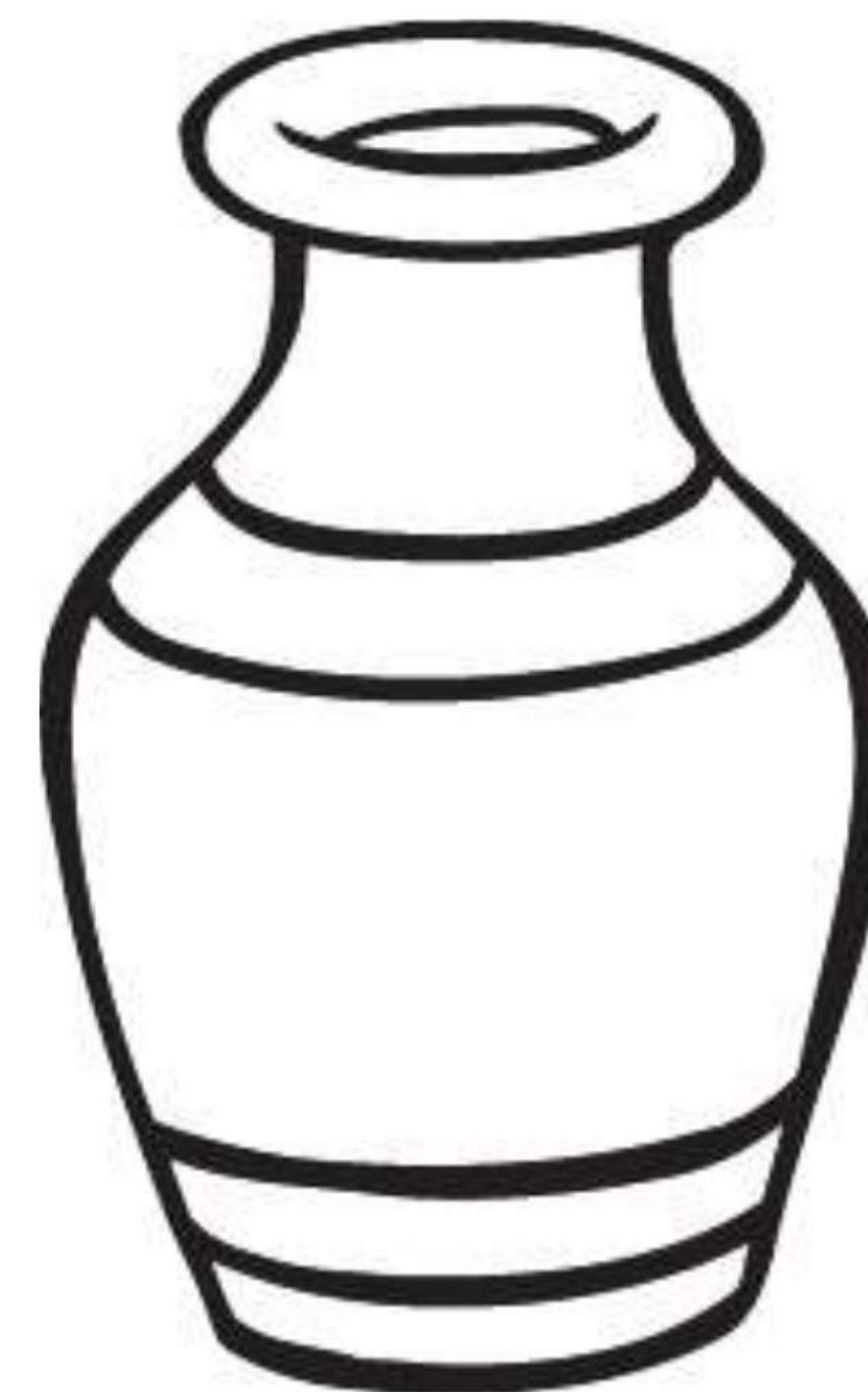

vase



vacuum



violin



Beginning Consonant: Ww

Directions: These pictures begin with the letter **Ww**. Color these pictures.

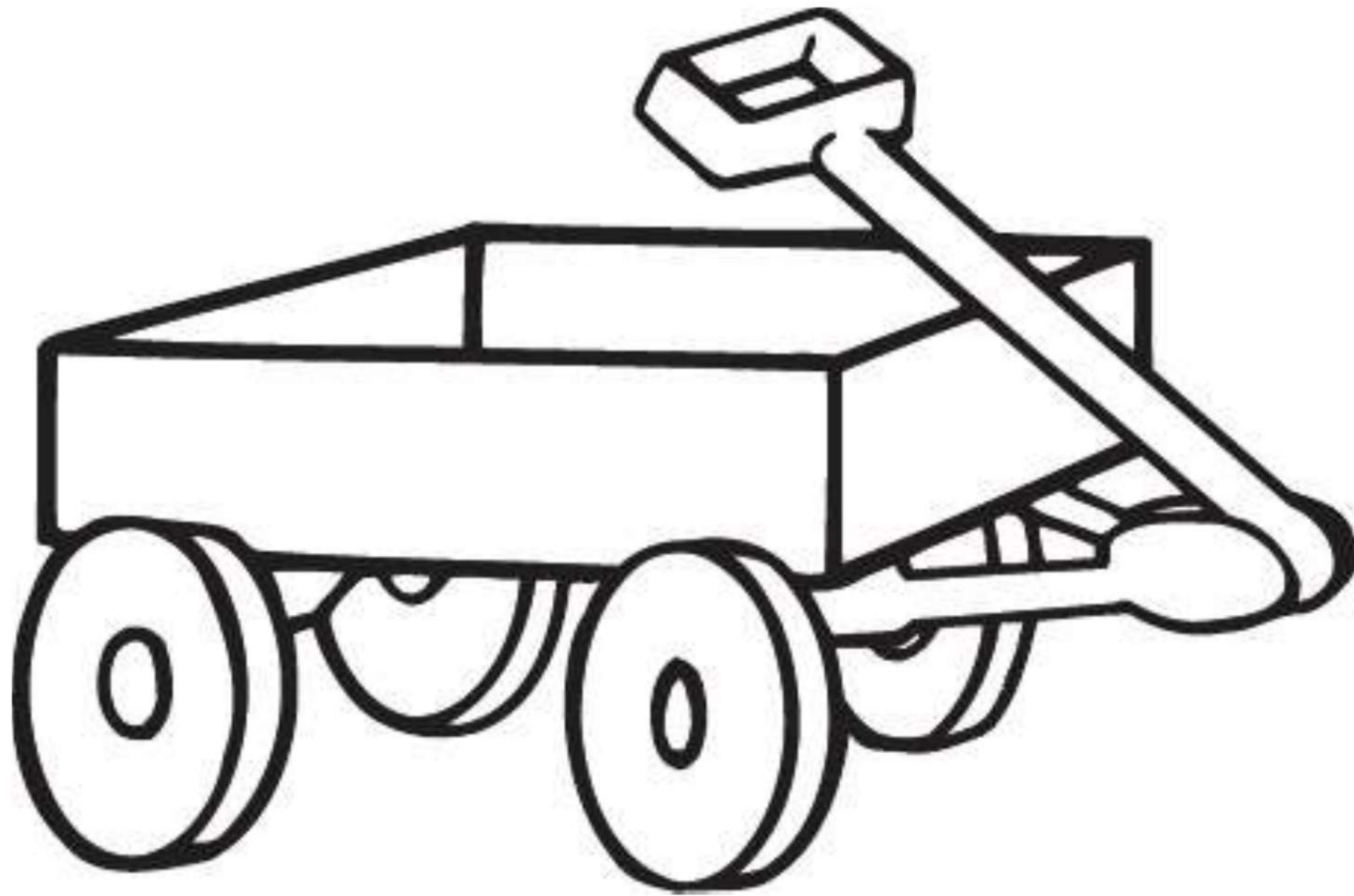

wagon



watch

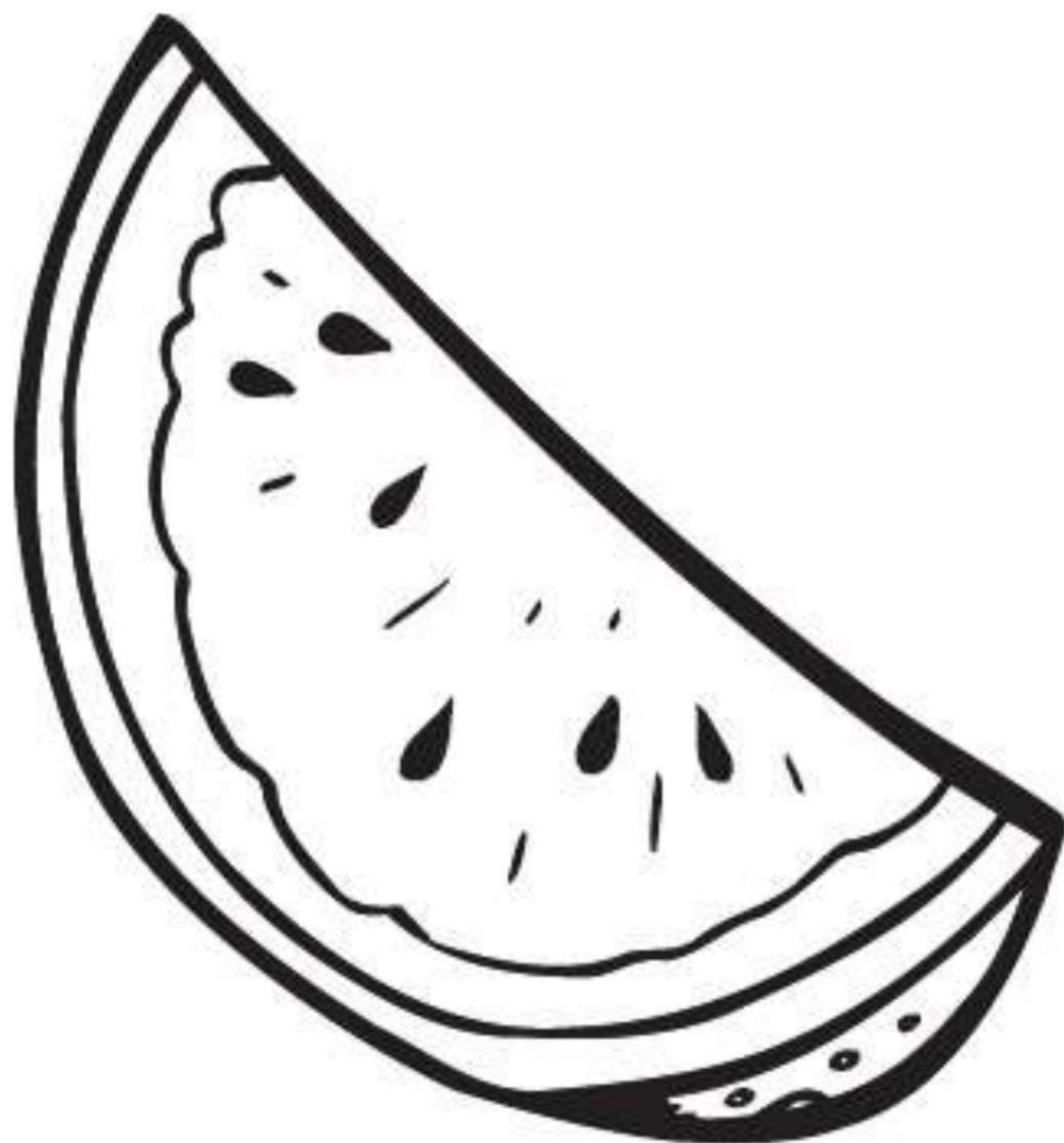

watermelon



window



Beginning Consonants: Tt, Vv, Ww

Directions: Say the sound the letters make. Circle the pictures in each row that begin with the letter shown.

Tt

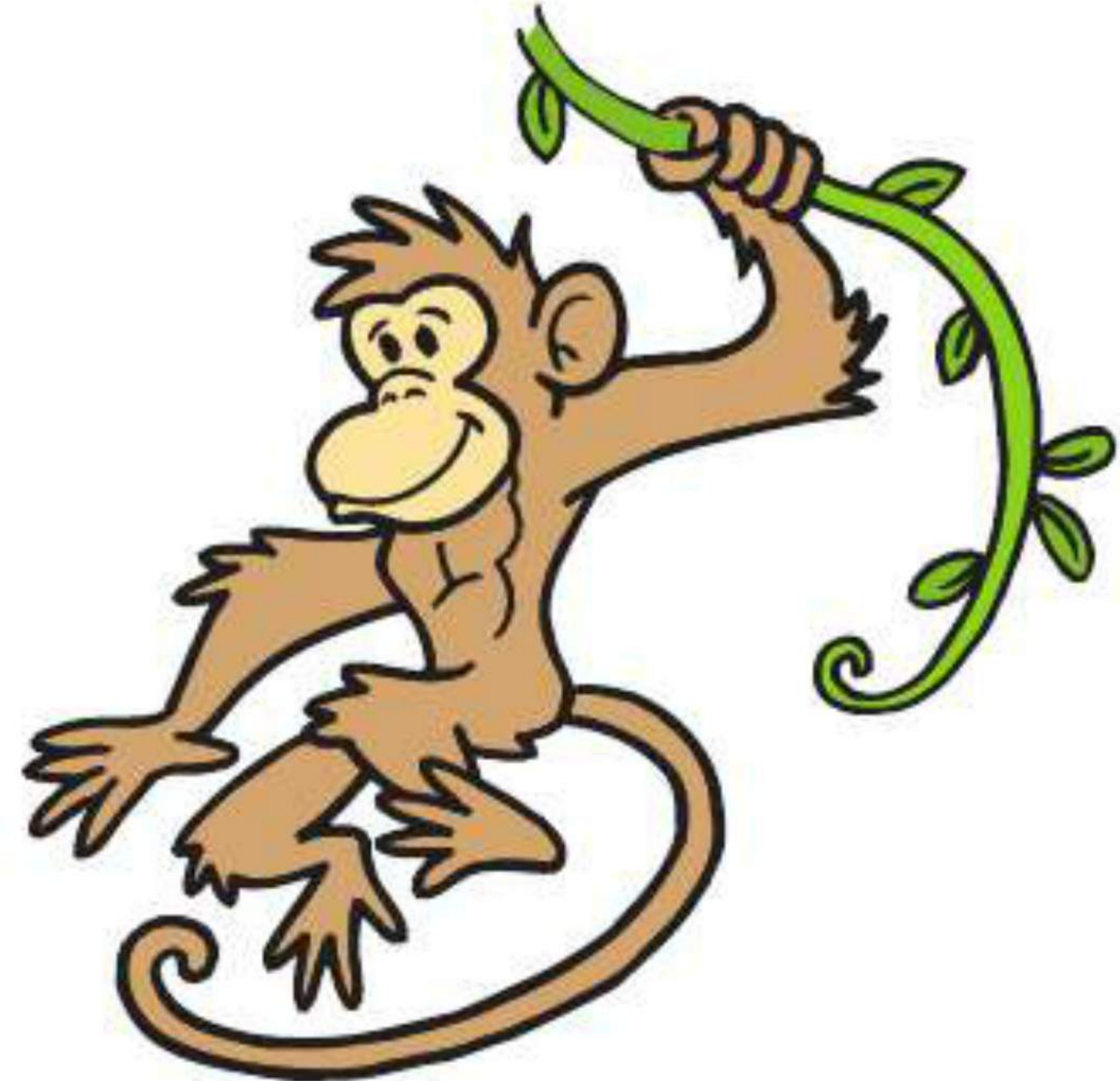

Vv

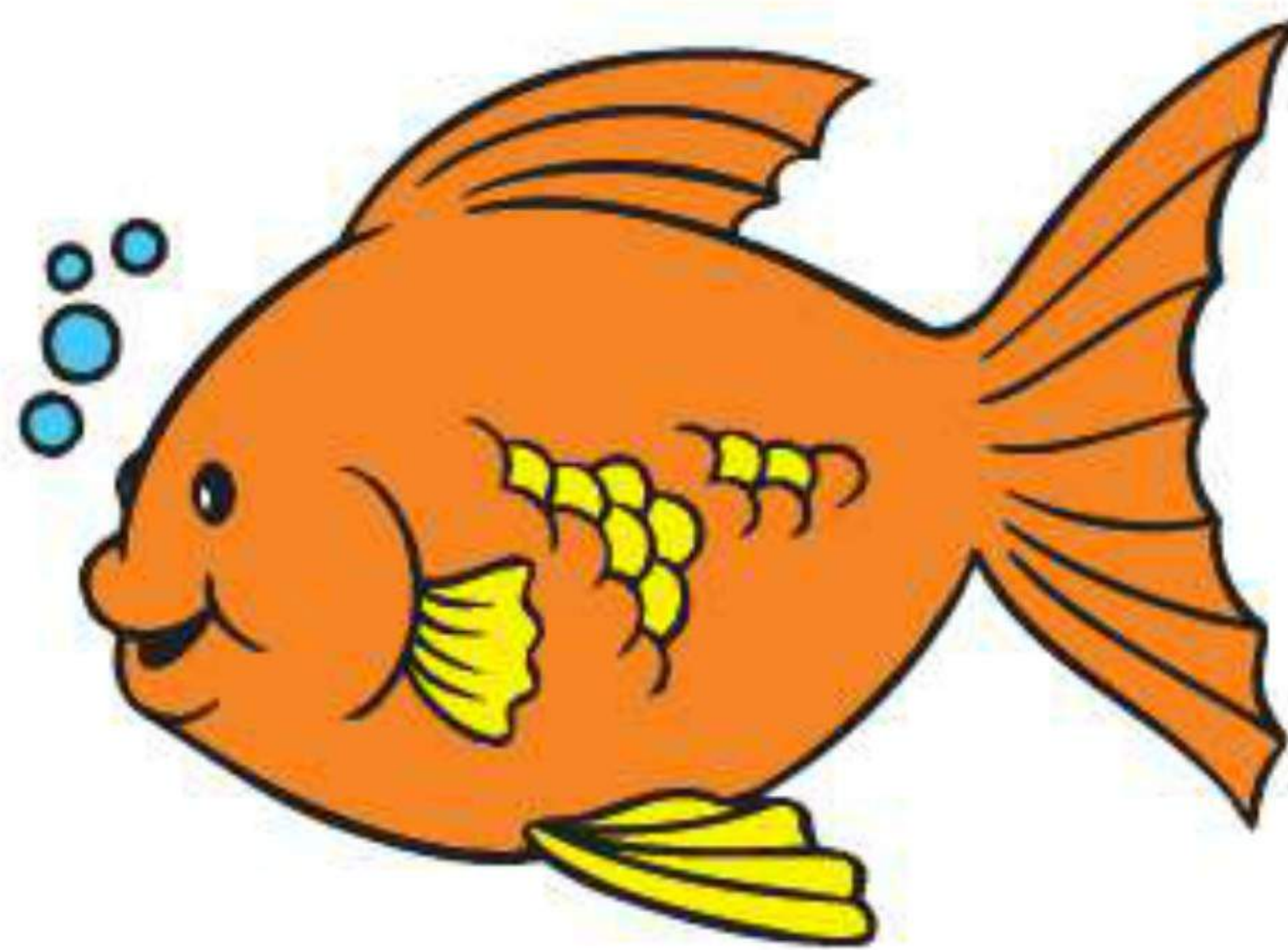

Ww





Consonant: Xx

Directions: These pictures have the letter **Xx** in them. Color these pictures.

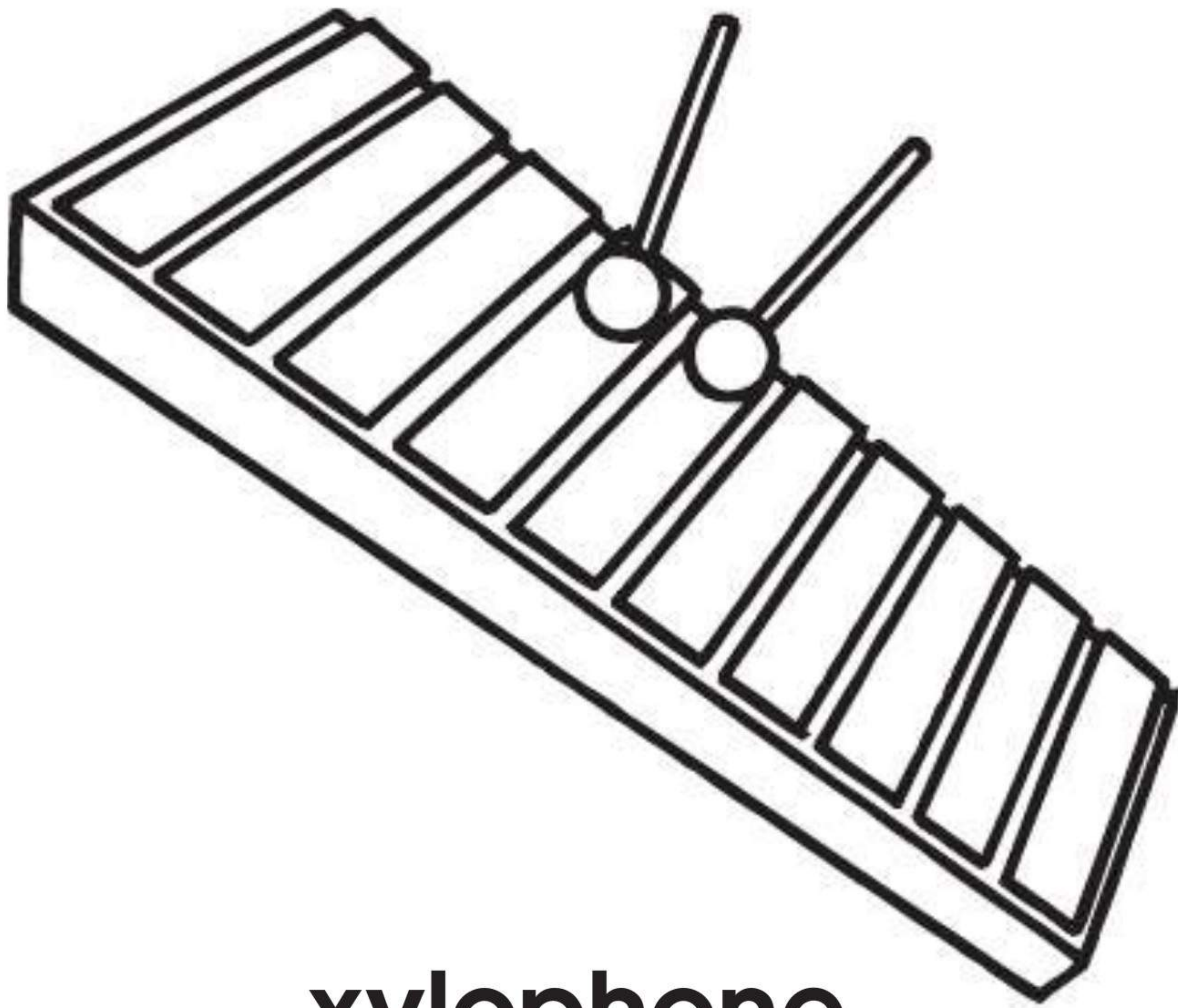

xylophone

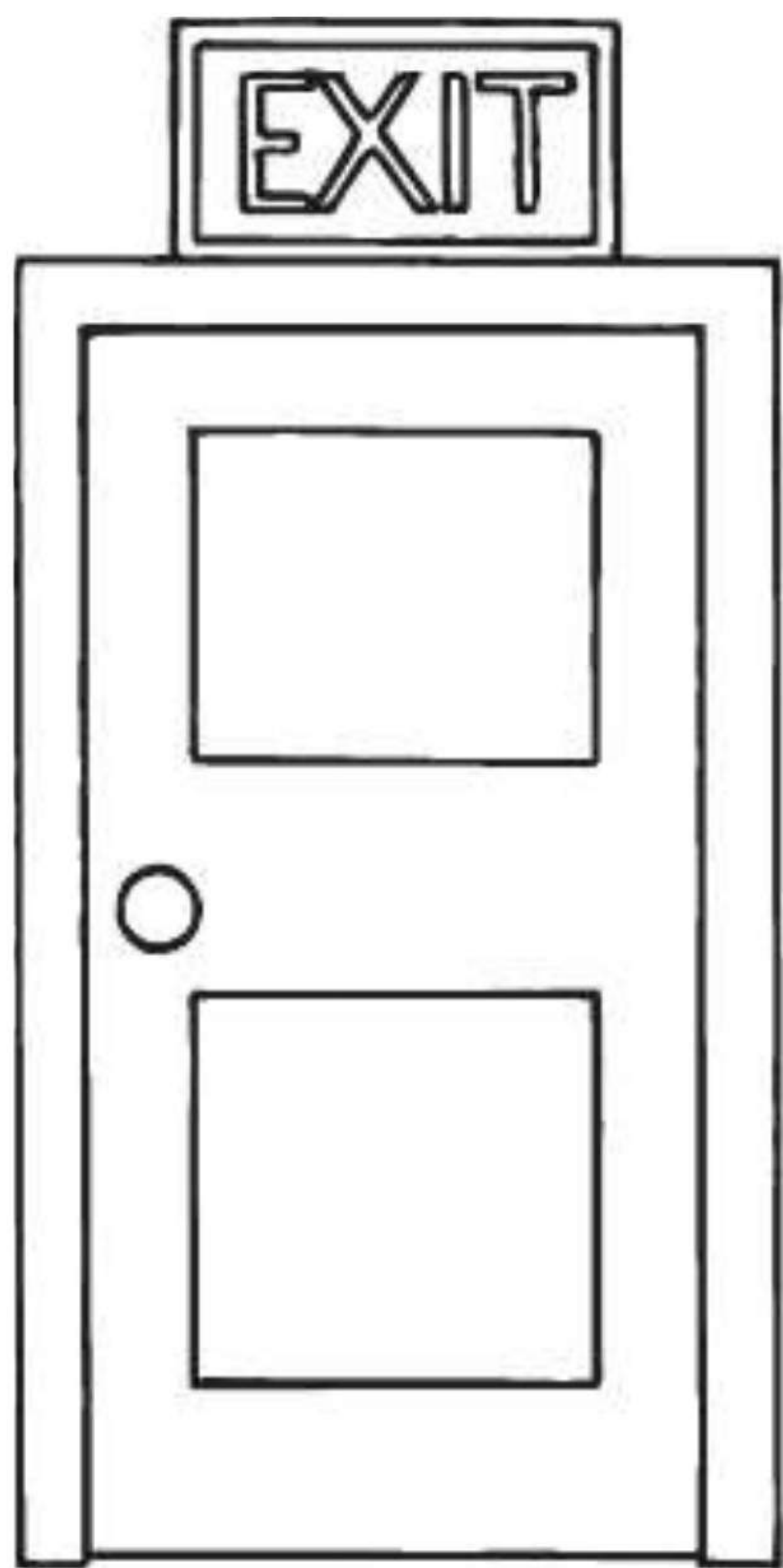

exit

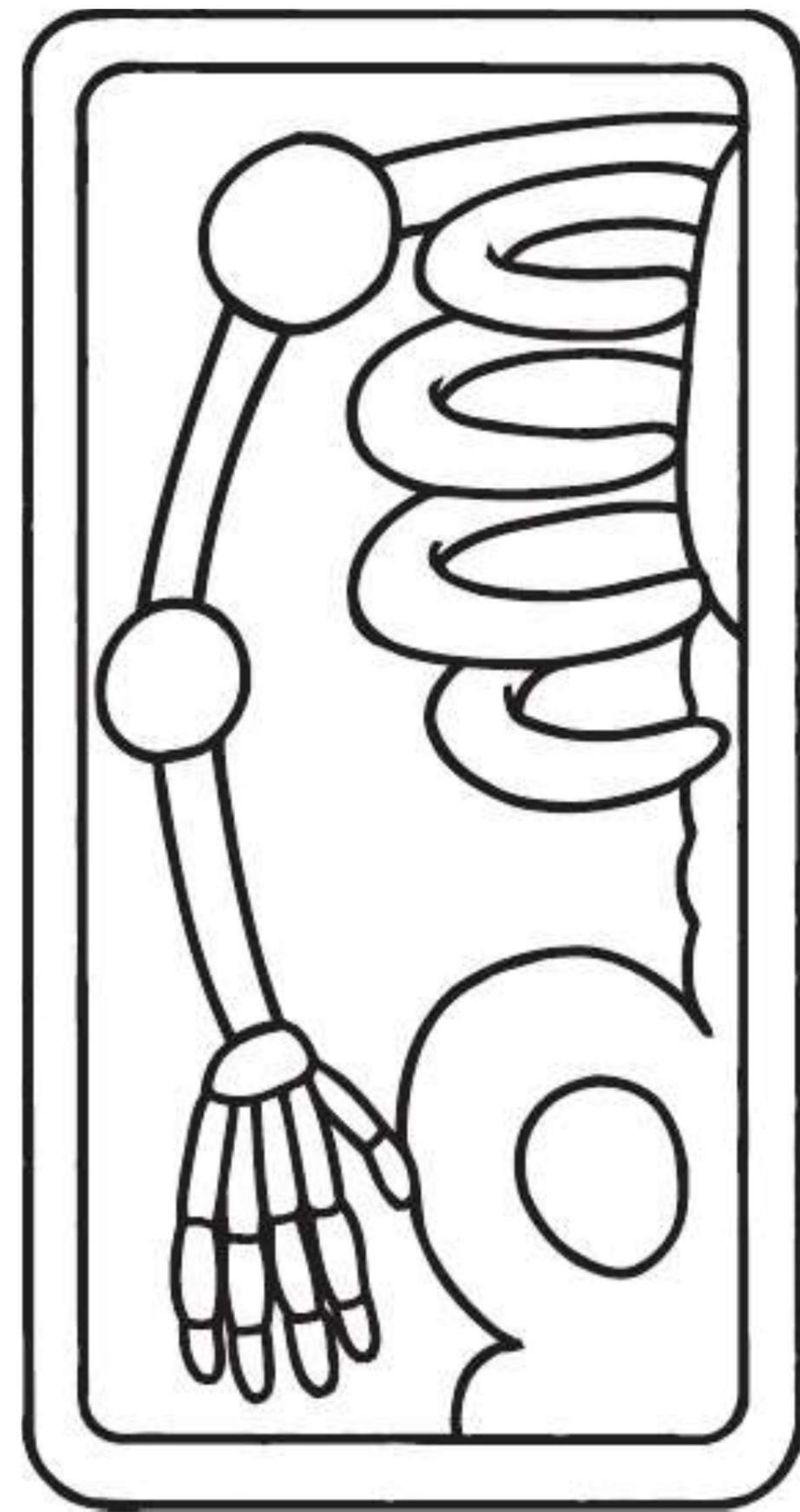

X-ray



Beginning Consonant: Yy

Directions: These pictures begin with the letter **Yy**. Color these pictures.

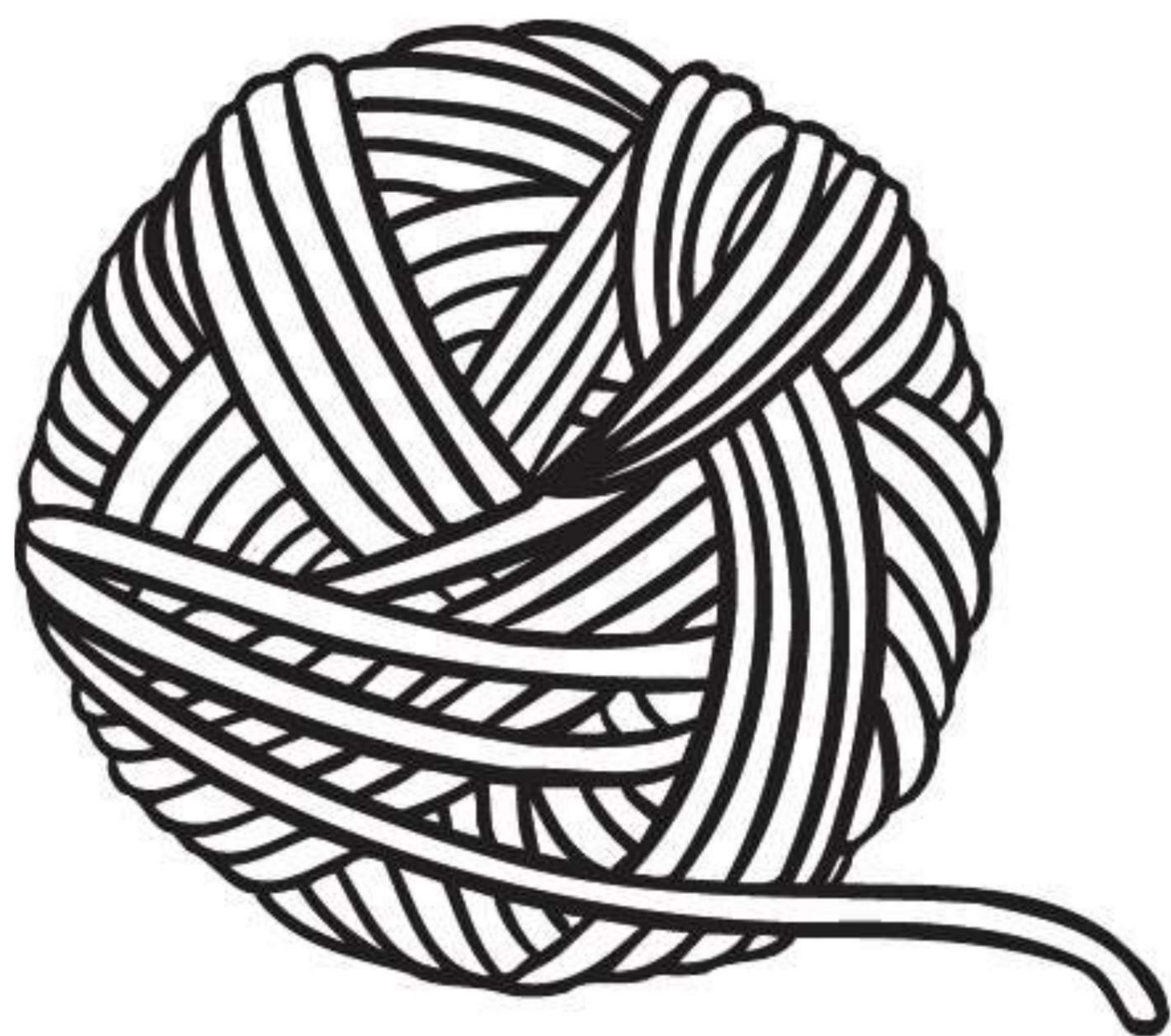

yarn

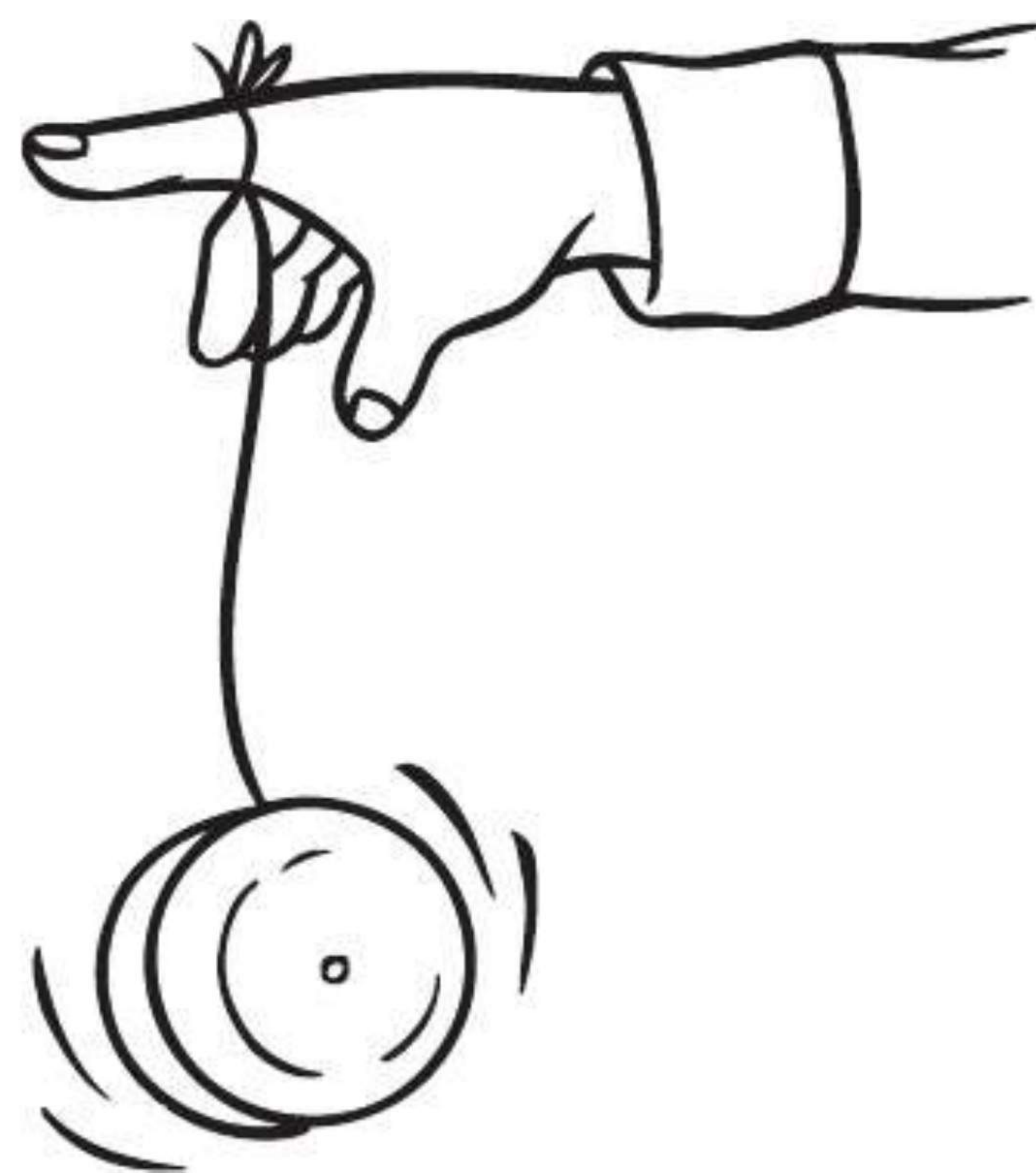

yo-yo

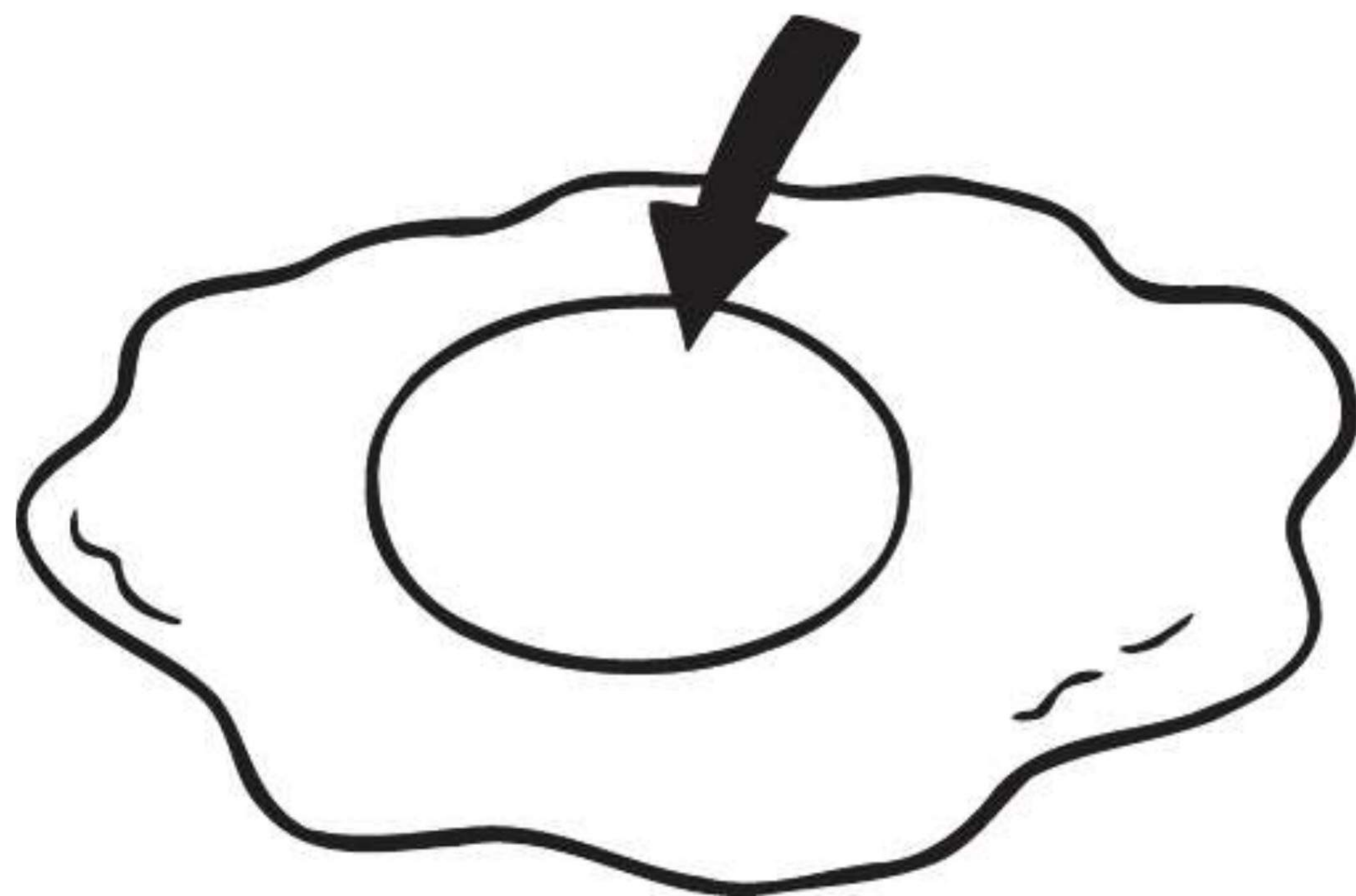

yolk



yak



Beginning Consonant: Zz

Directions: These pictures begin with the letter **Zz**. Color these pictures.

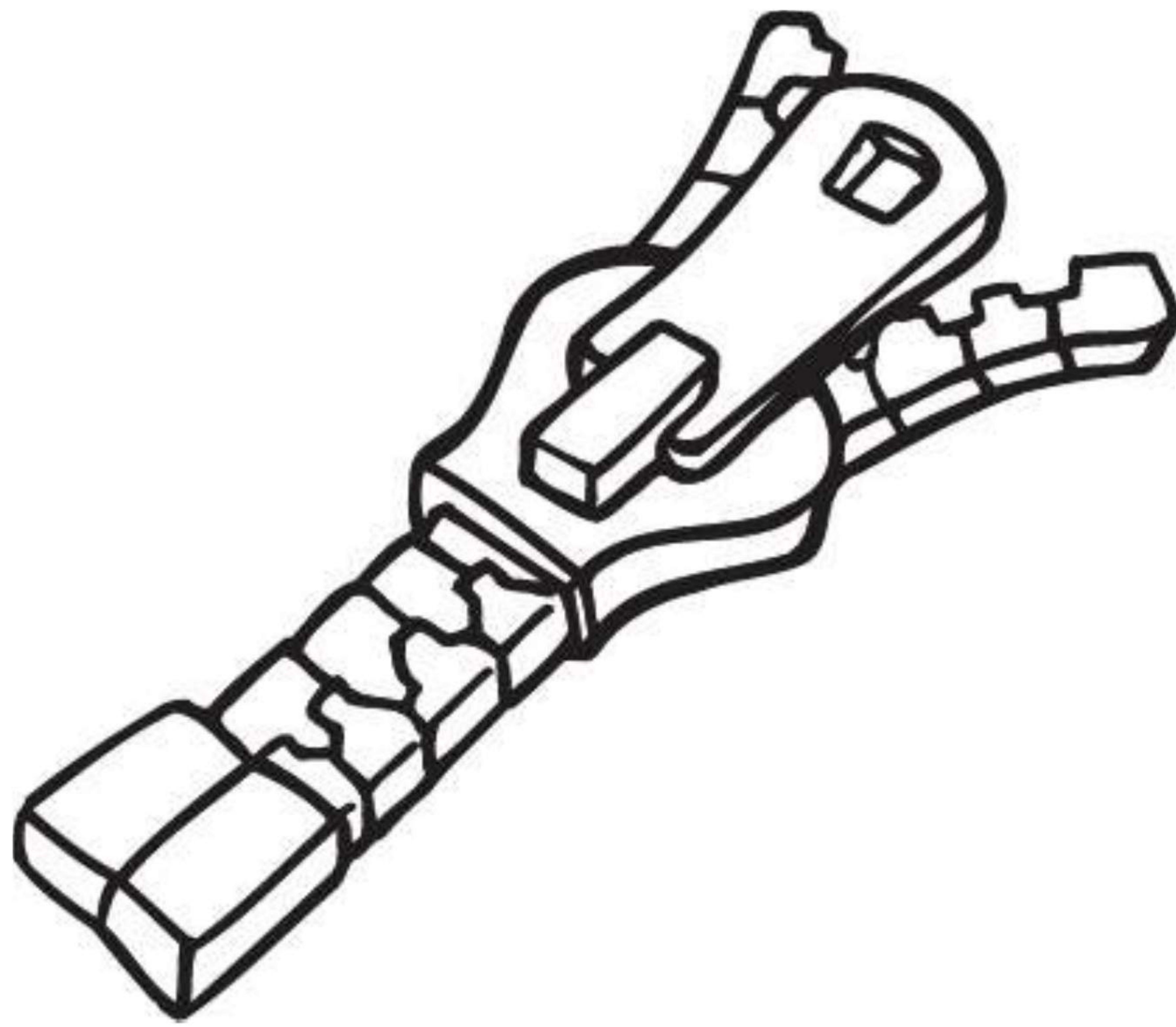

zipper

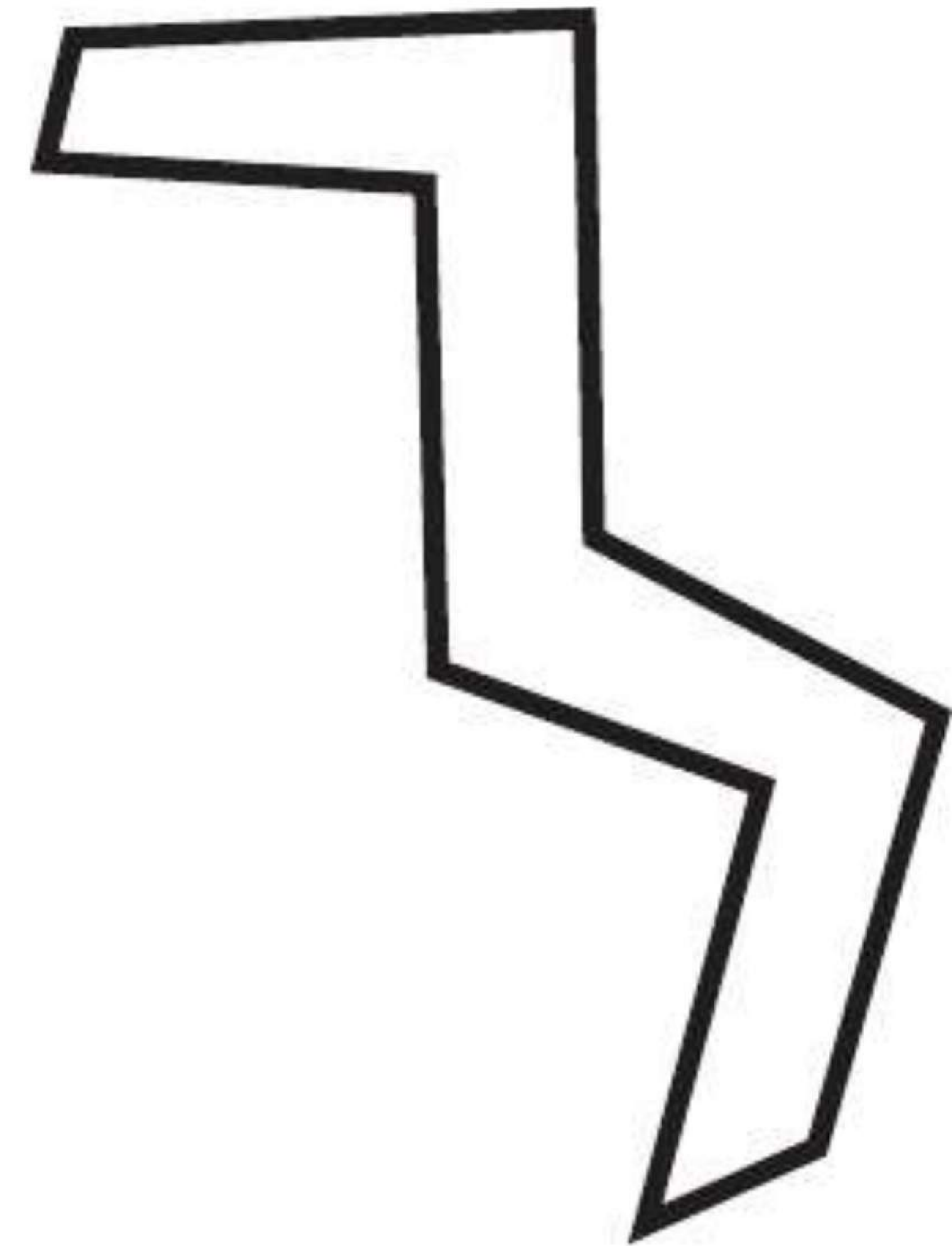

zig zag

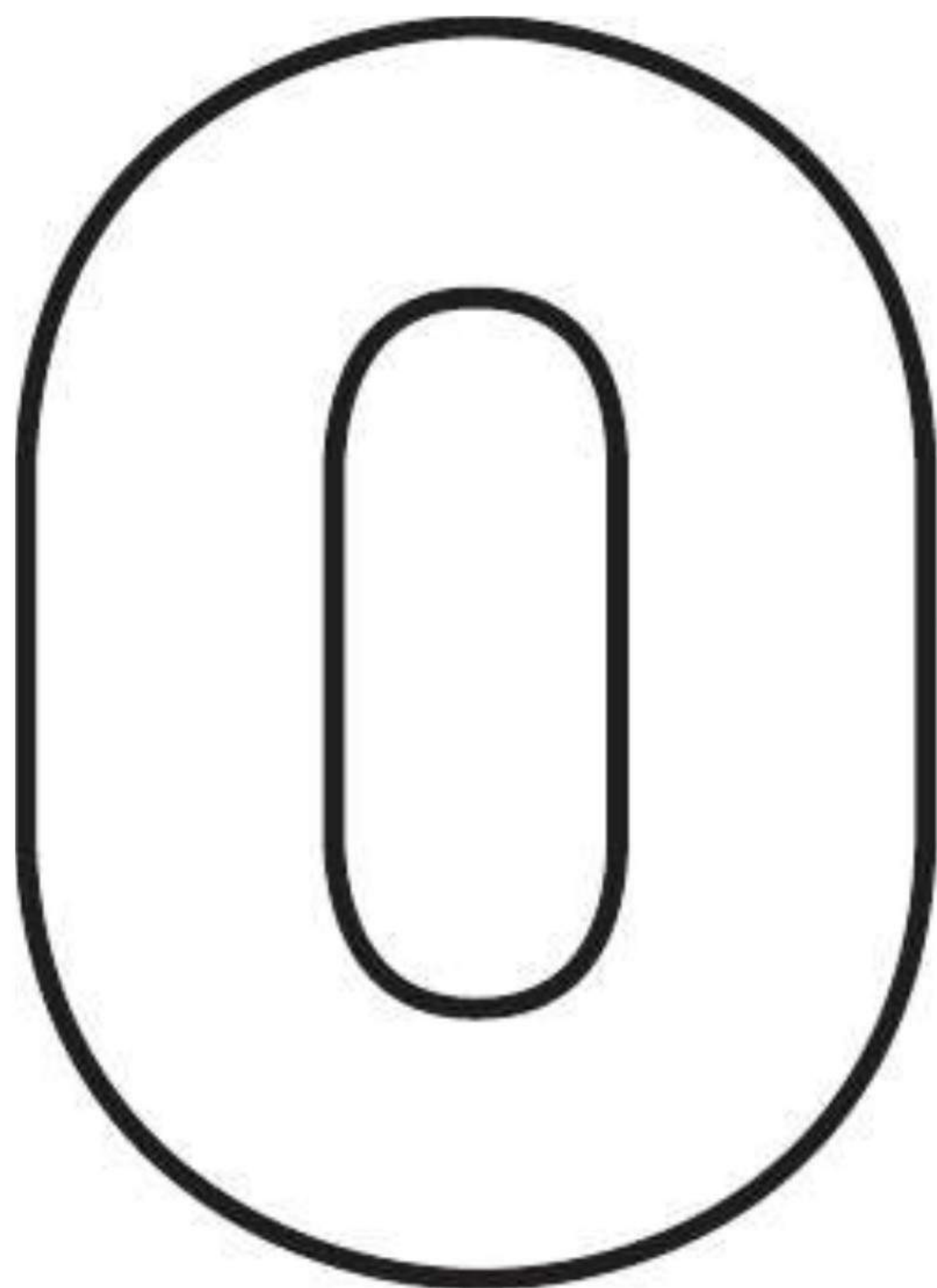

zero



zebra



Beginning Consonants: Xx, Yy, Zz

Directions: Say the sound the letters make. Circle the pictures in each row that begin with the letter shown.

Xx



Yy









Zz





Review: Beginning Consonants

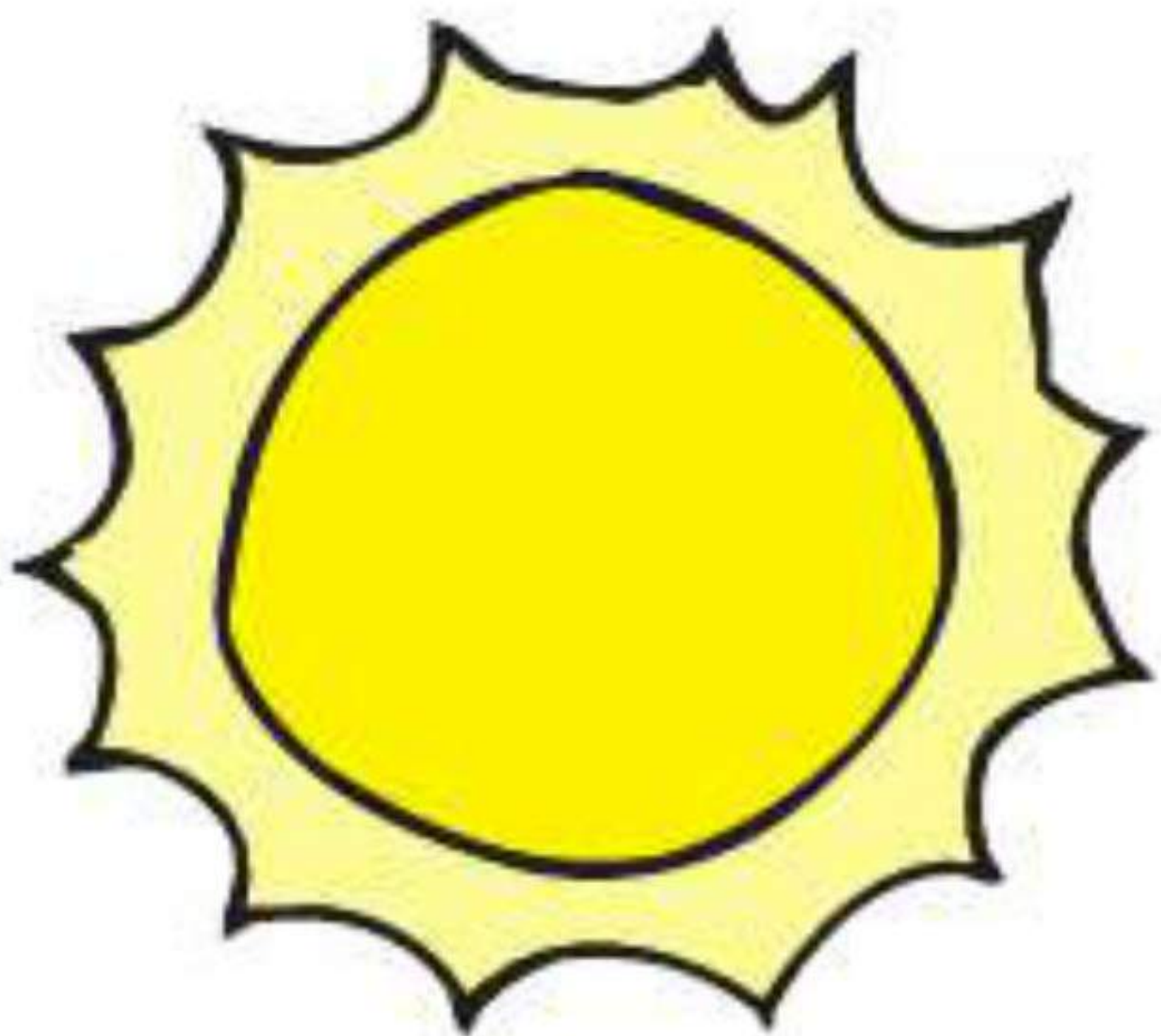
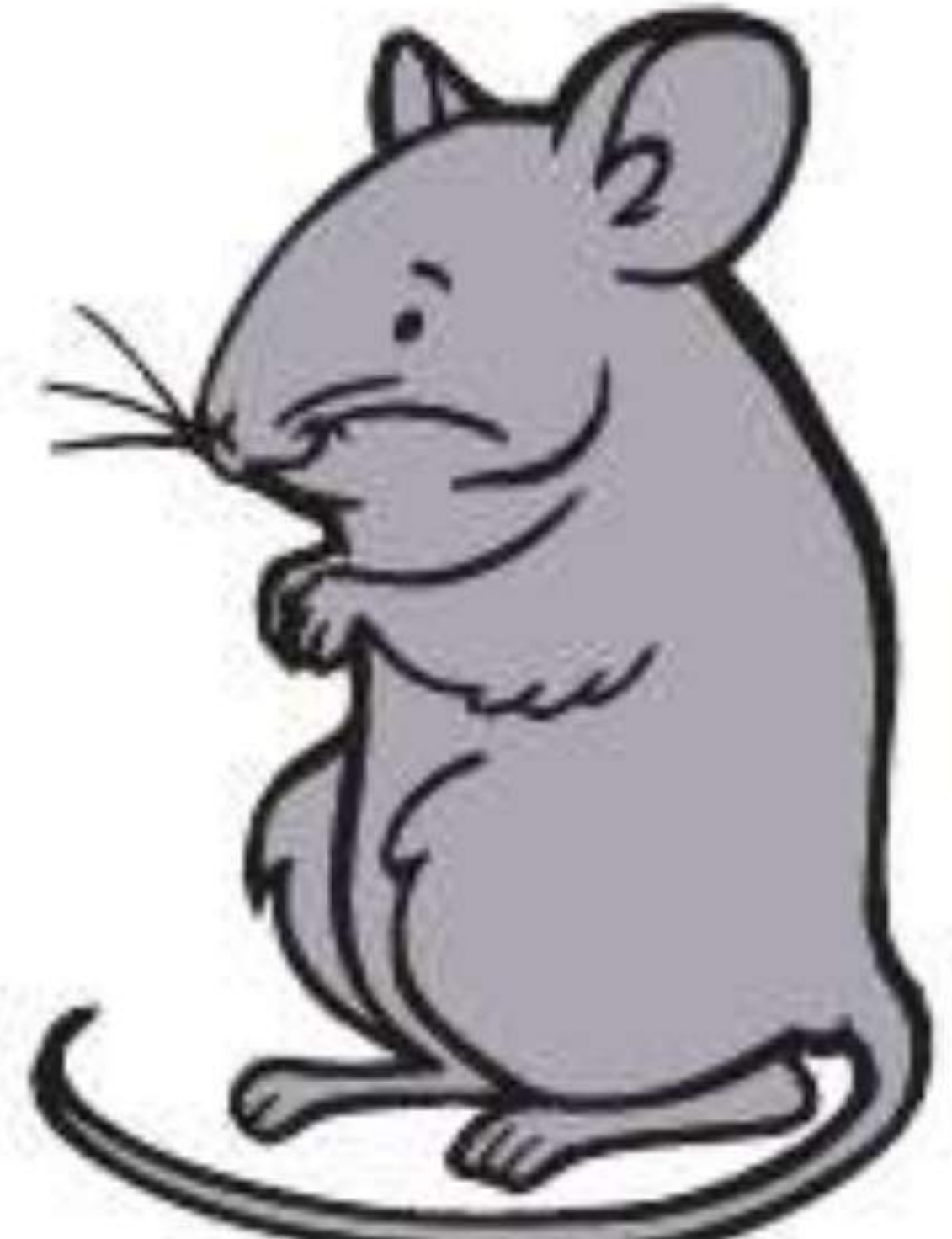
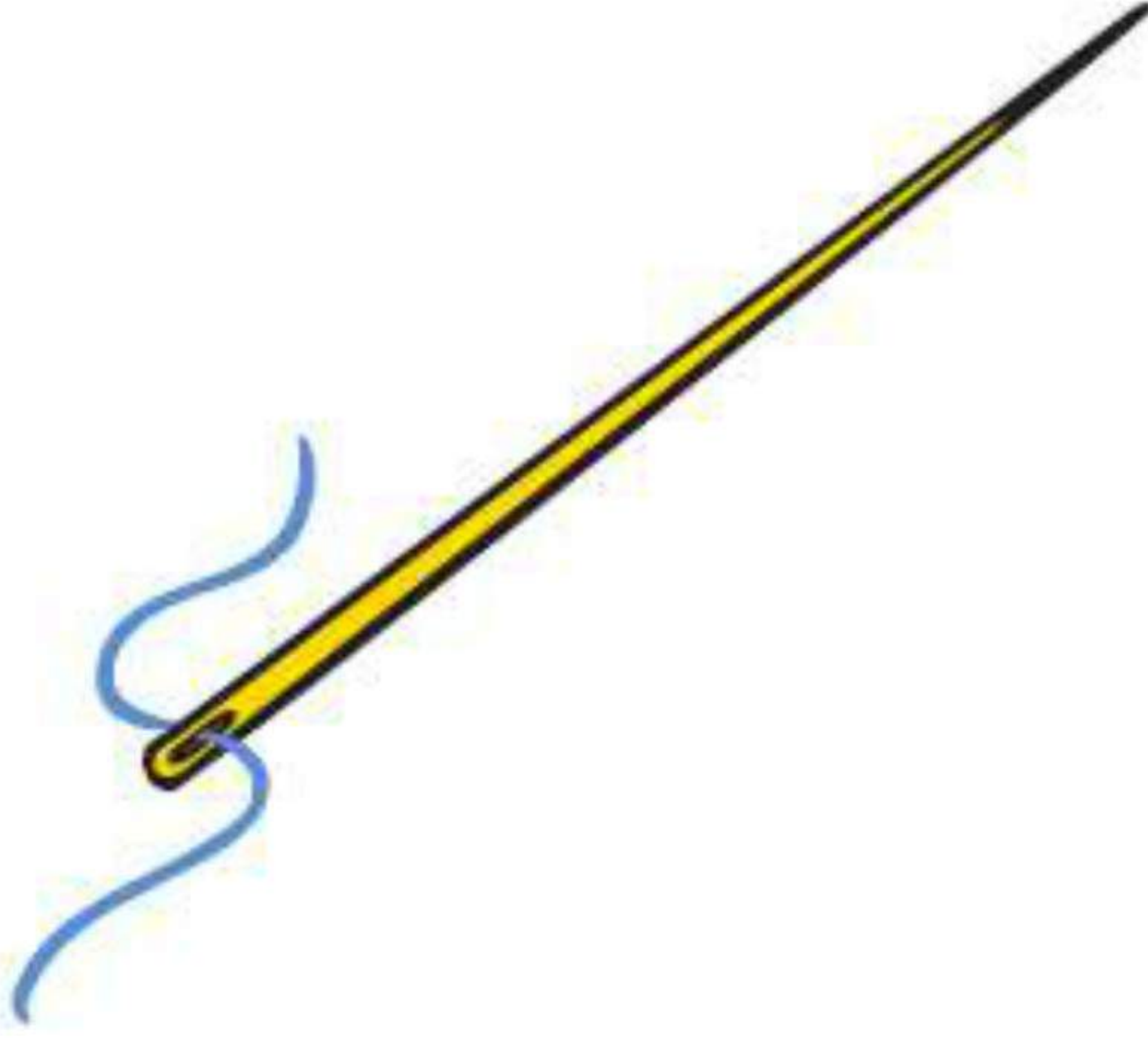
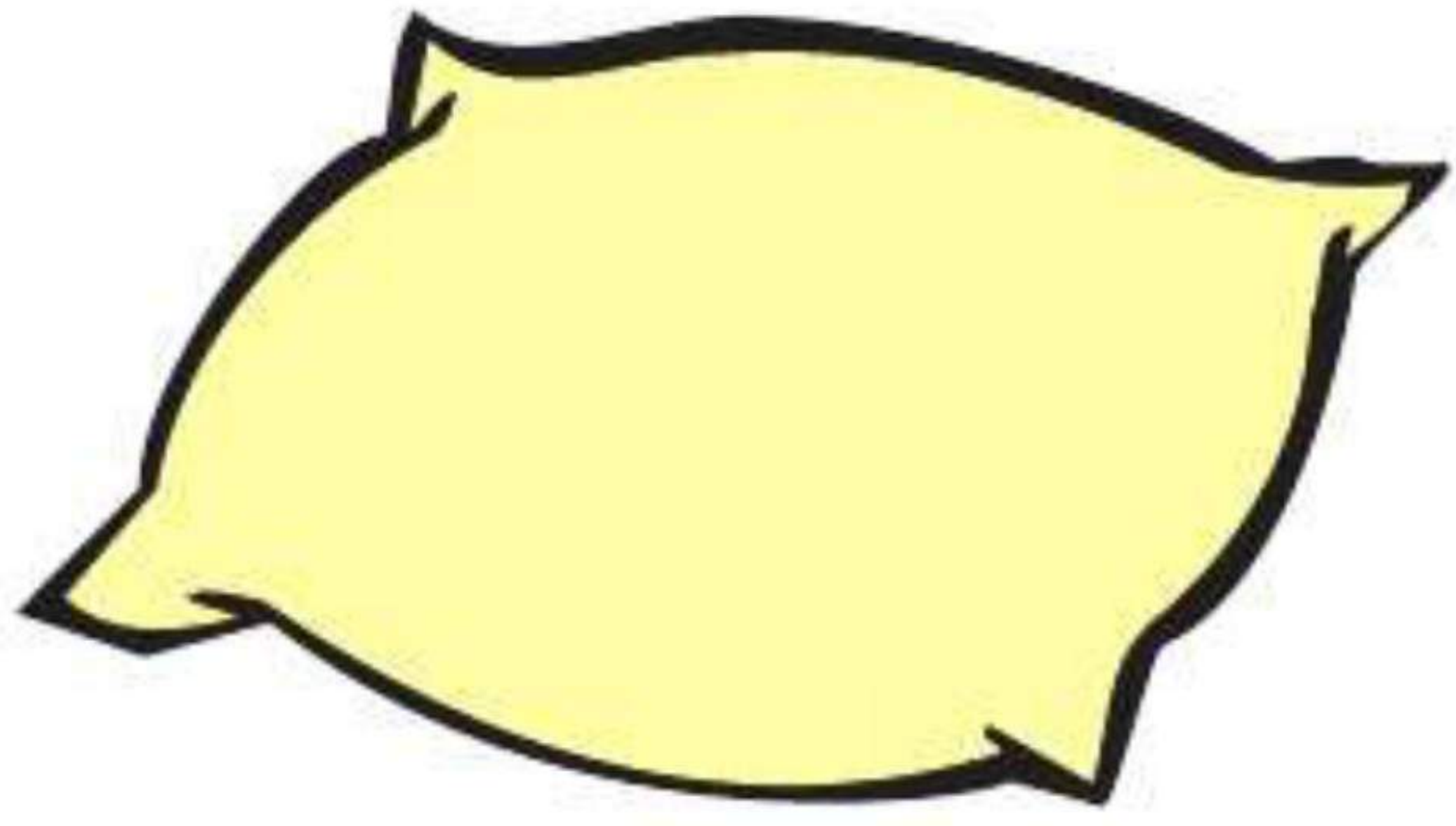



Directions: Say each picture name. Circle the beginning sound.

 r n	 m f	 k b
 l h	 s w	 d m
 n d	 l p	 y w

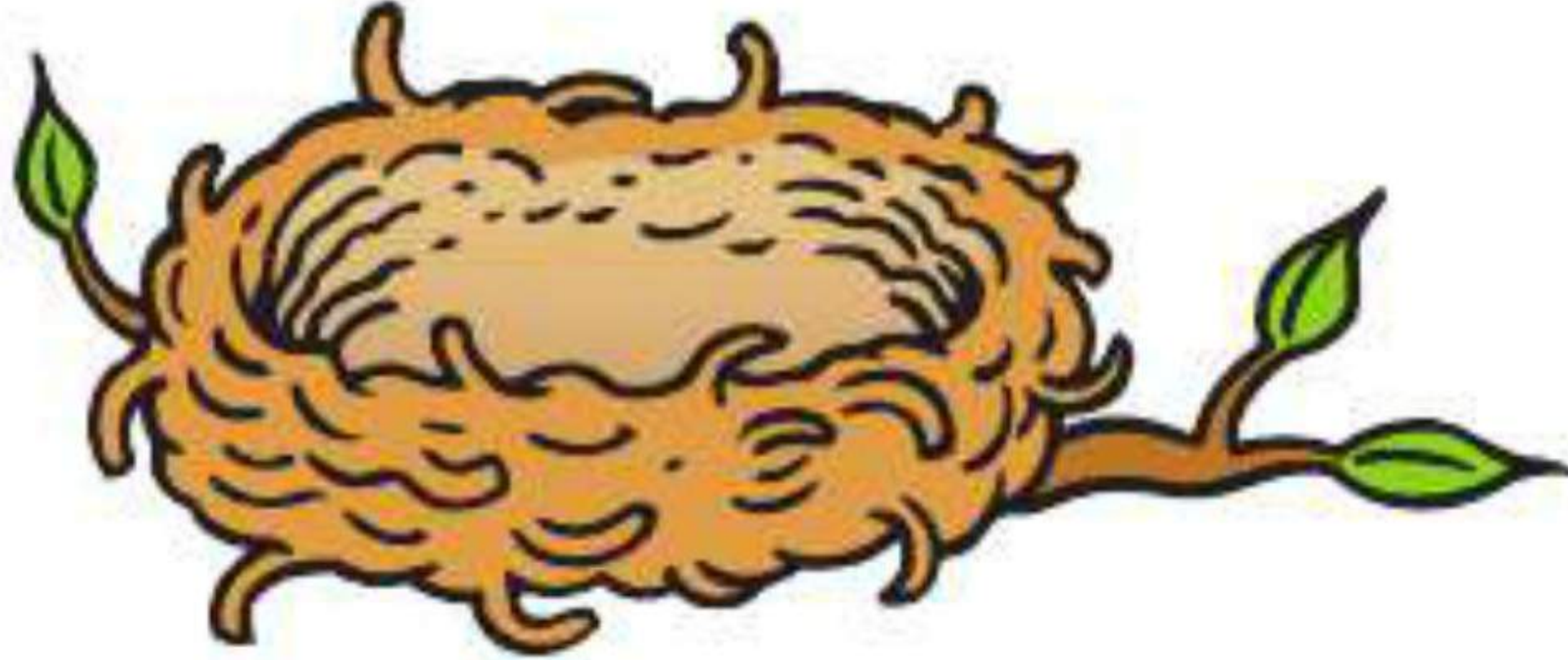
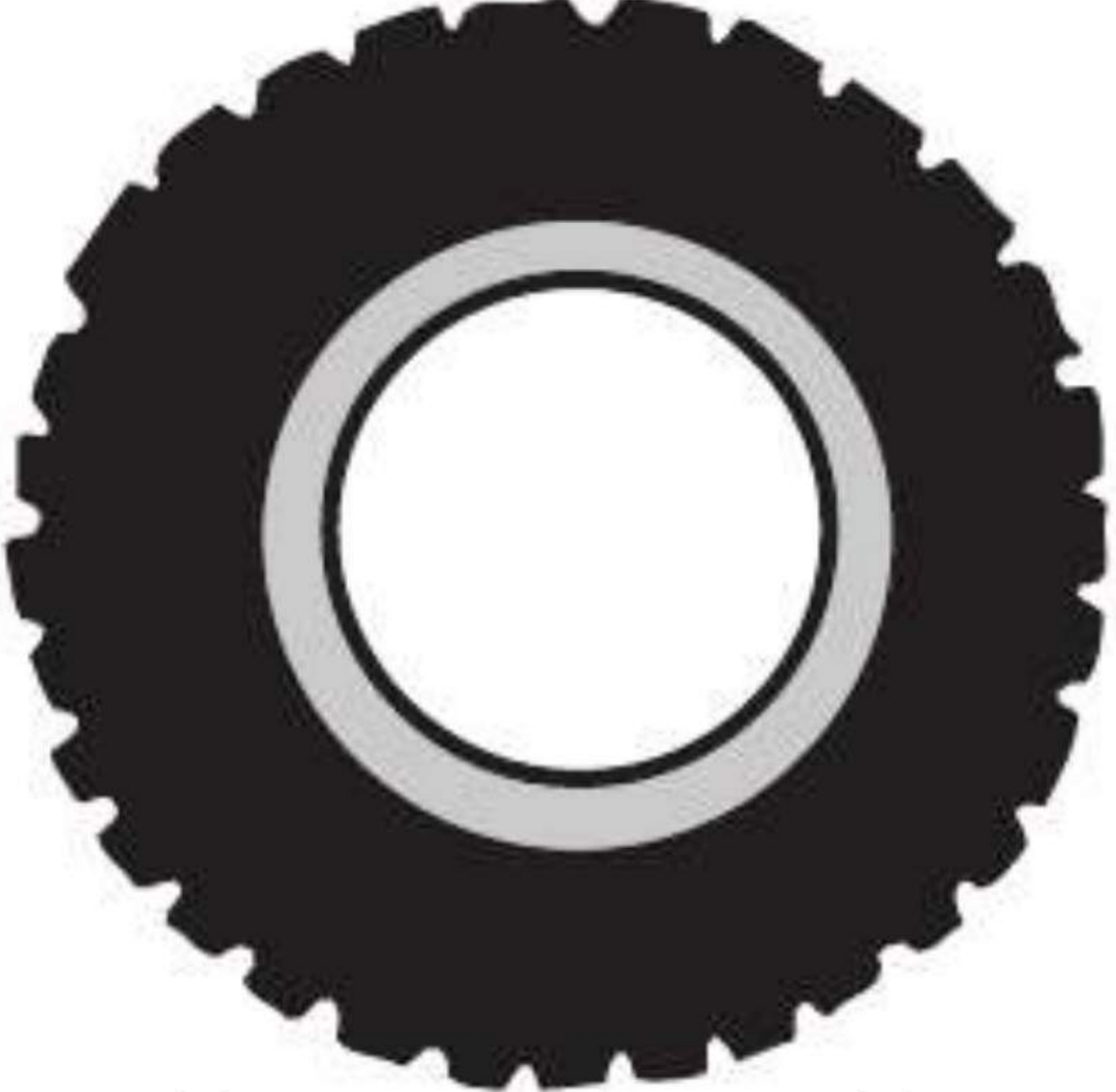
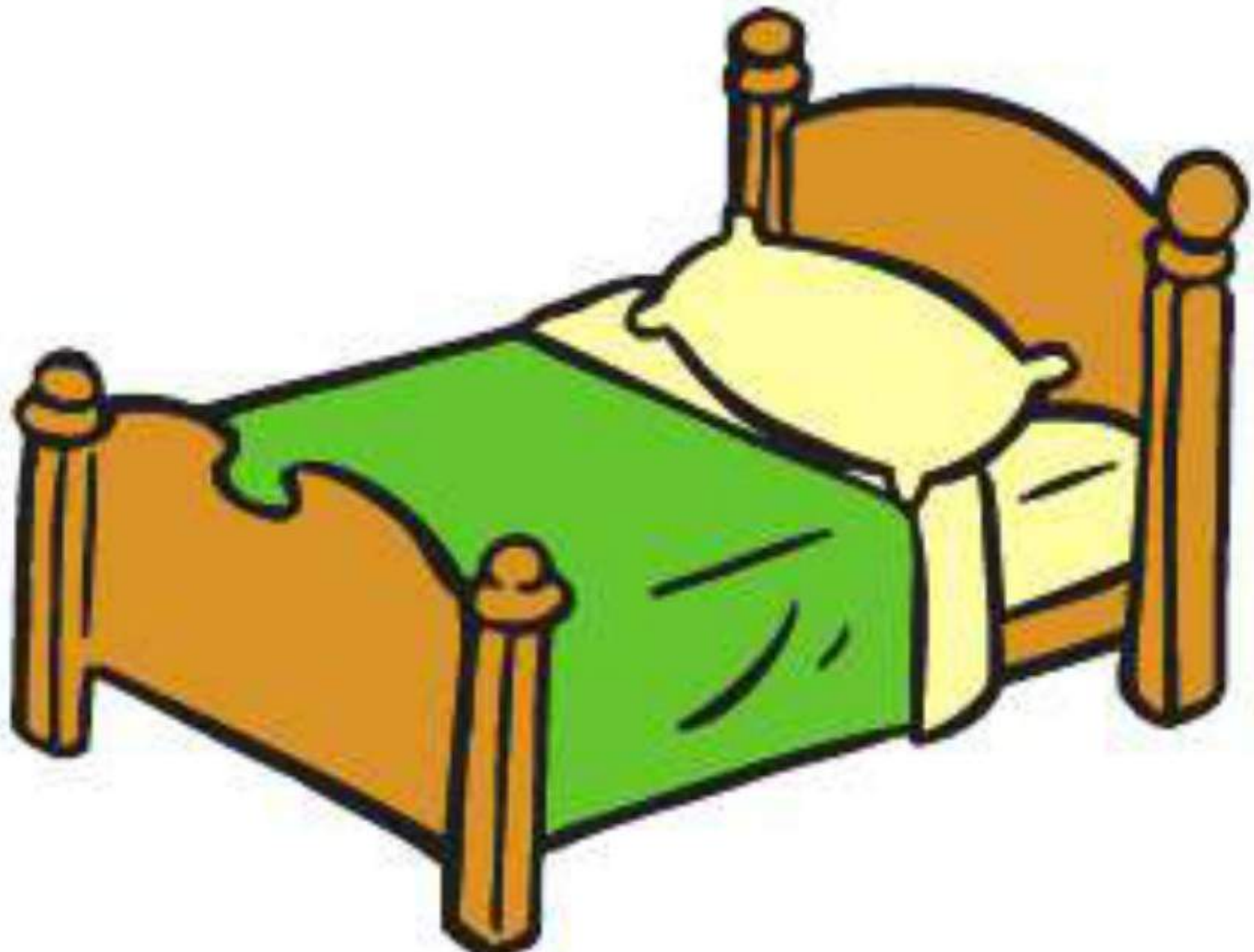

Review: Beginning Consonants



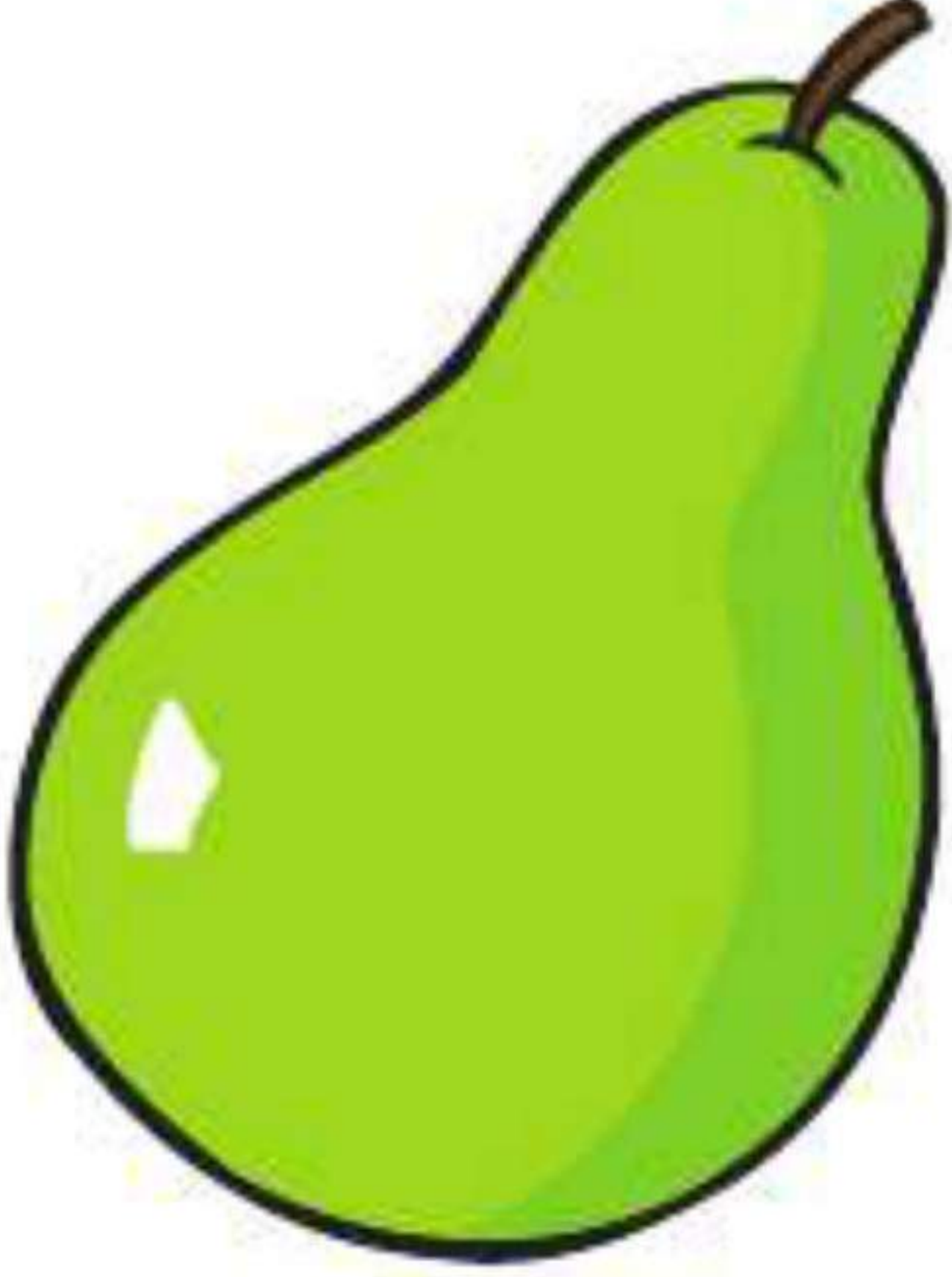
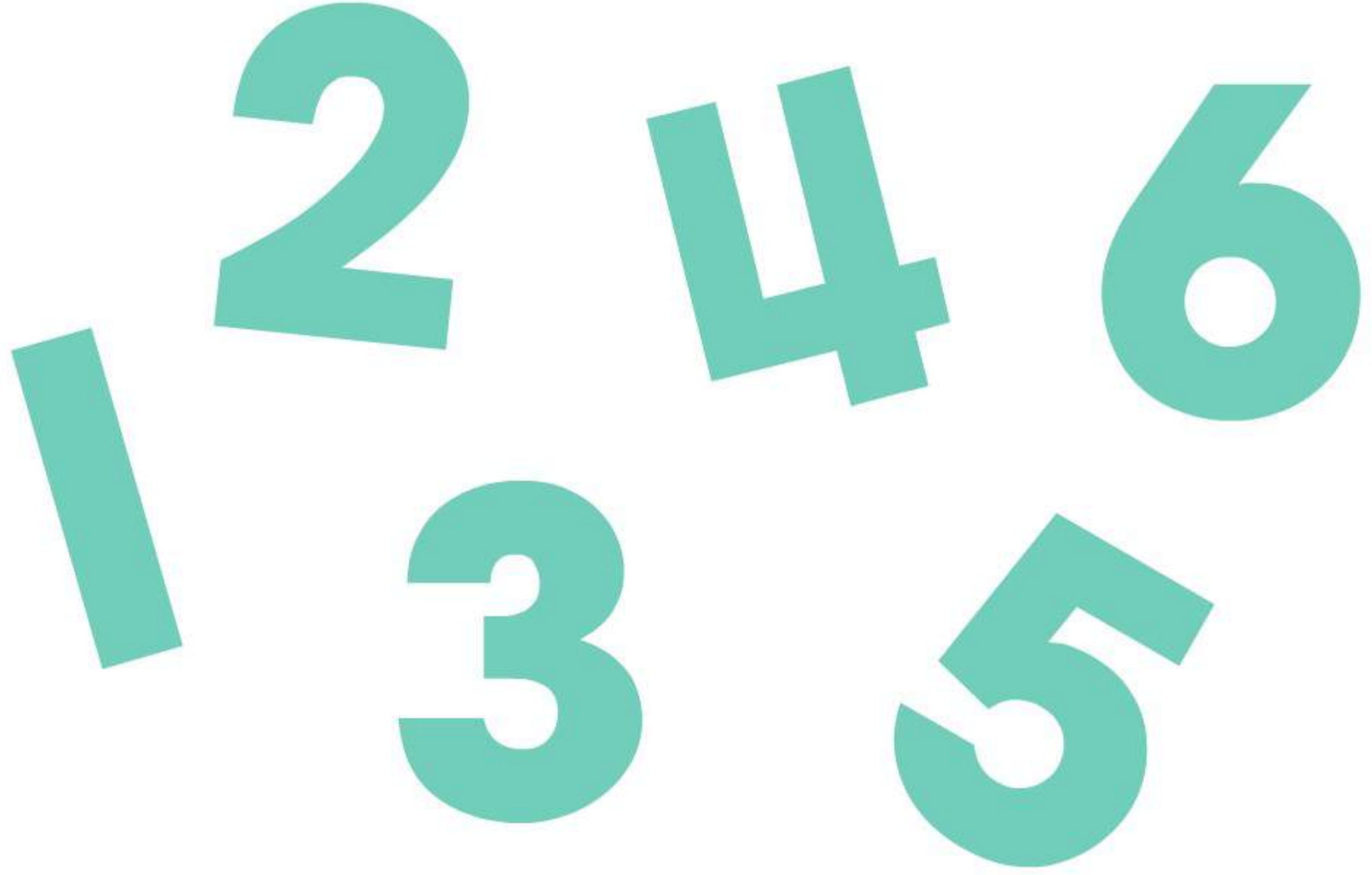



Directions: Say each picture name. Circle the beginning sound.

 t p	 n c	 b t
 b c	 t p	 c b
 c t	 b p	 p n

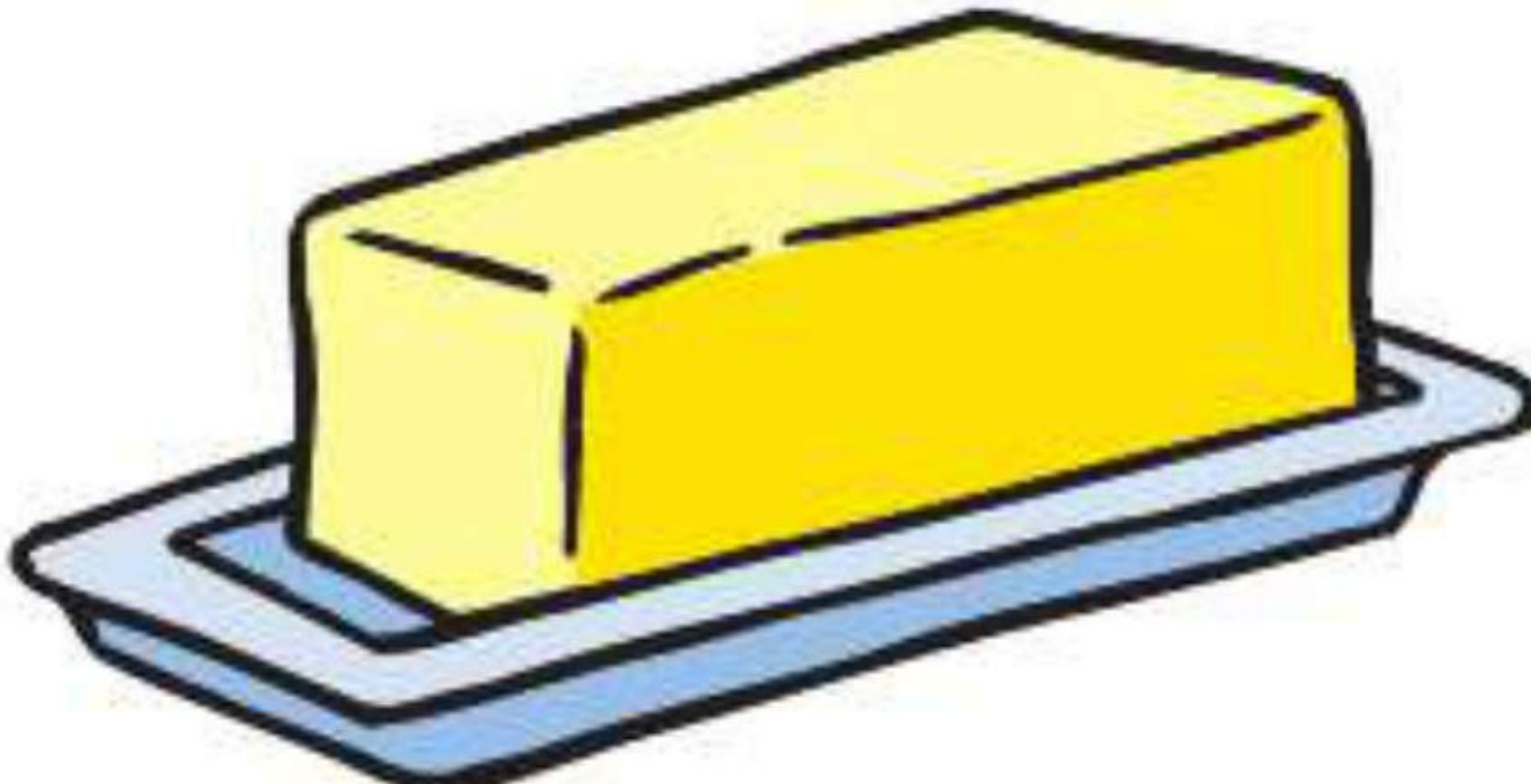

Review: Beginning Consonants

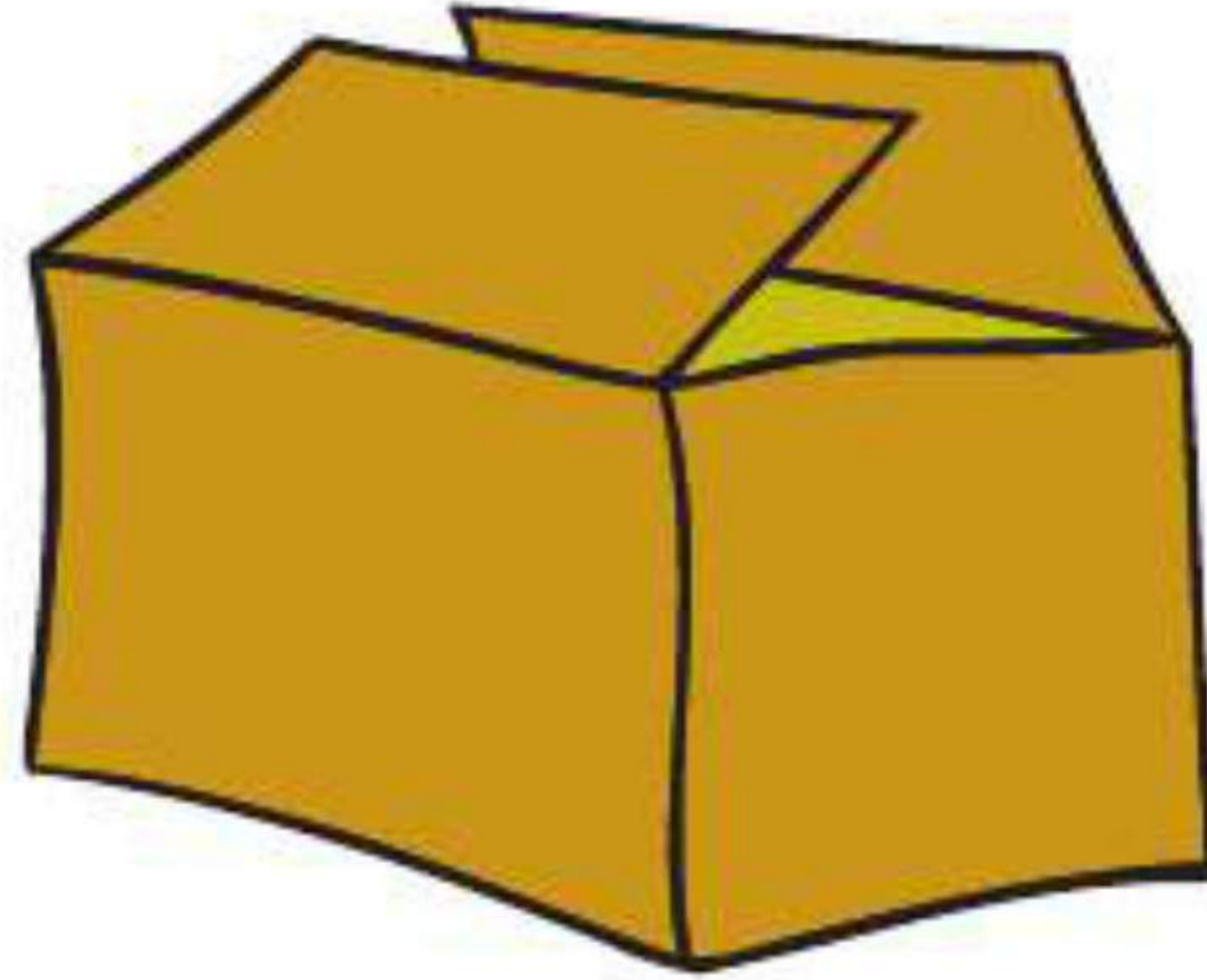
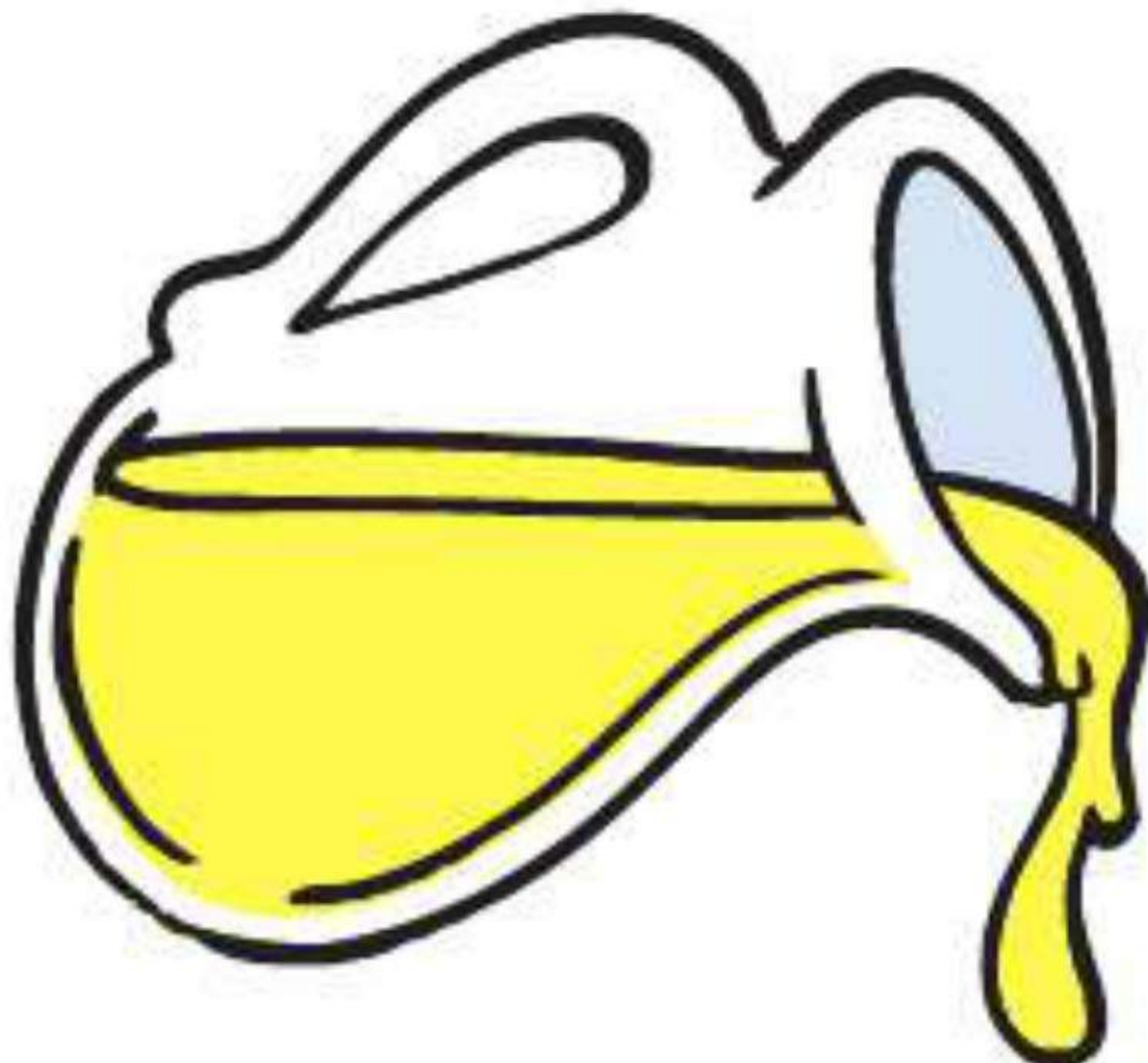
Directions: Say each picture name. Circle the beginning sound.

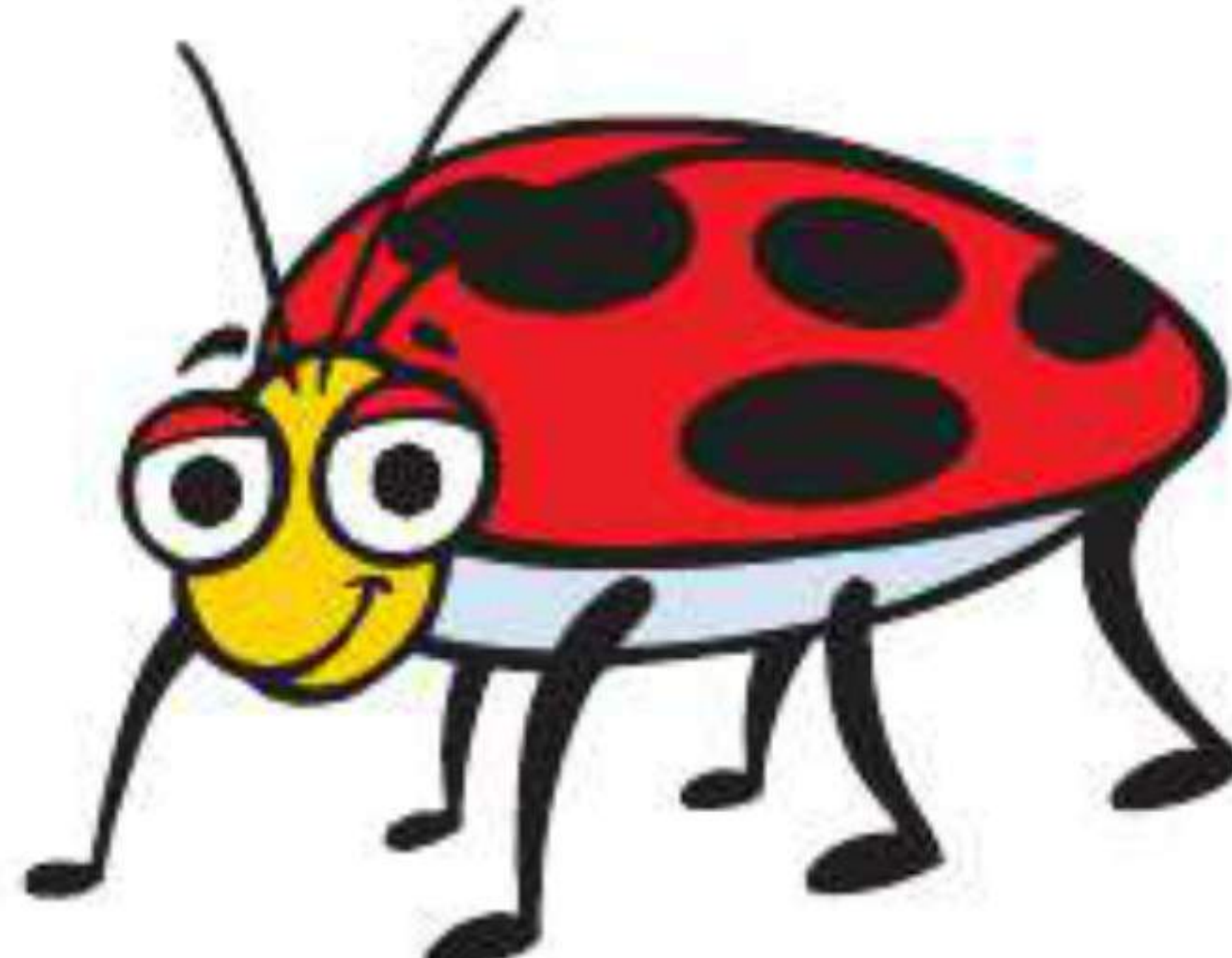
 <p>p t</p>	 <p>b p</p>	 <p>n c</p>
 <p>n b</p>	 <p>t n</p>	 <p>t b</p>
 <p>p b</p>	 <p>c p</p>	 <p>c b</p>



Review: Beginning Consonants

Directions: Say the sound the letter makes. Circle the pictures in each row that begin with the letter shown.

b



c

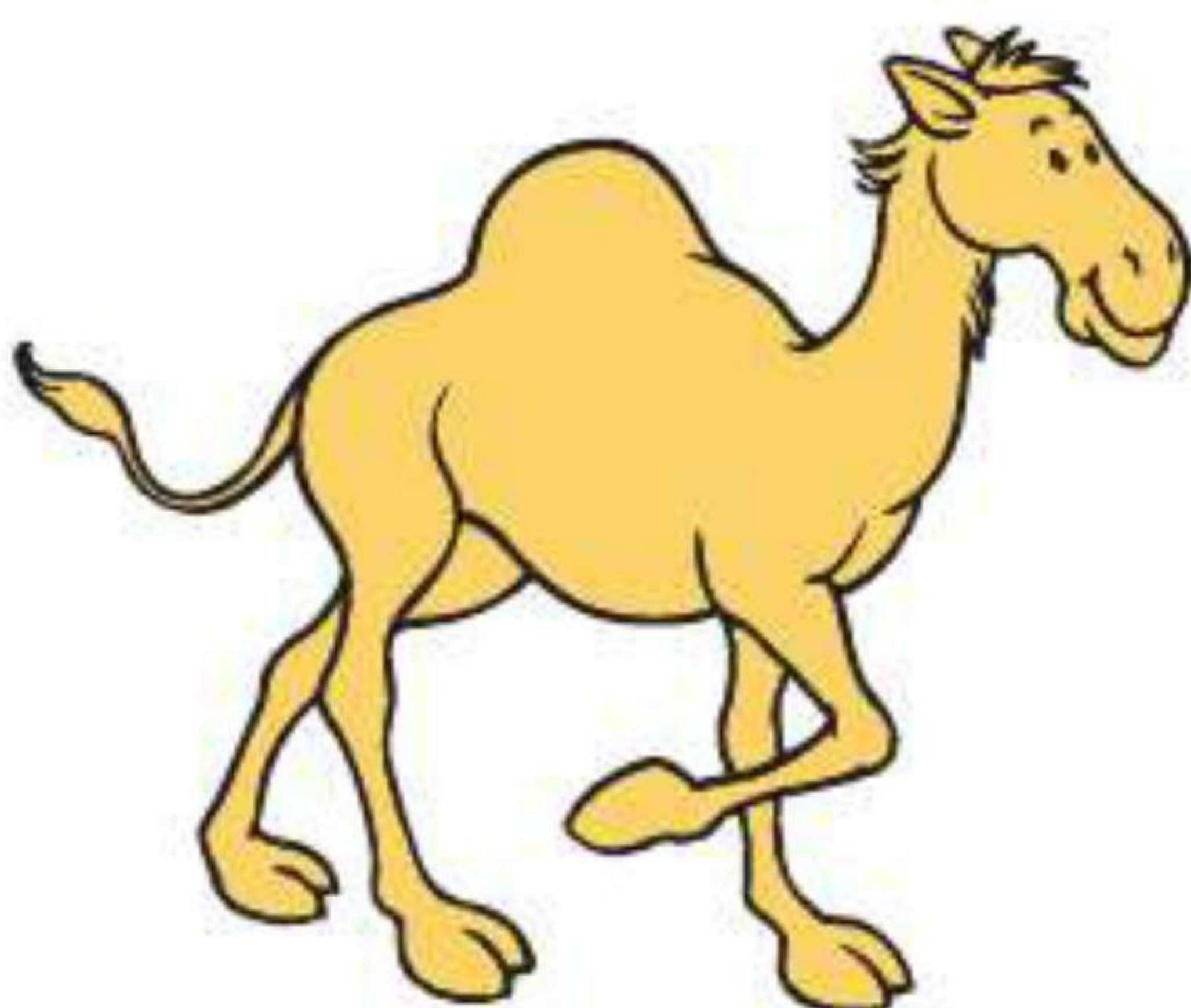

t

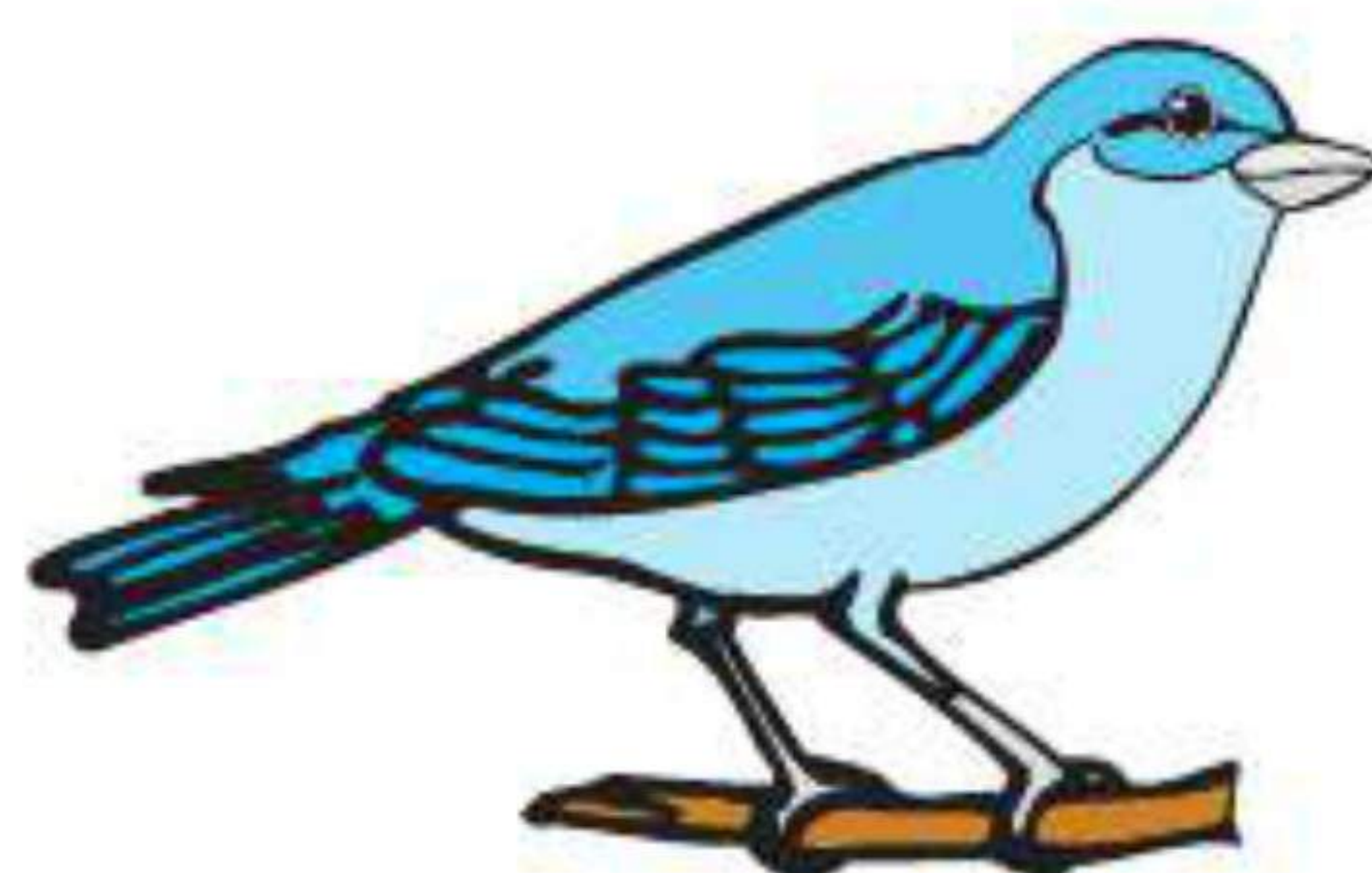

n

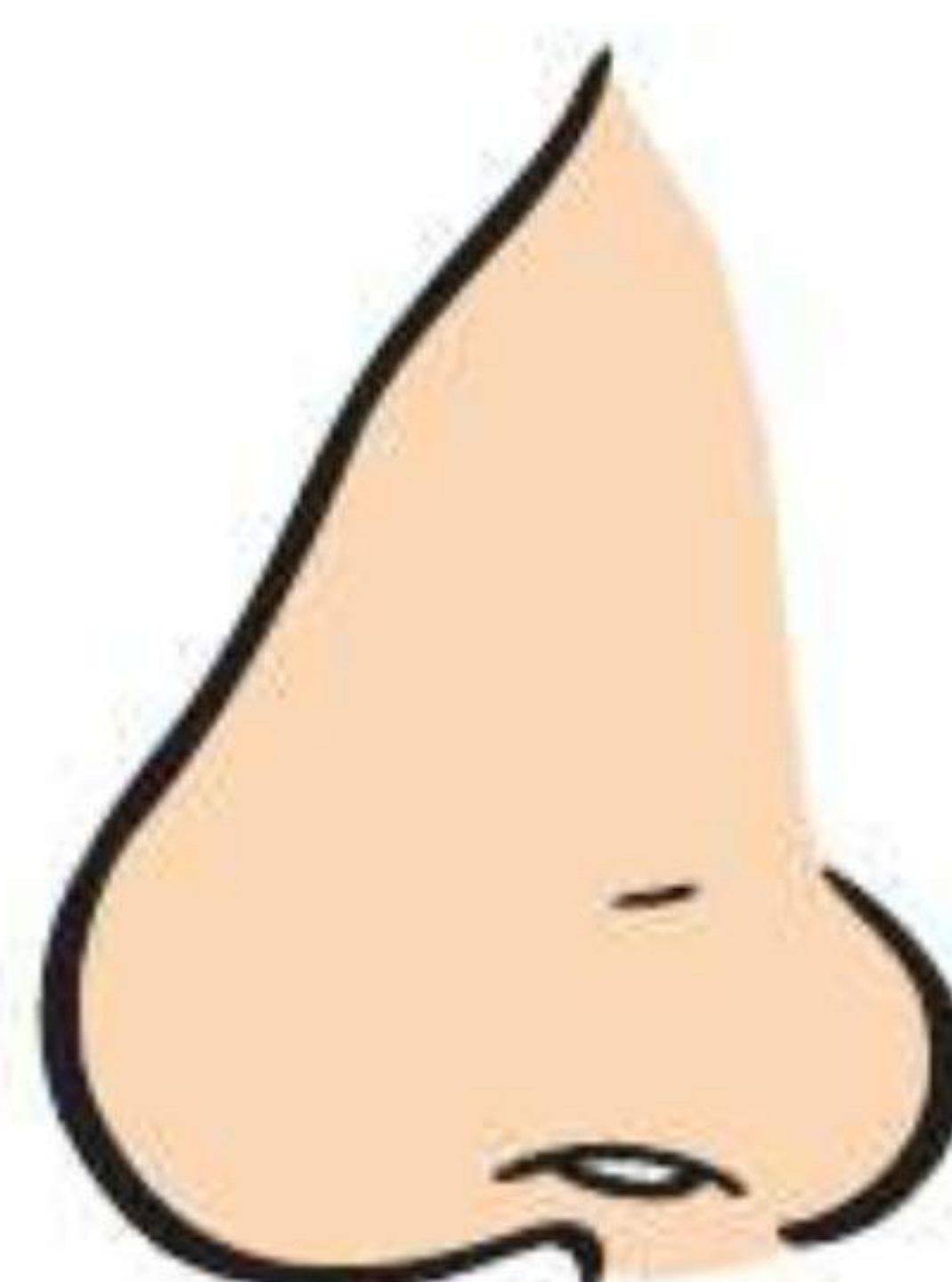



Review: Beginning Consonants

Directions: Look at the letter in each column. Cut out each picture and glue it under the correct beginning sound.

Hh	Dd	Rr	Gg

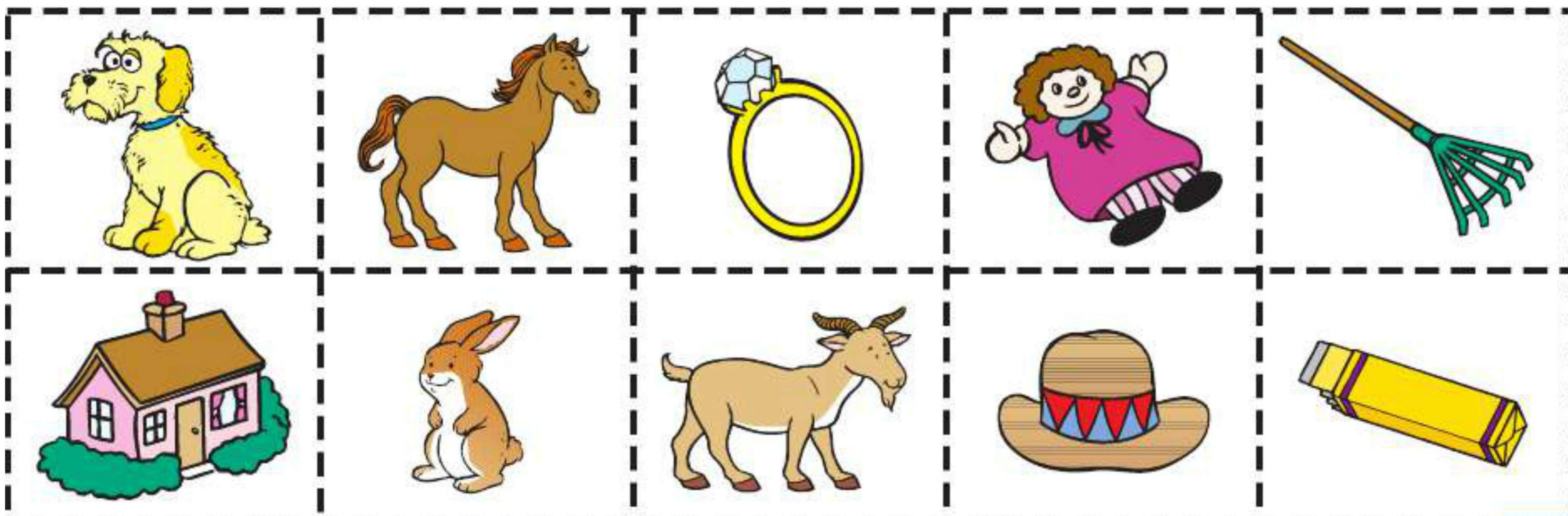



Review: Beginning Consonants

Directions: Look at the letter in each box. Circle the picture that begins with that sound.

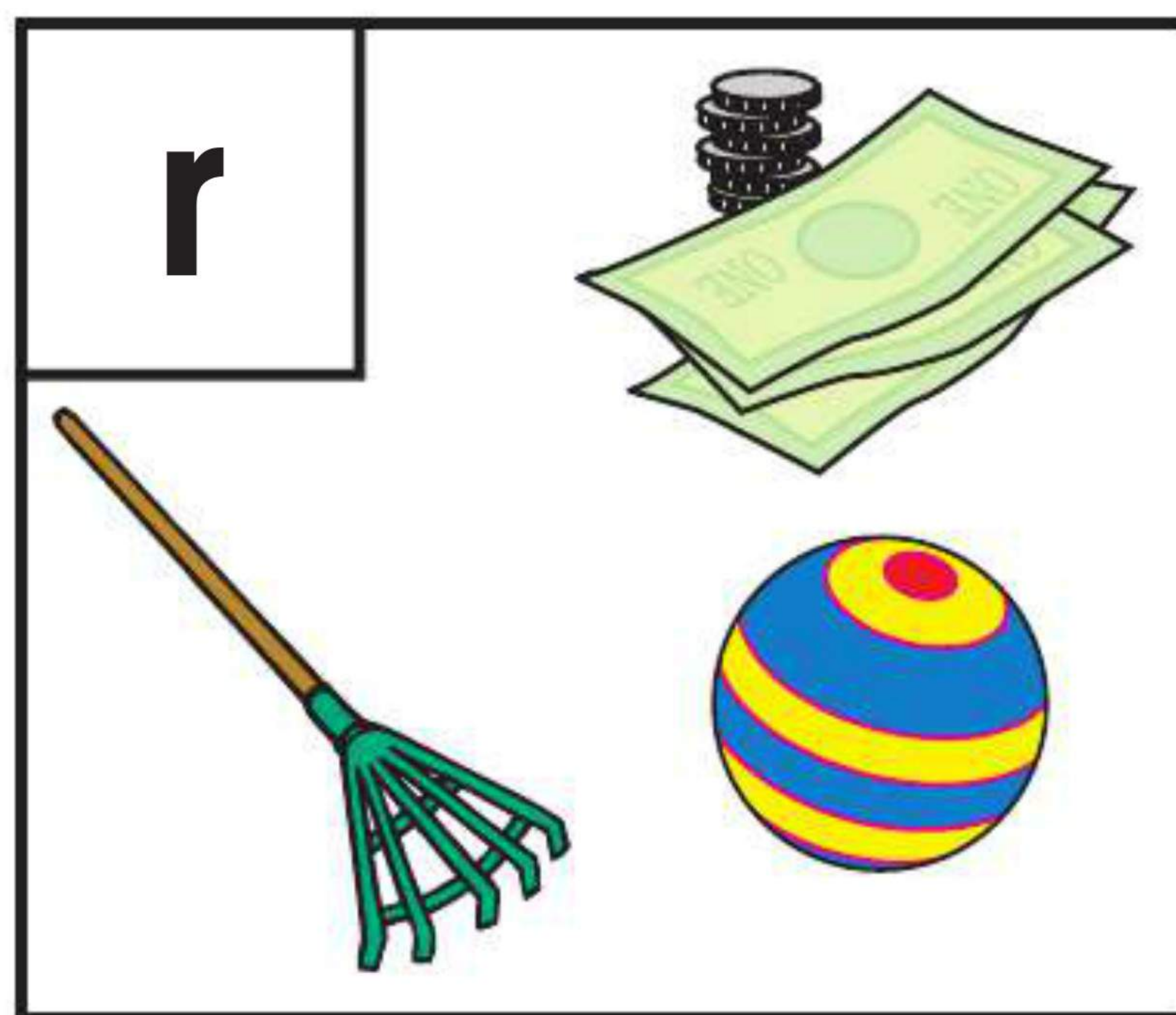
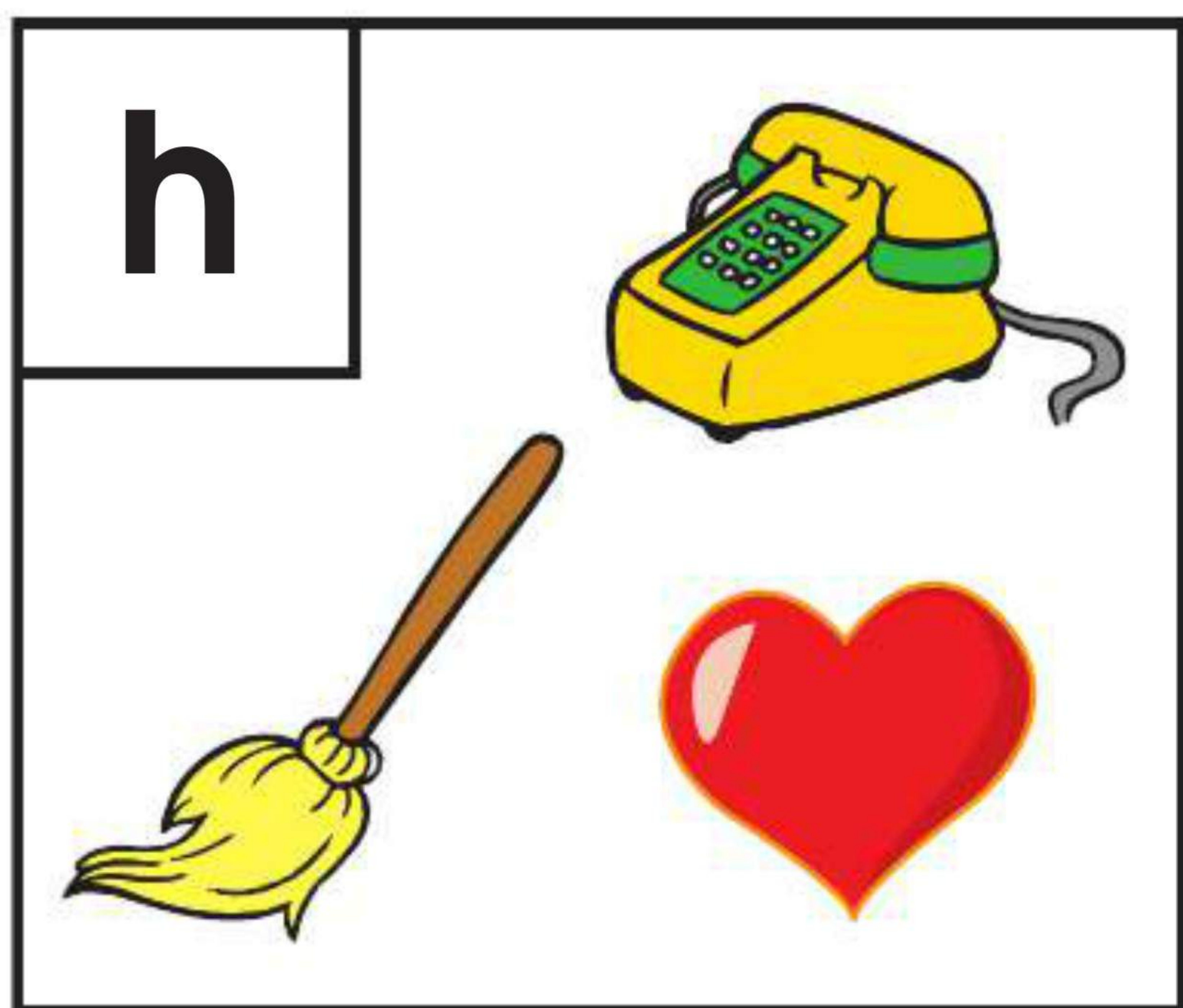
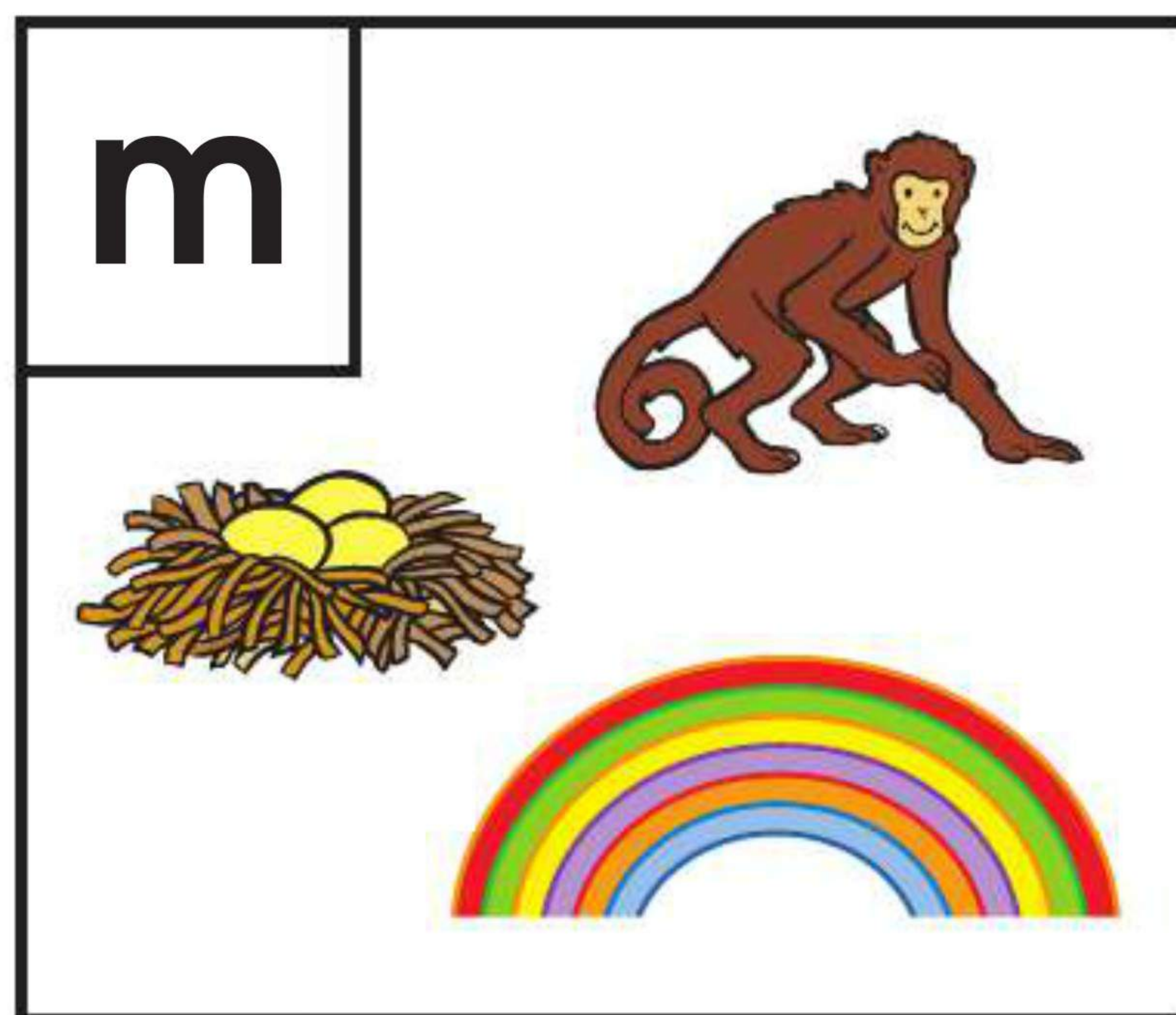
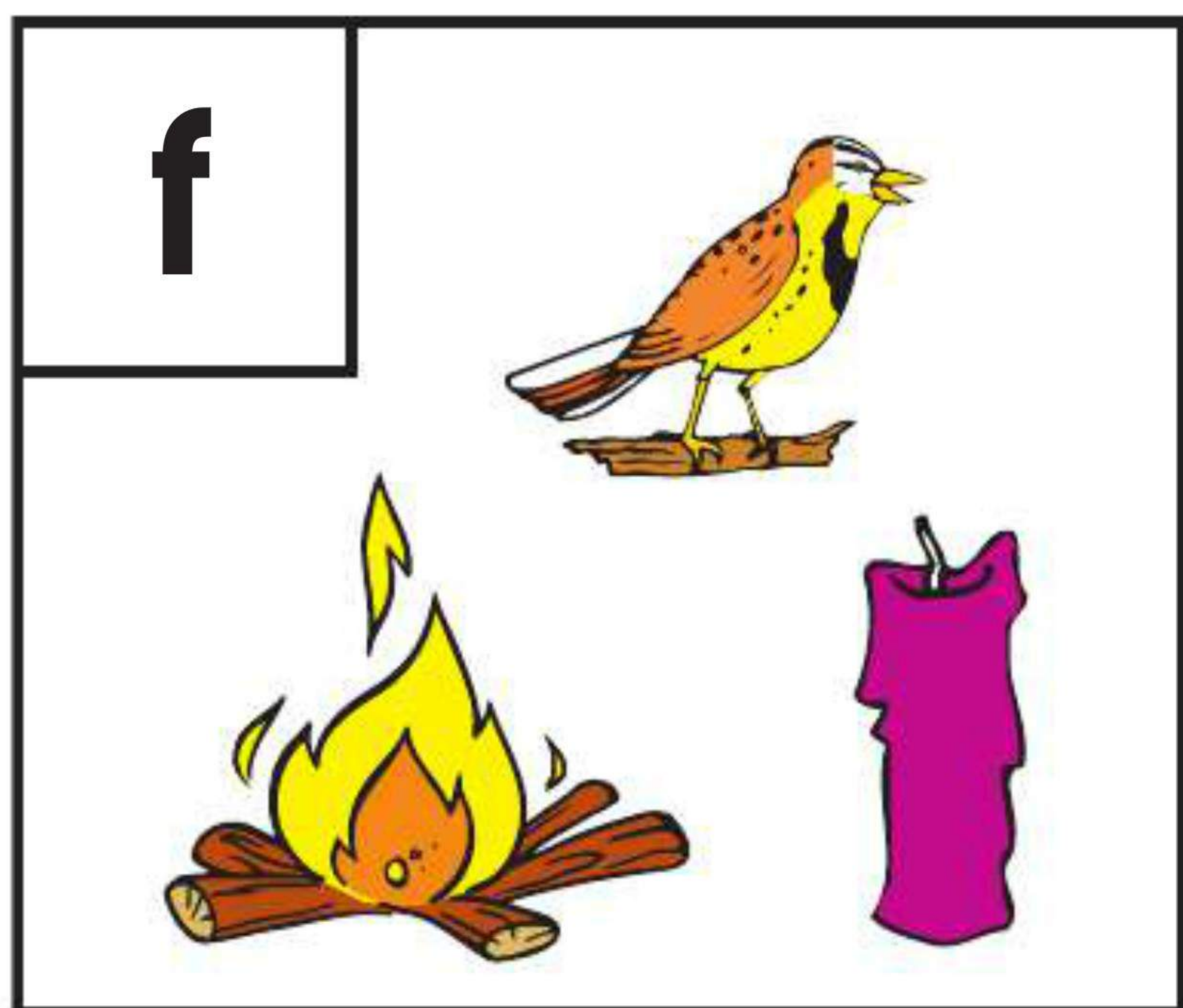
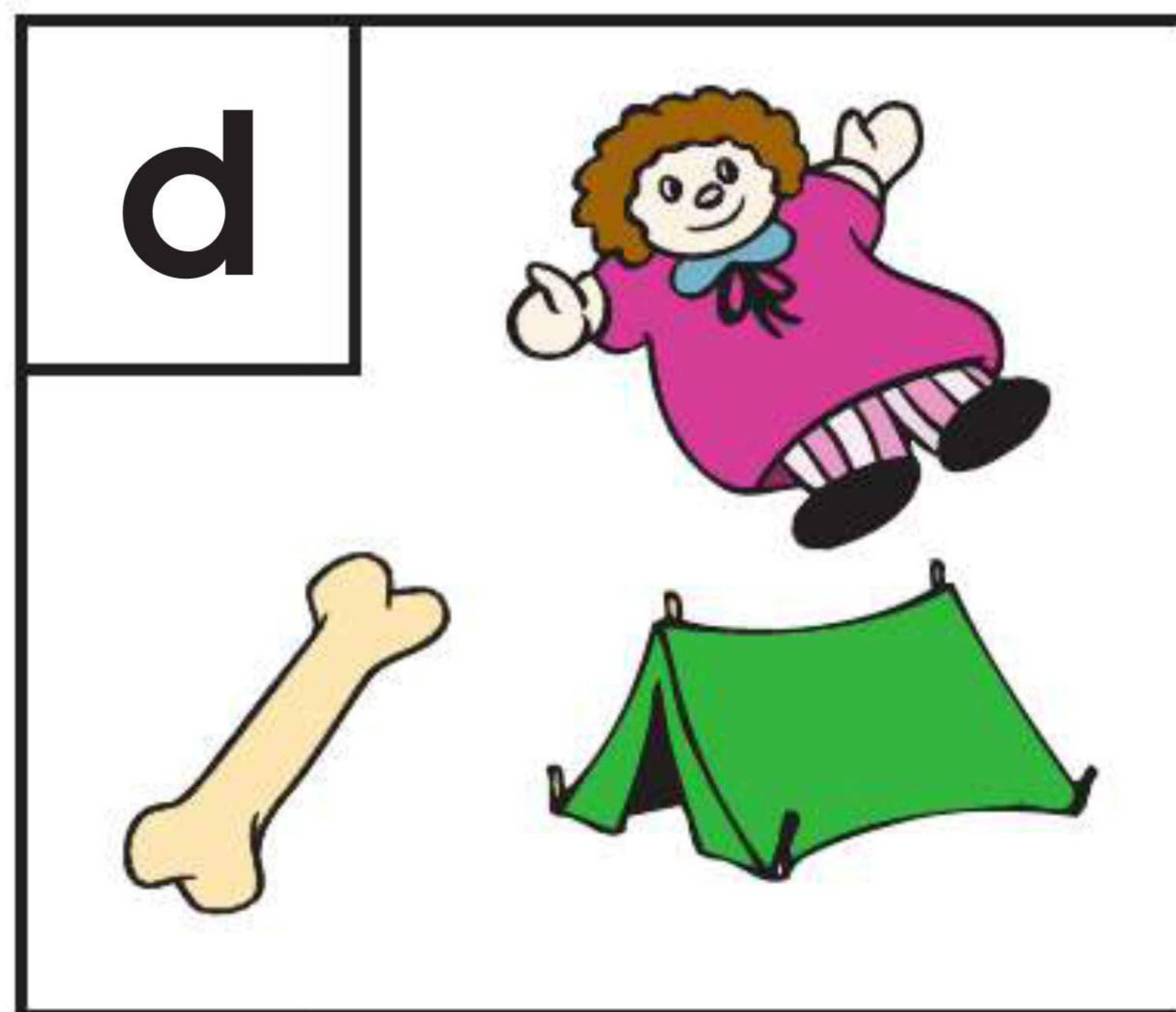
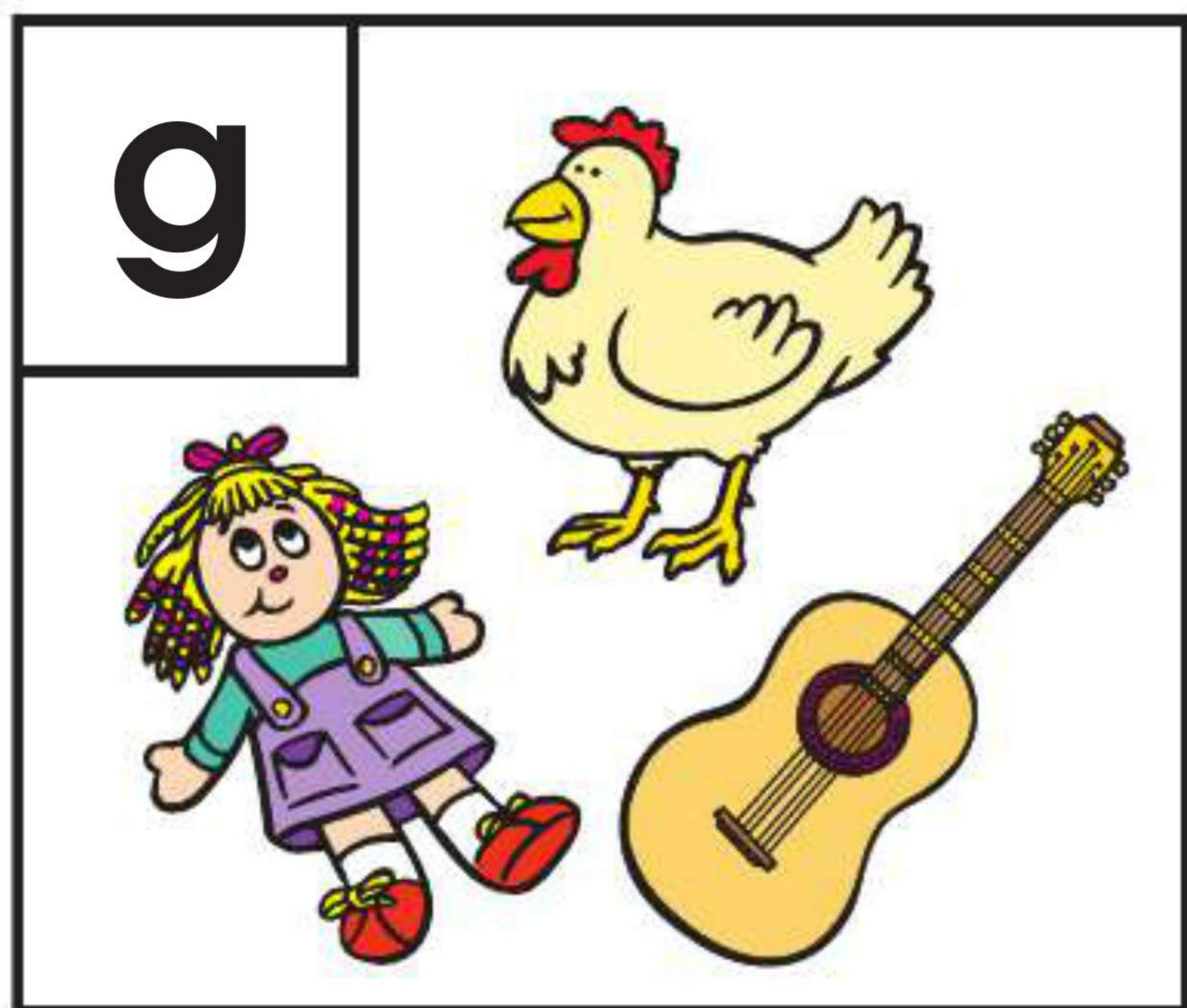



Ending Consonant Sounds



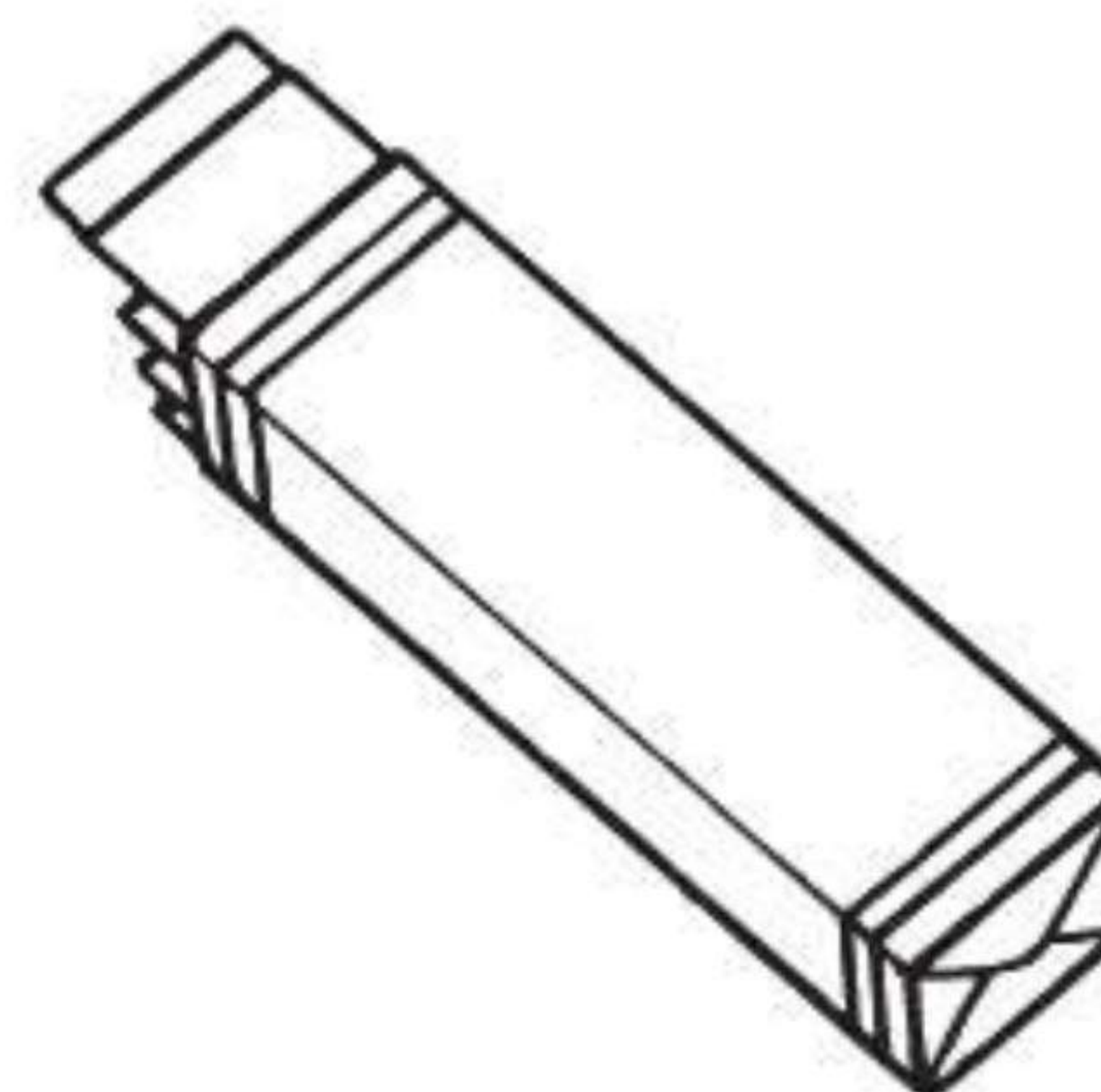
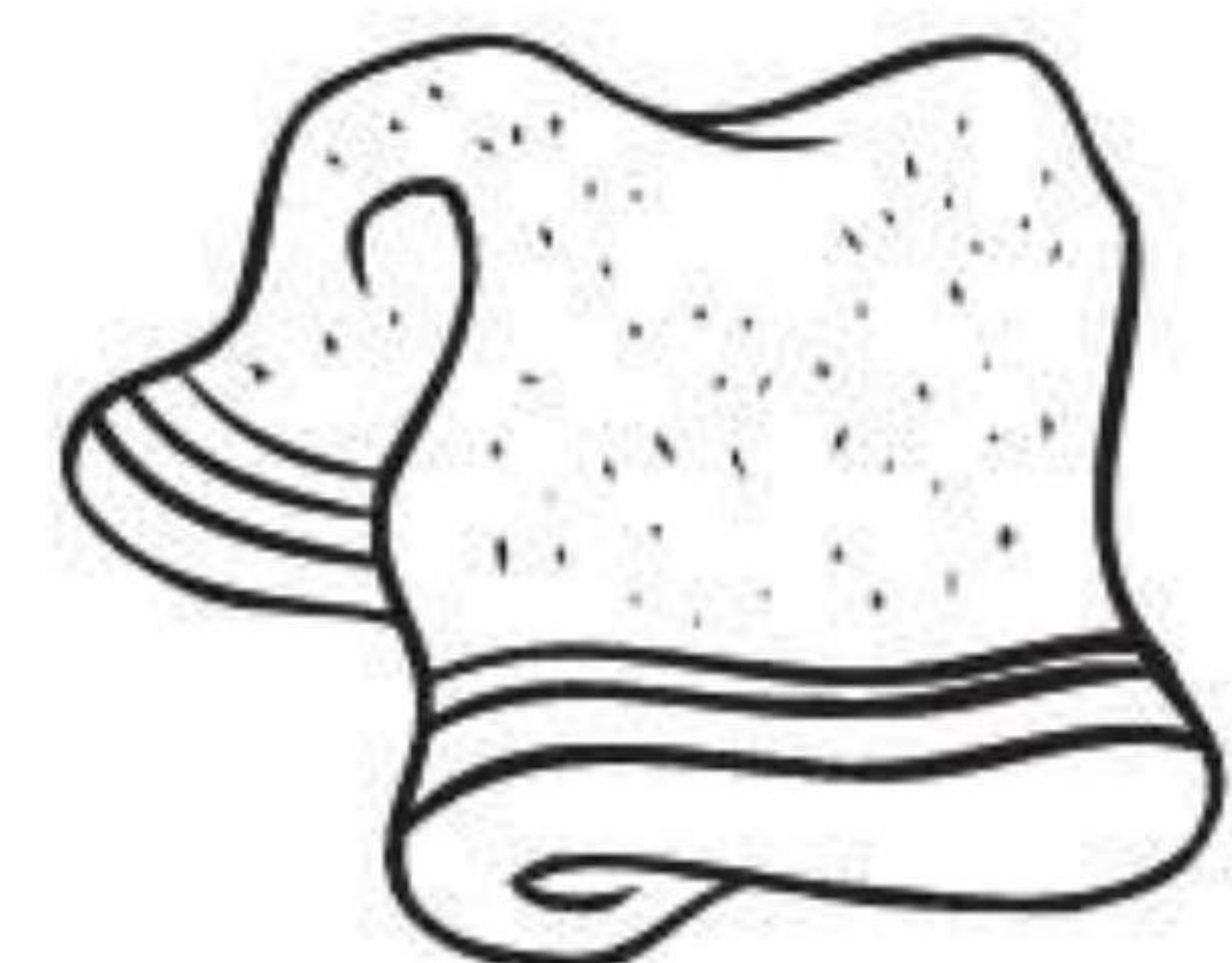
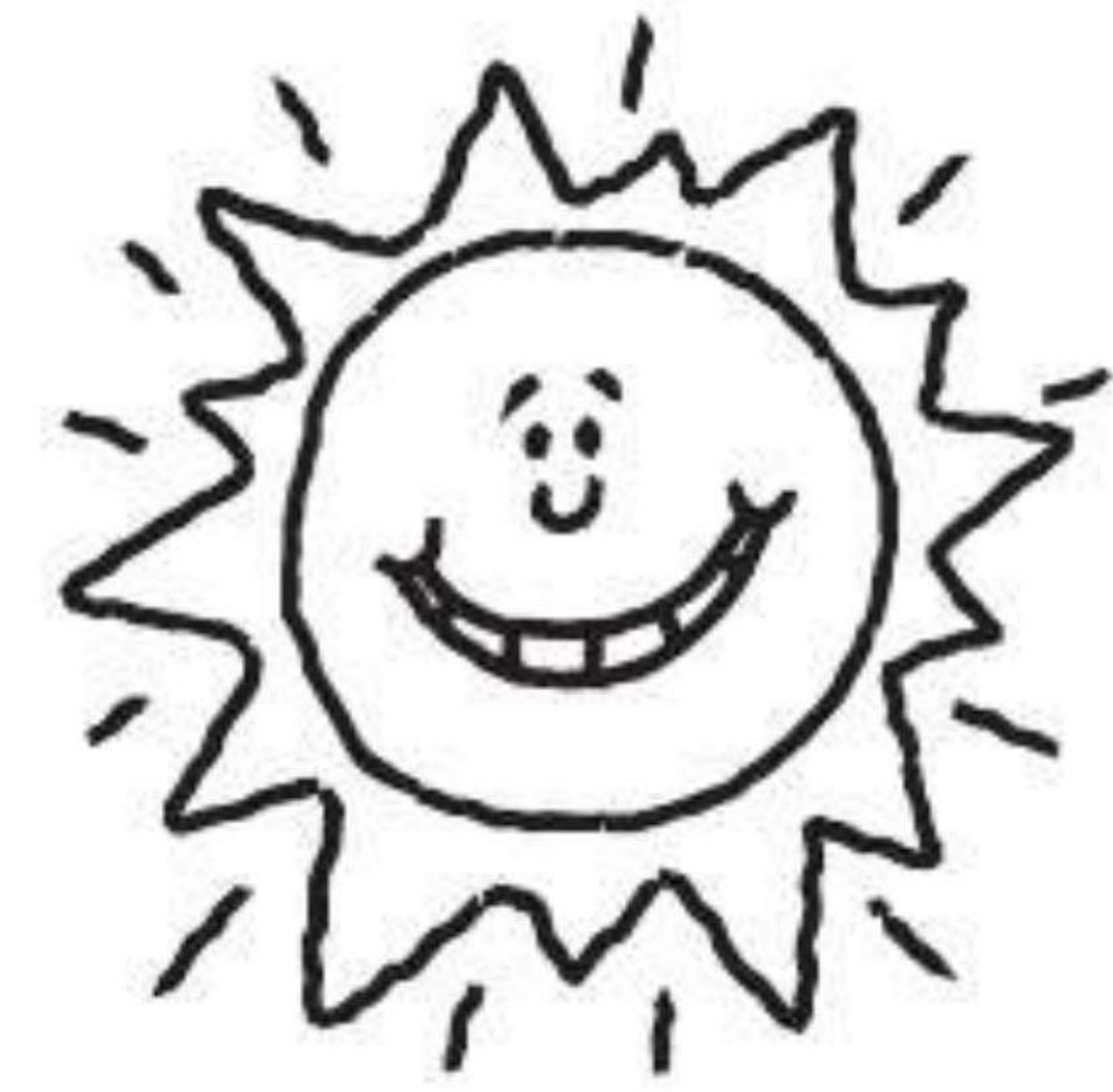
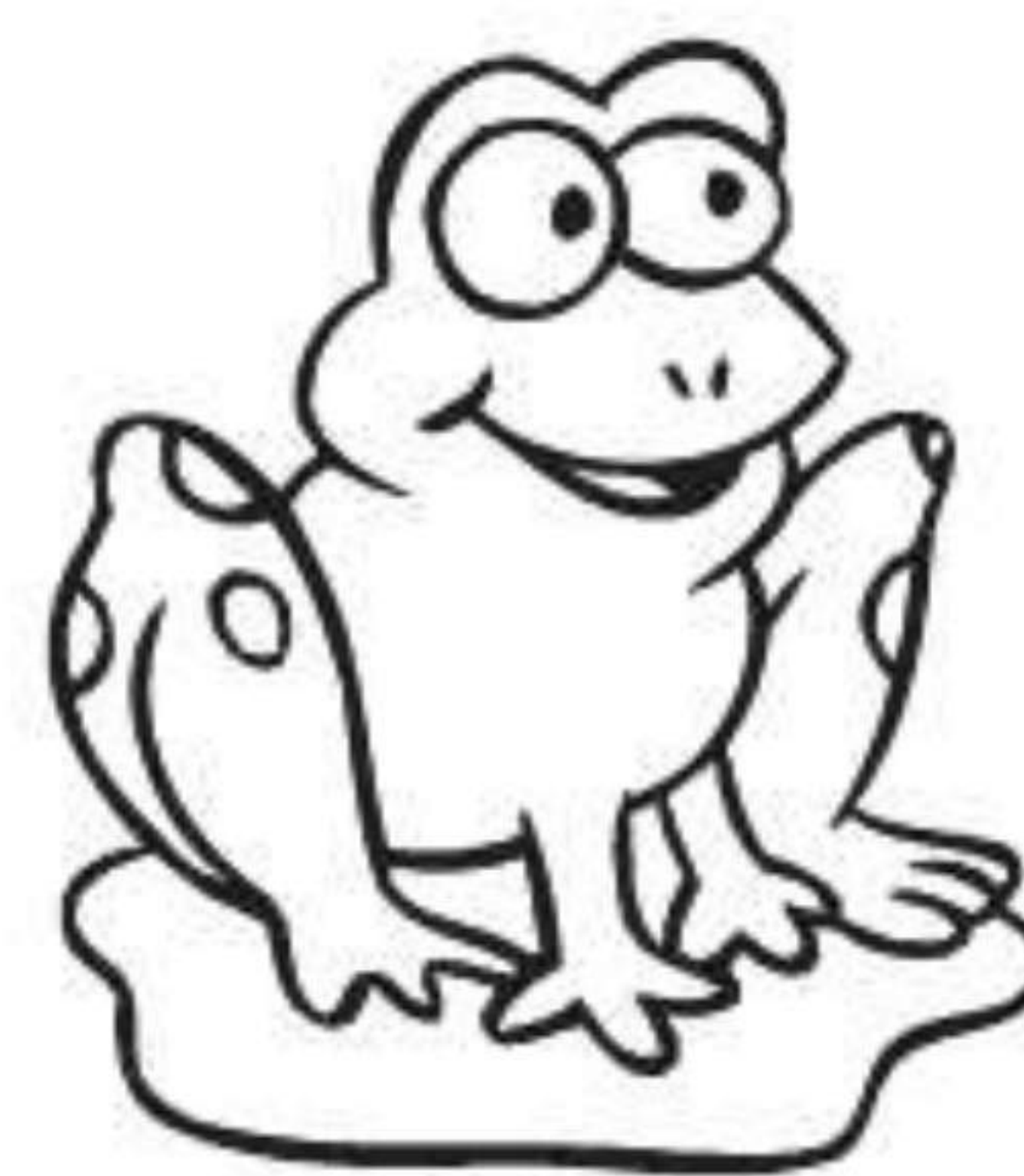
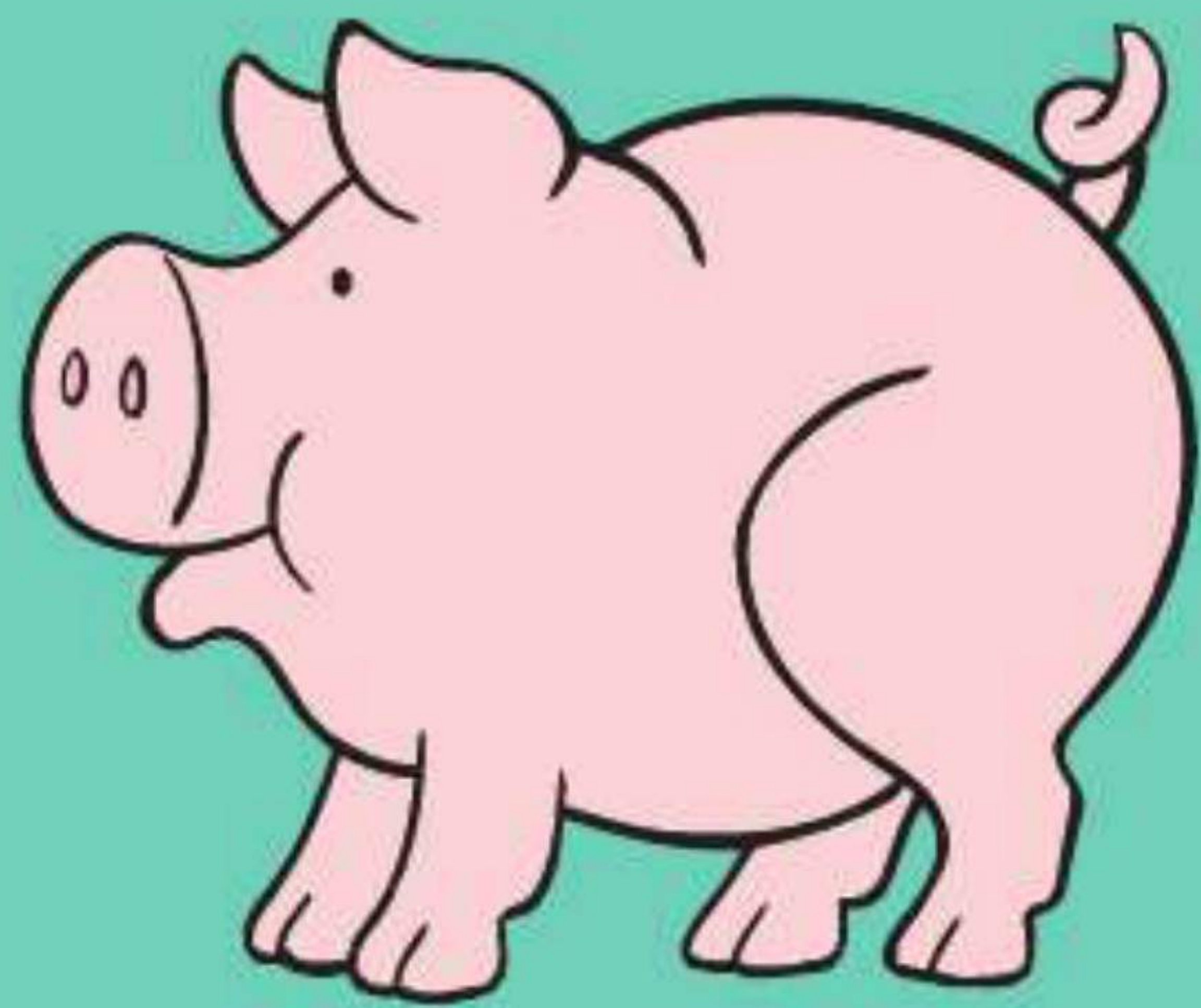





Directions: Say the name of the picture in each box. Color the pictures in each row that end with the same sound.



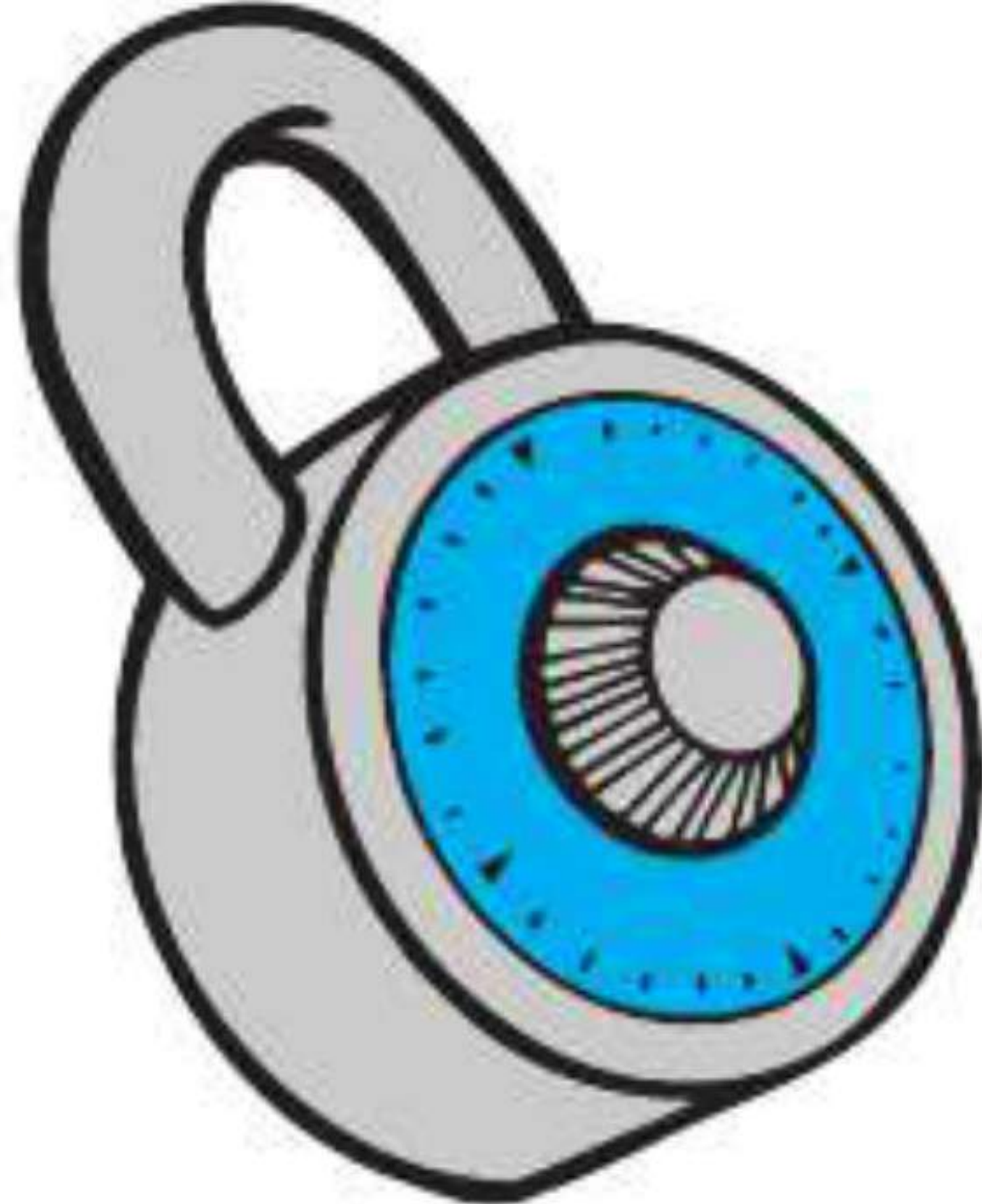
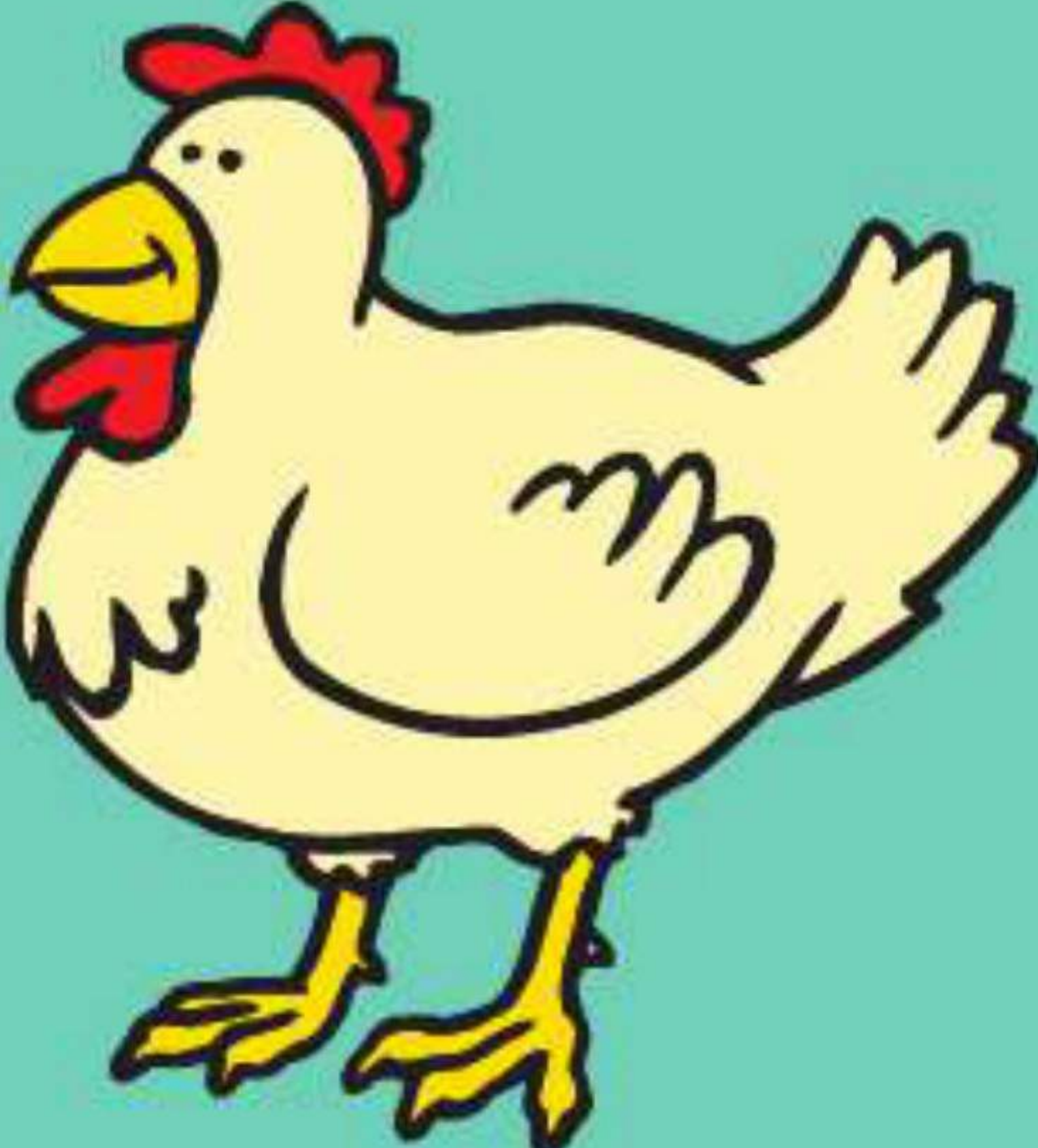

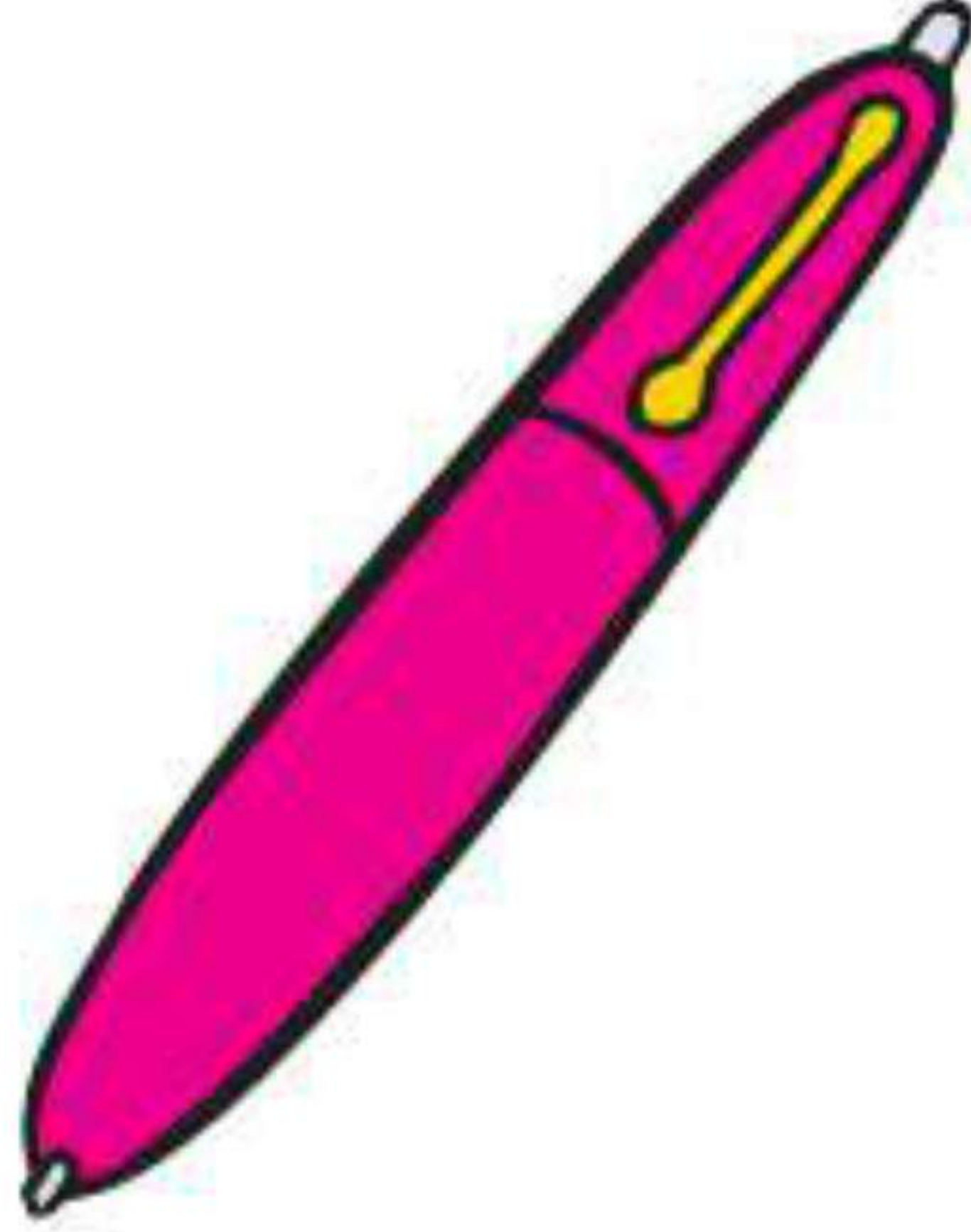
Ending Consonant Sounds

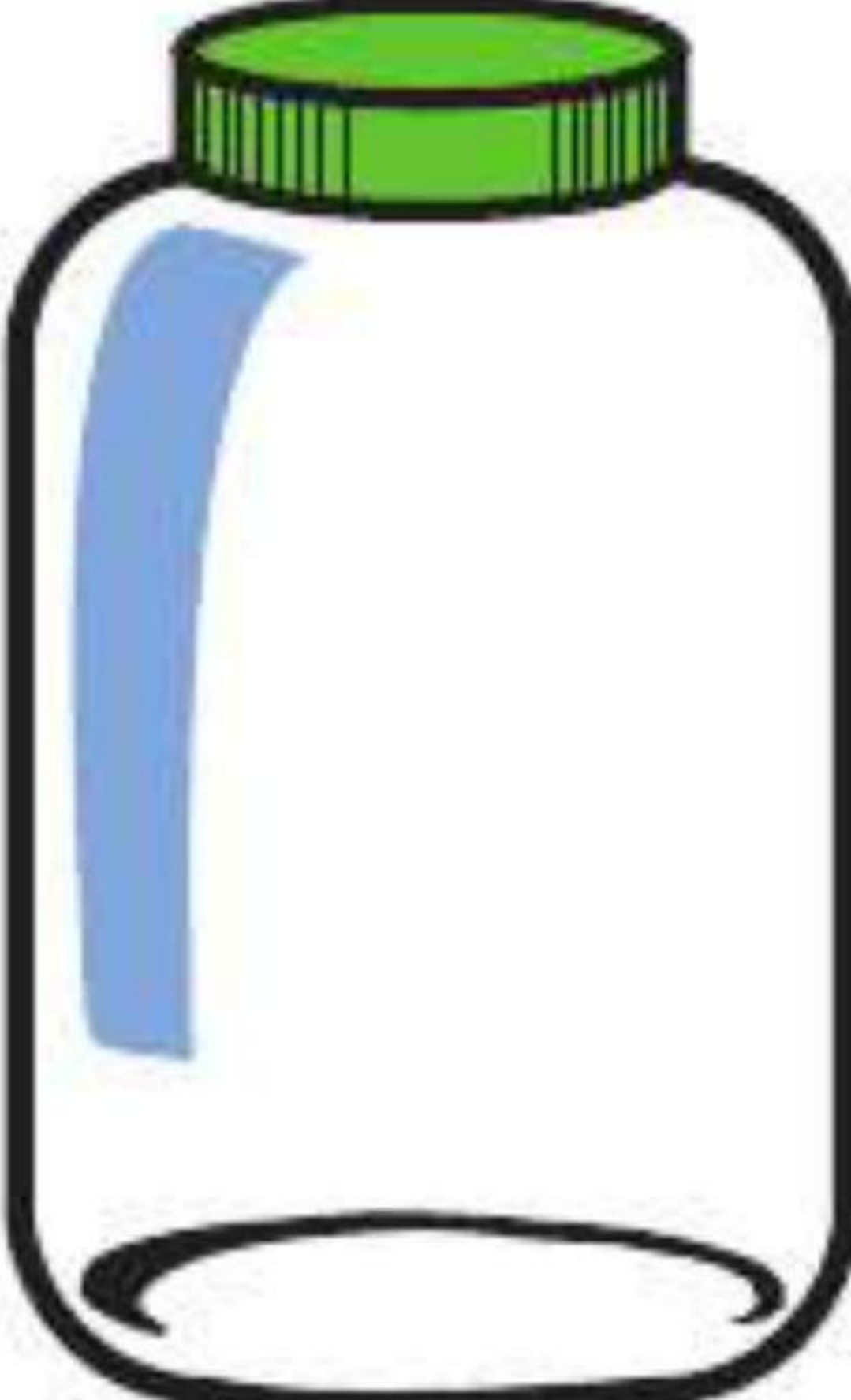
Directions: Say the name of the picture in each box. Circle the pictures in that row that have the same ending sound.



Ending Consonant Sounds

Directions: Say the name of the picture in each box. Circle the ending sound for each picture.



d t



b p

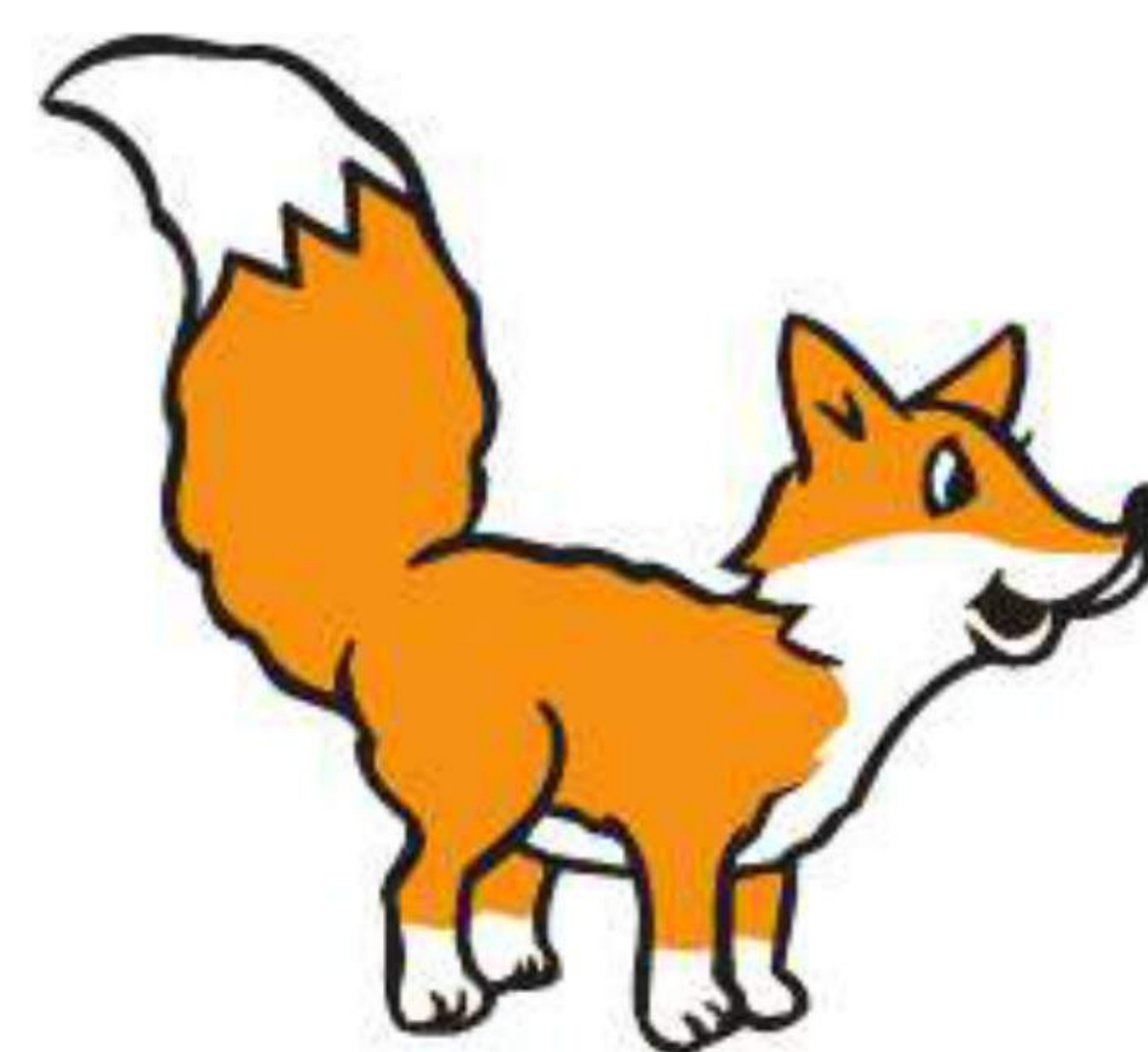

x s



n m



g f



s b



r t



d r

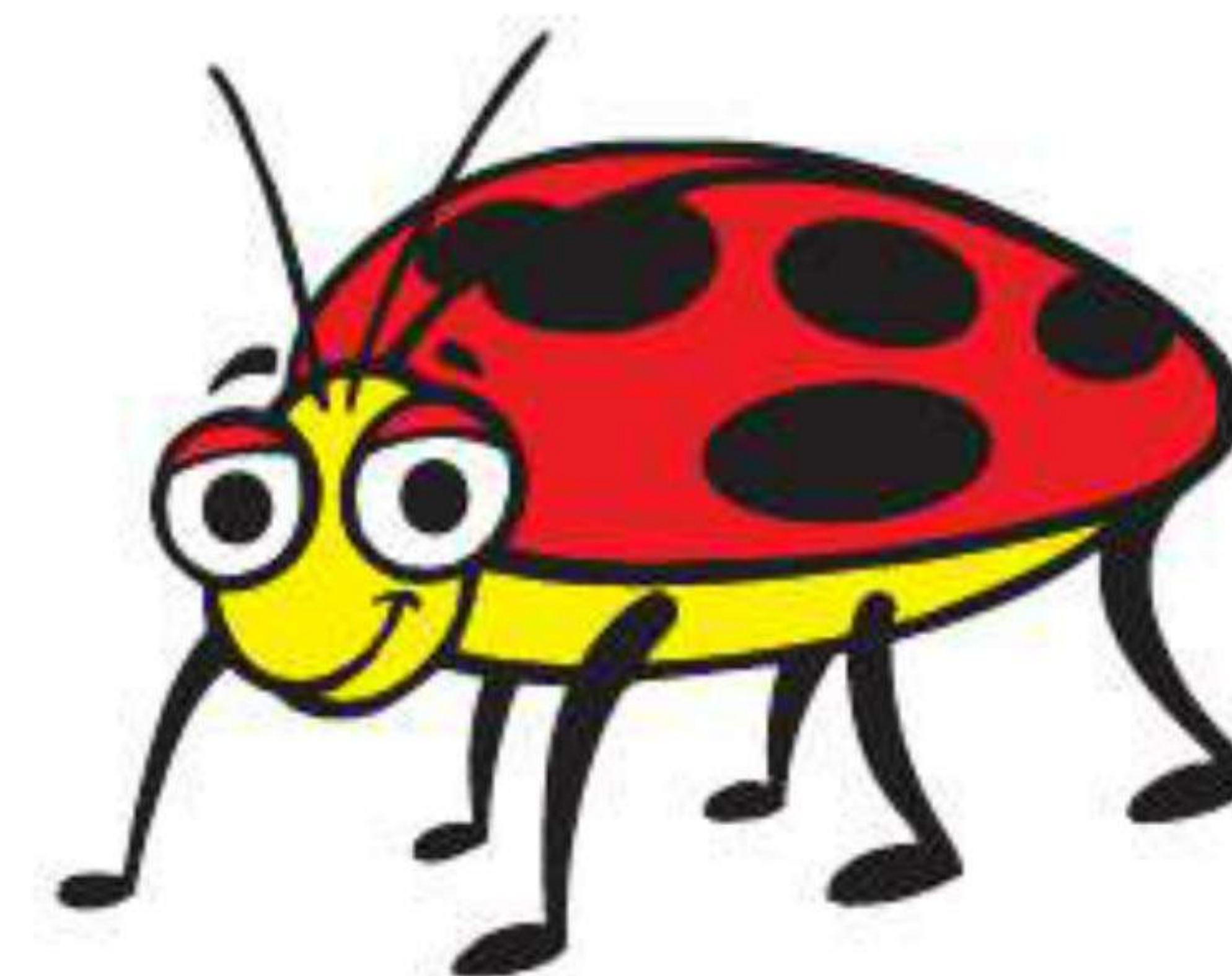

g v



Ending Consonant Sounds

Directions: Say the name of each picture. Write the letter to complete each word.

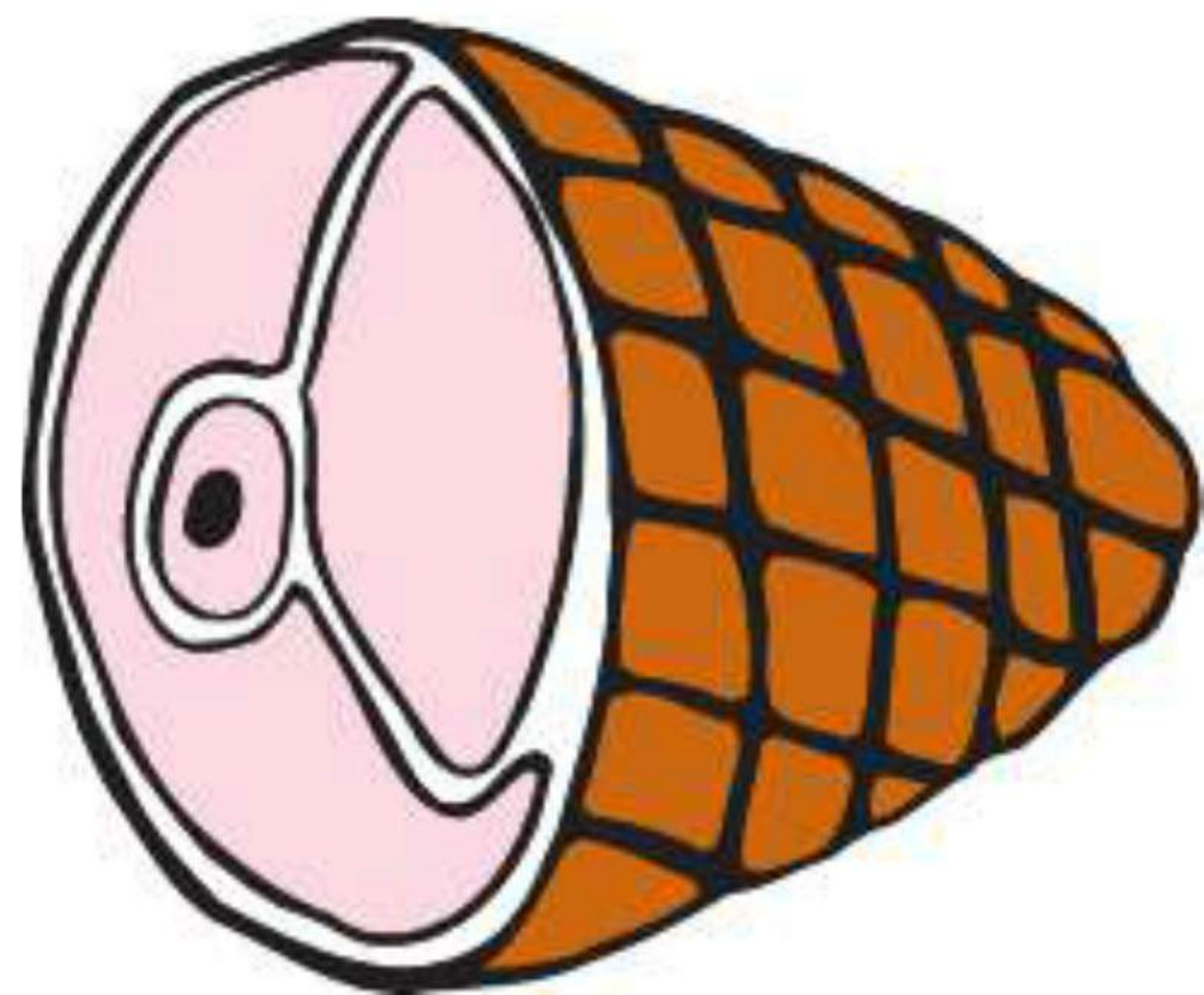

ha



ja

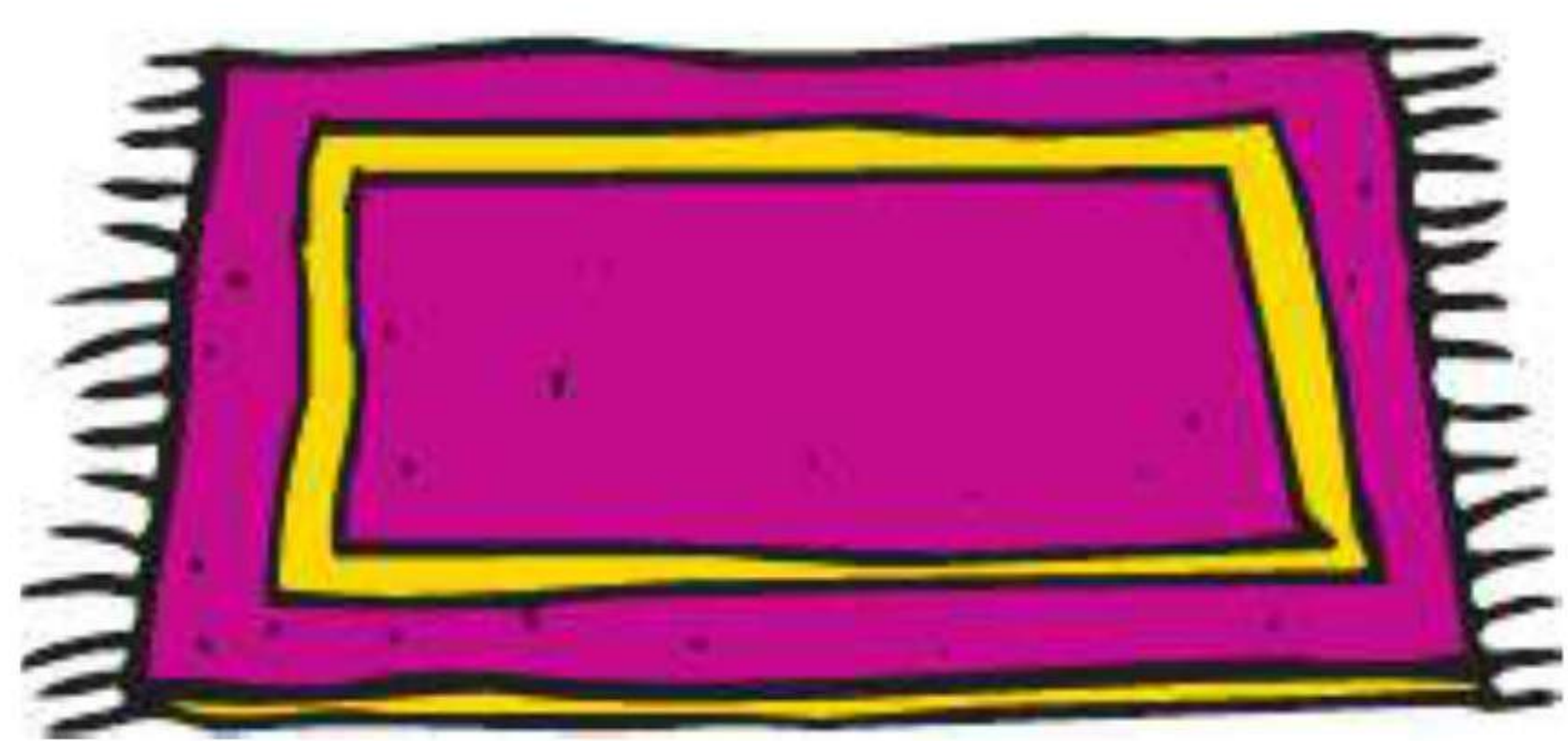

ru

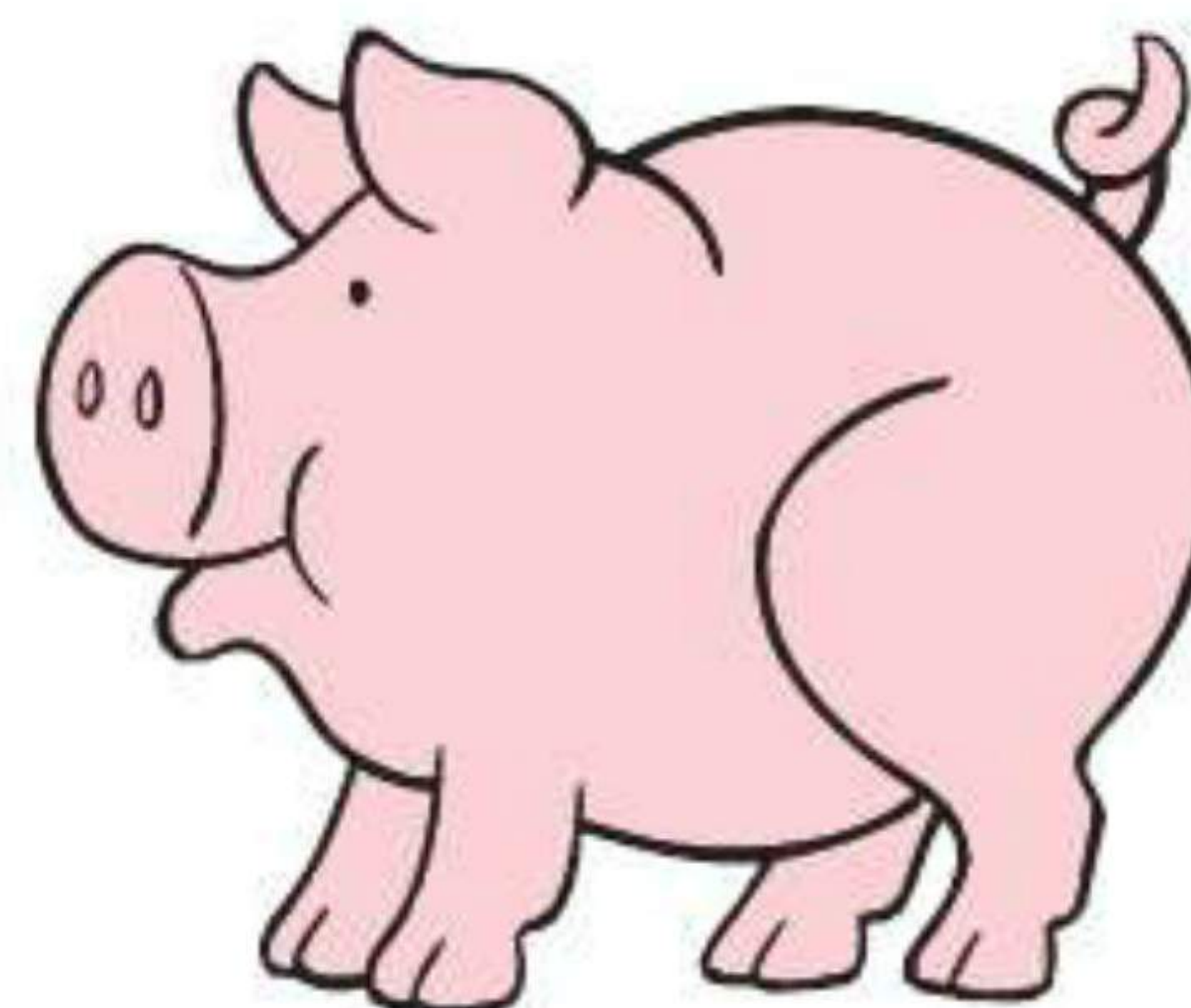

pi



da

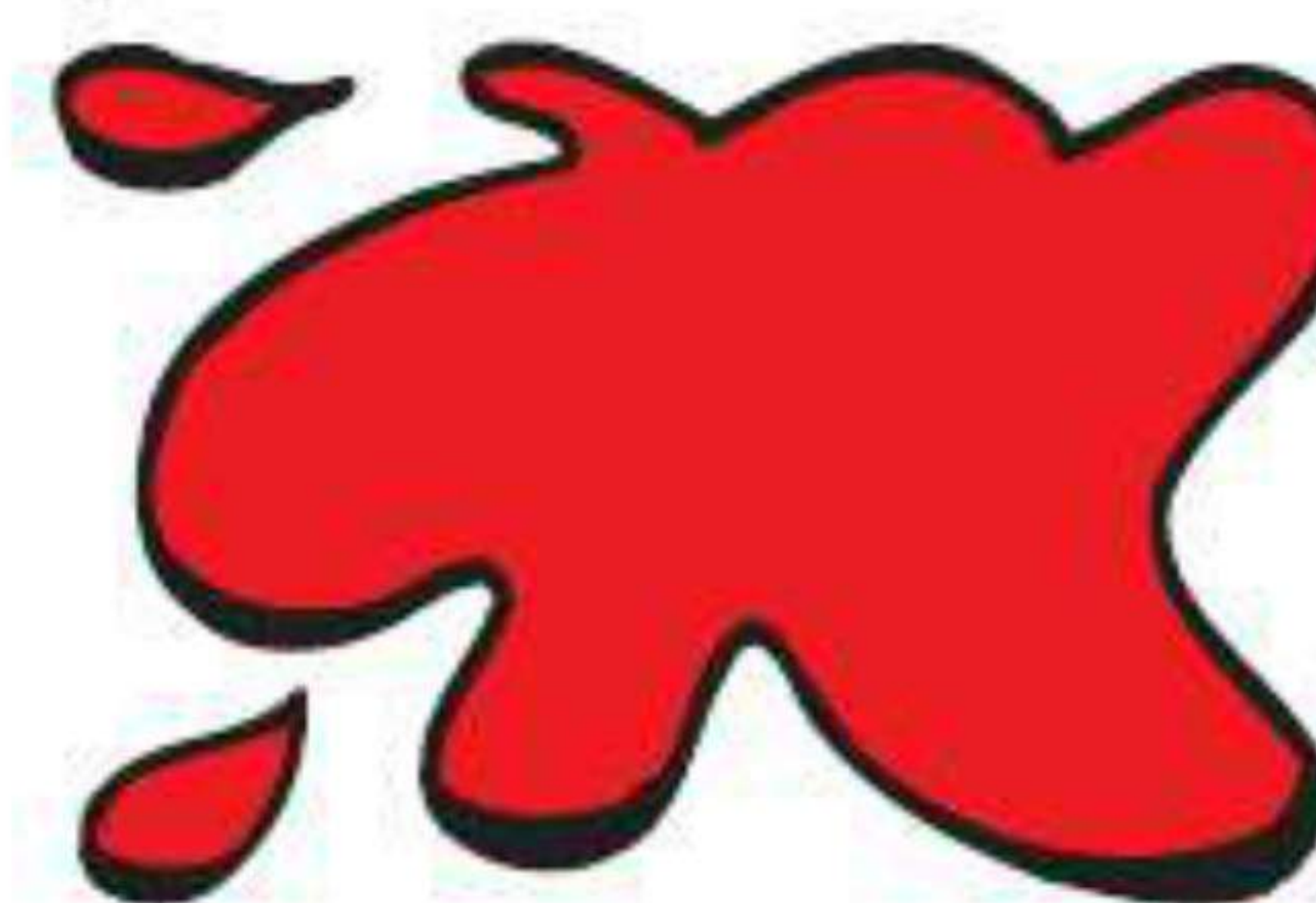

re



Vowel Sounds

Directions: Say the name of the picture in each box. Circle the pictures in each row that have the same vowel sound.

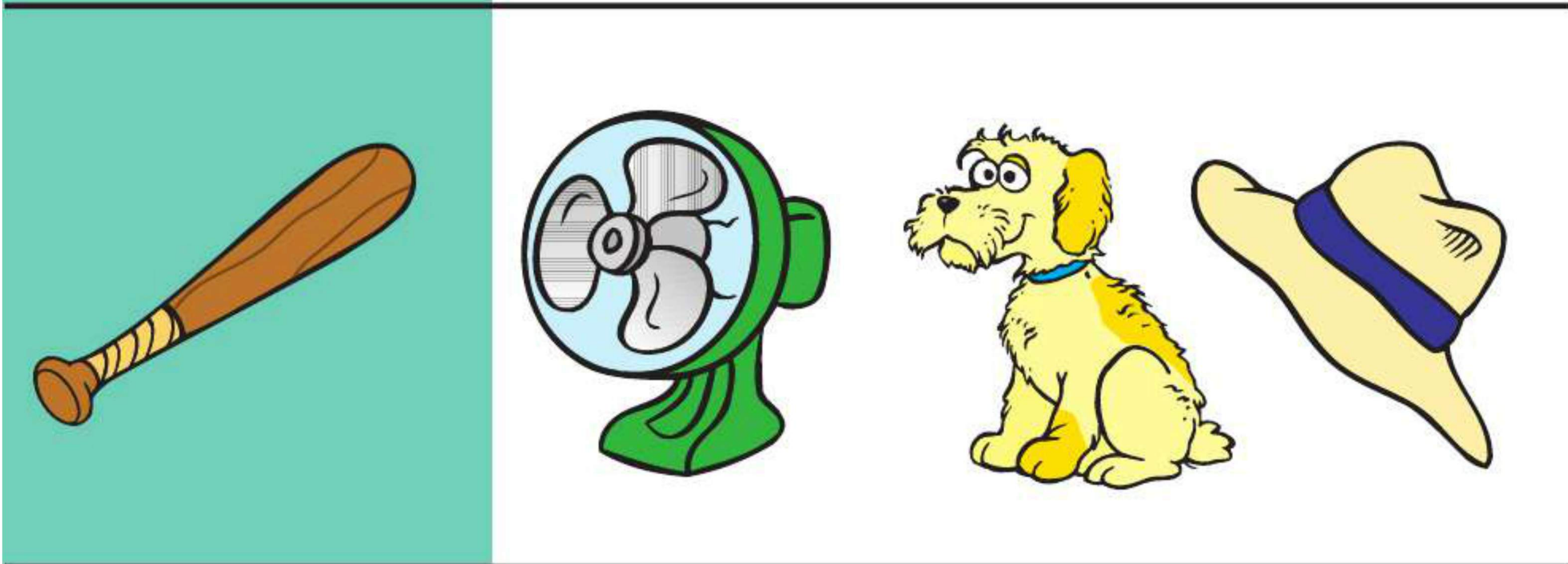
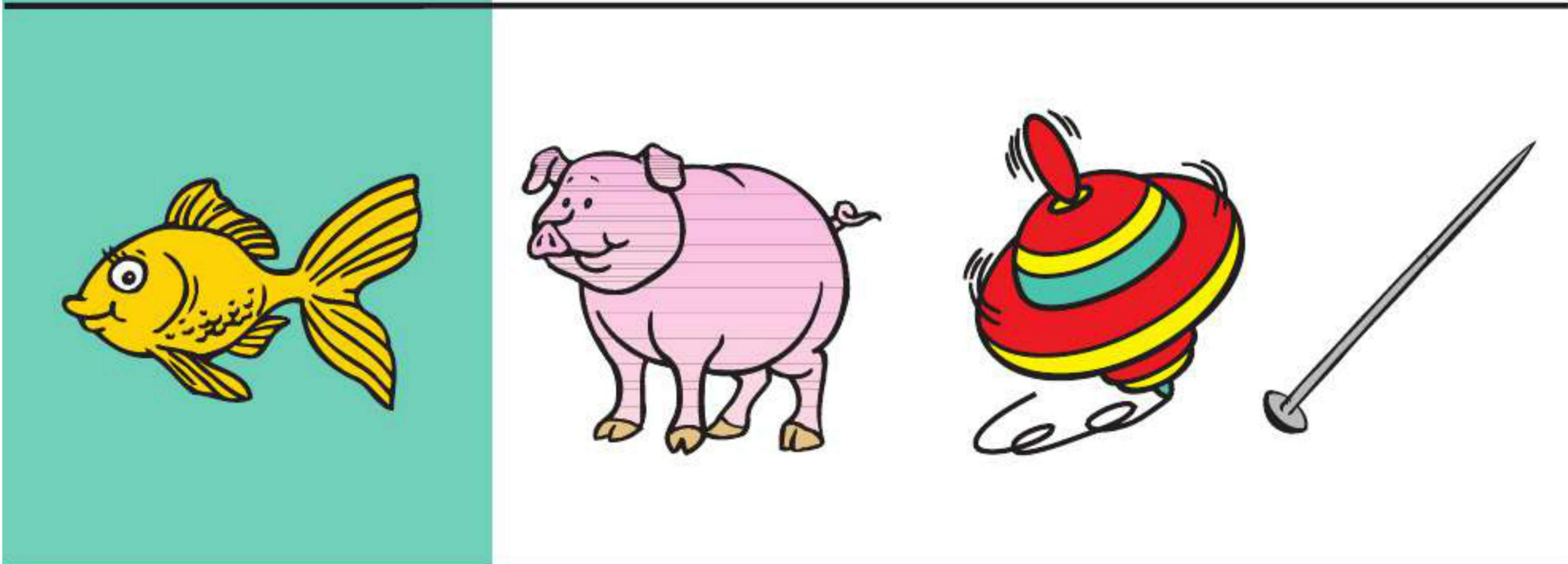
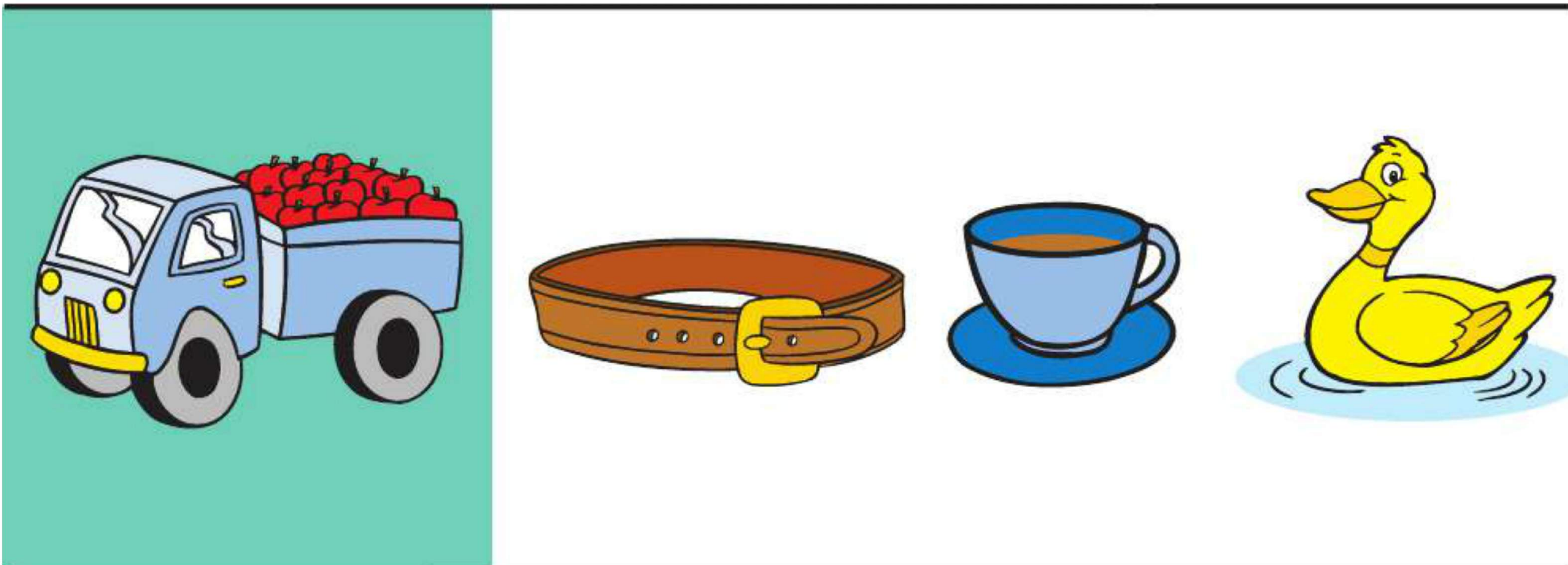

Name _____



Vowel Sounds

Directions: Say the name of each picture. Draw a line to the letter that makes the same vowel sound.



a

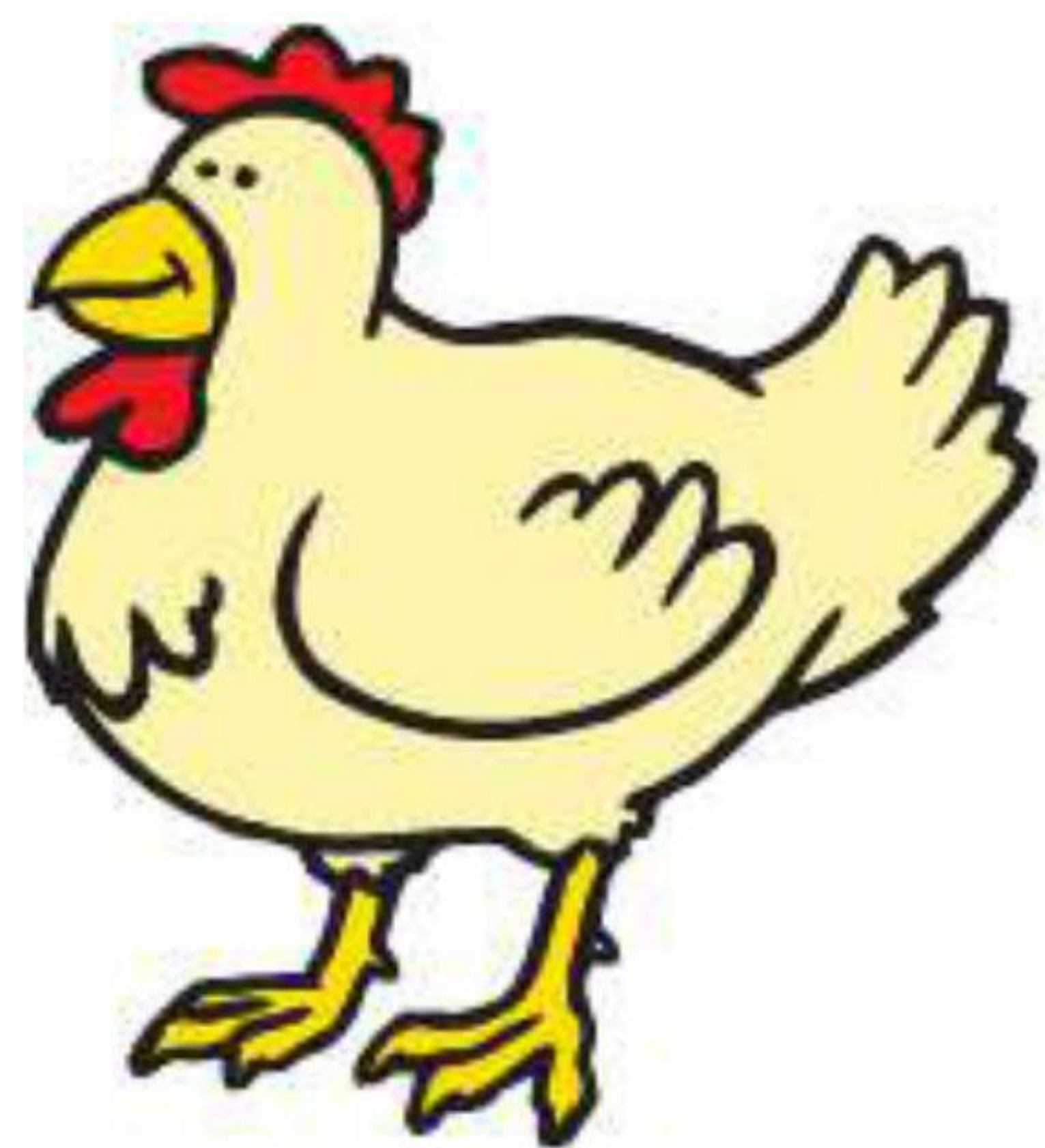

e



i

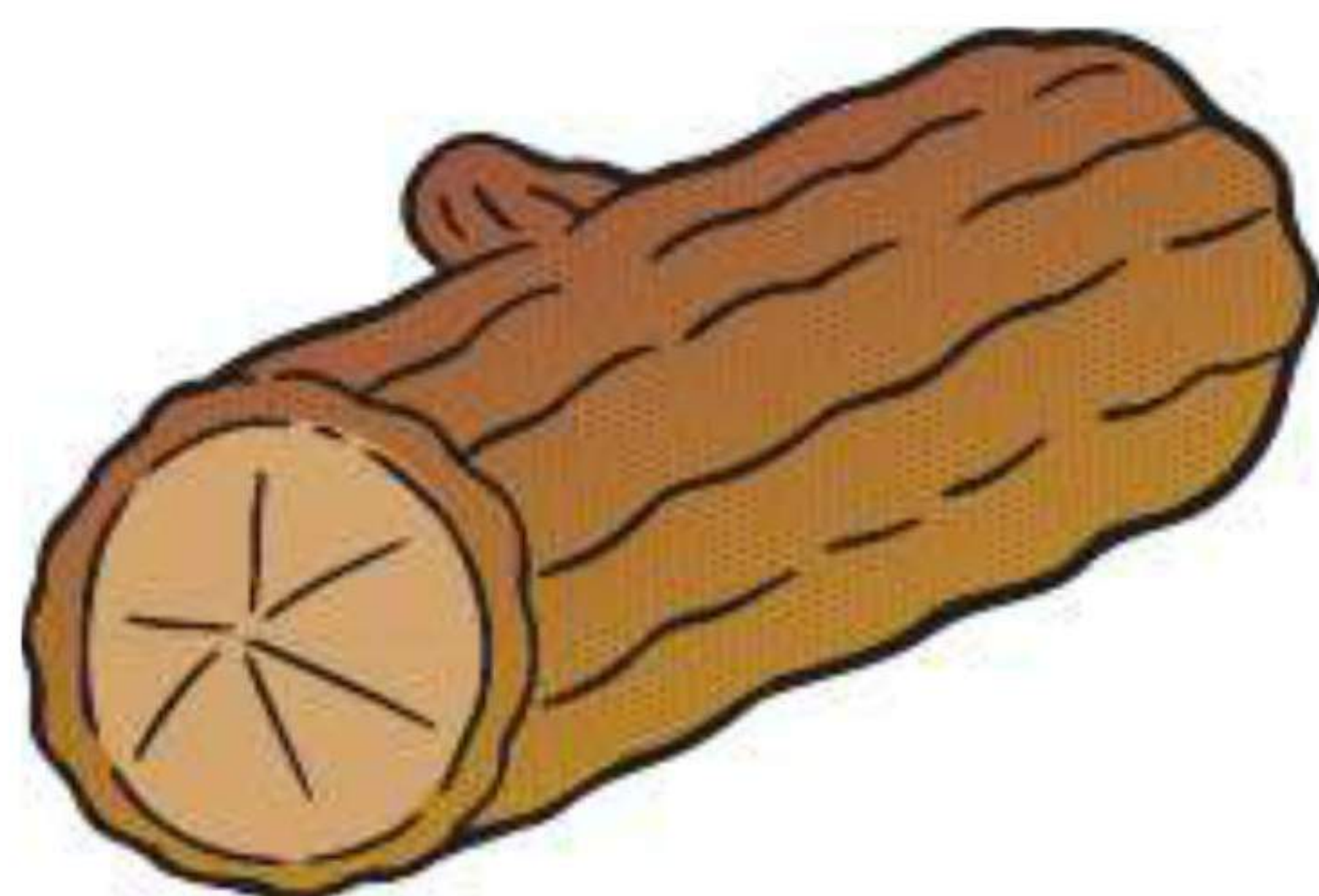

o

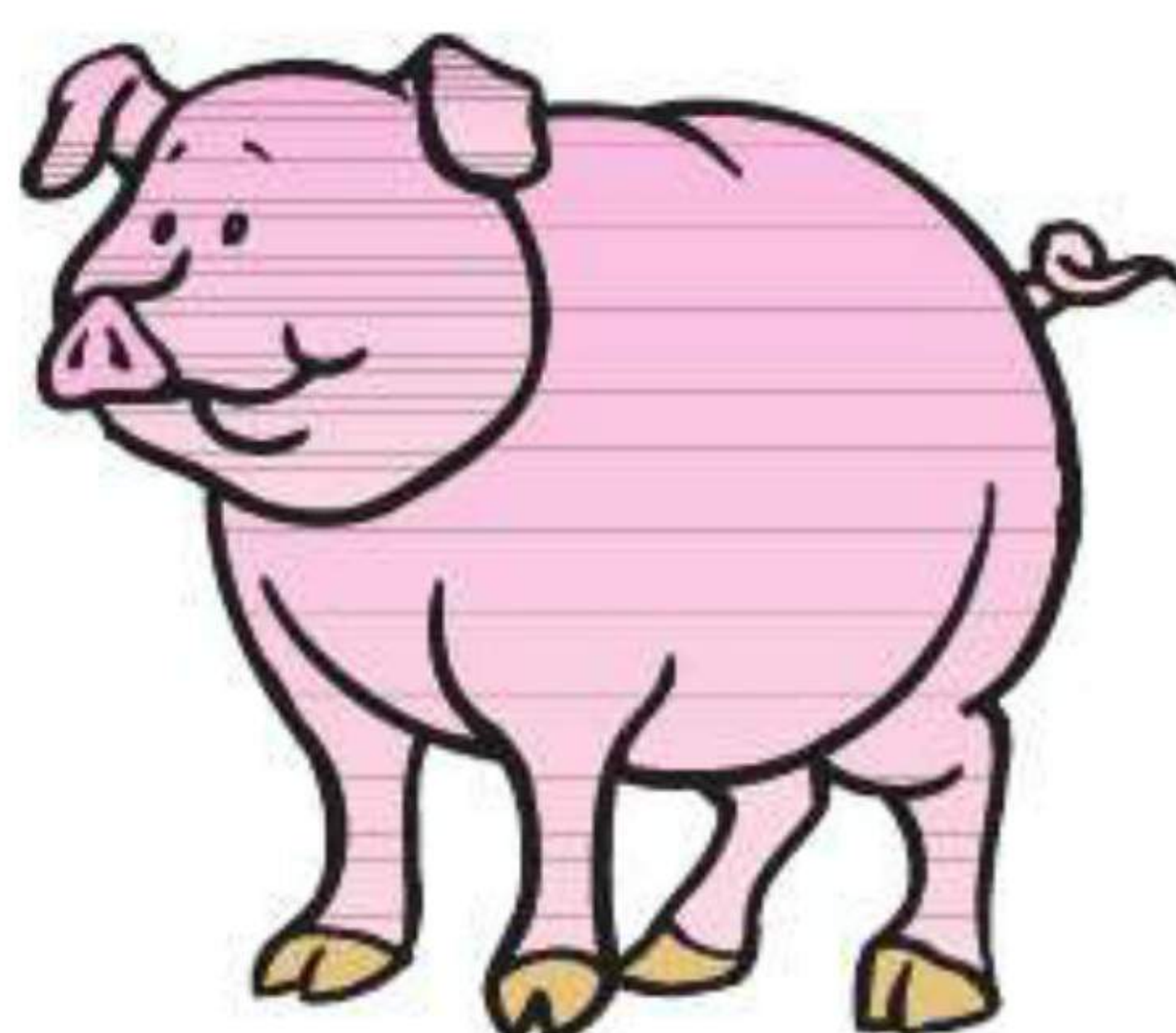

u



Vowel Sounds

Directions: Say the name of each picture. Draw a line to the letter that makes the same vowel sound.

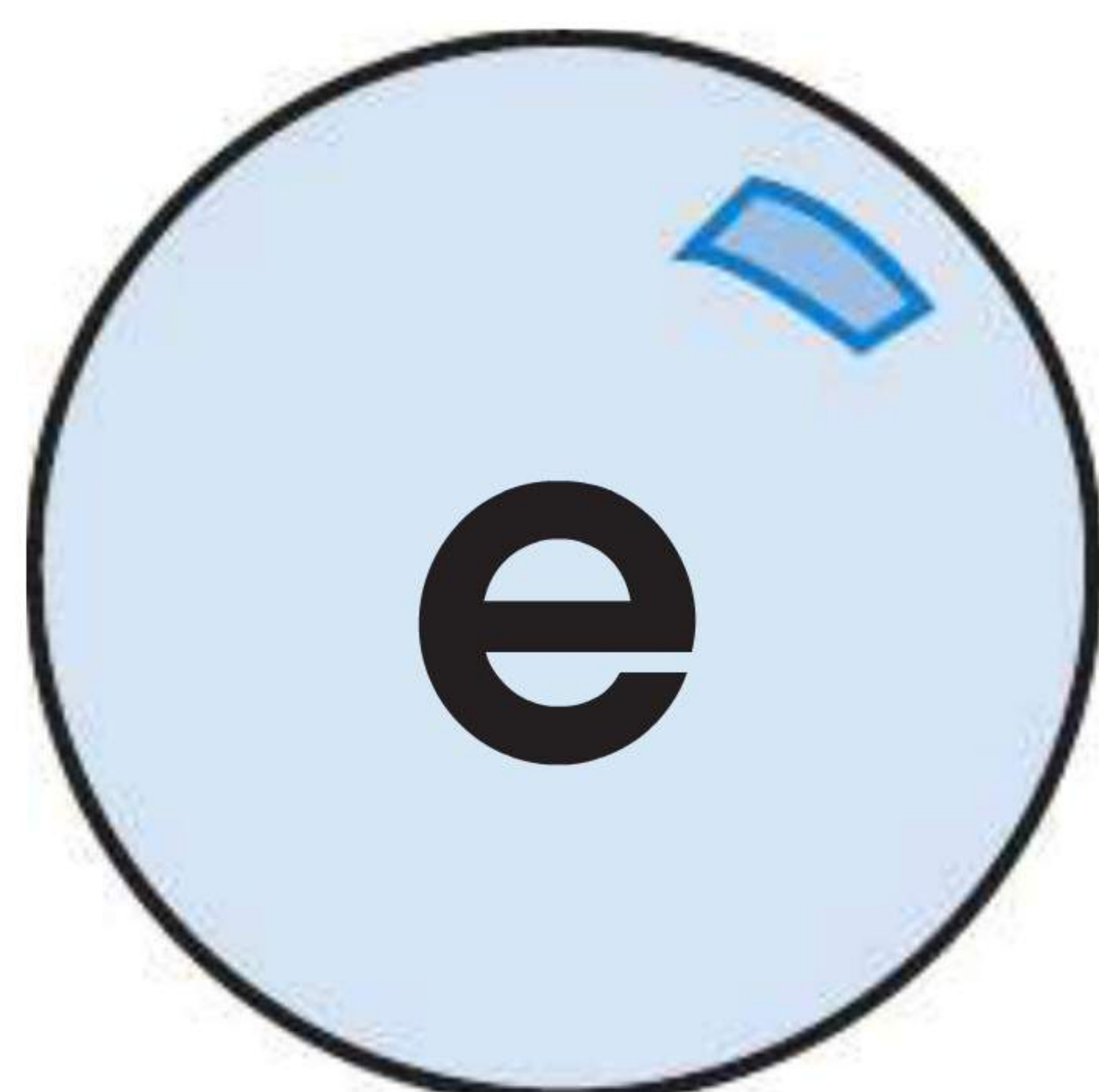
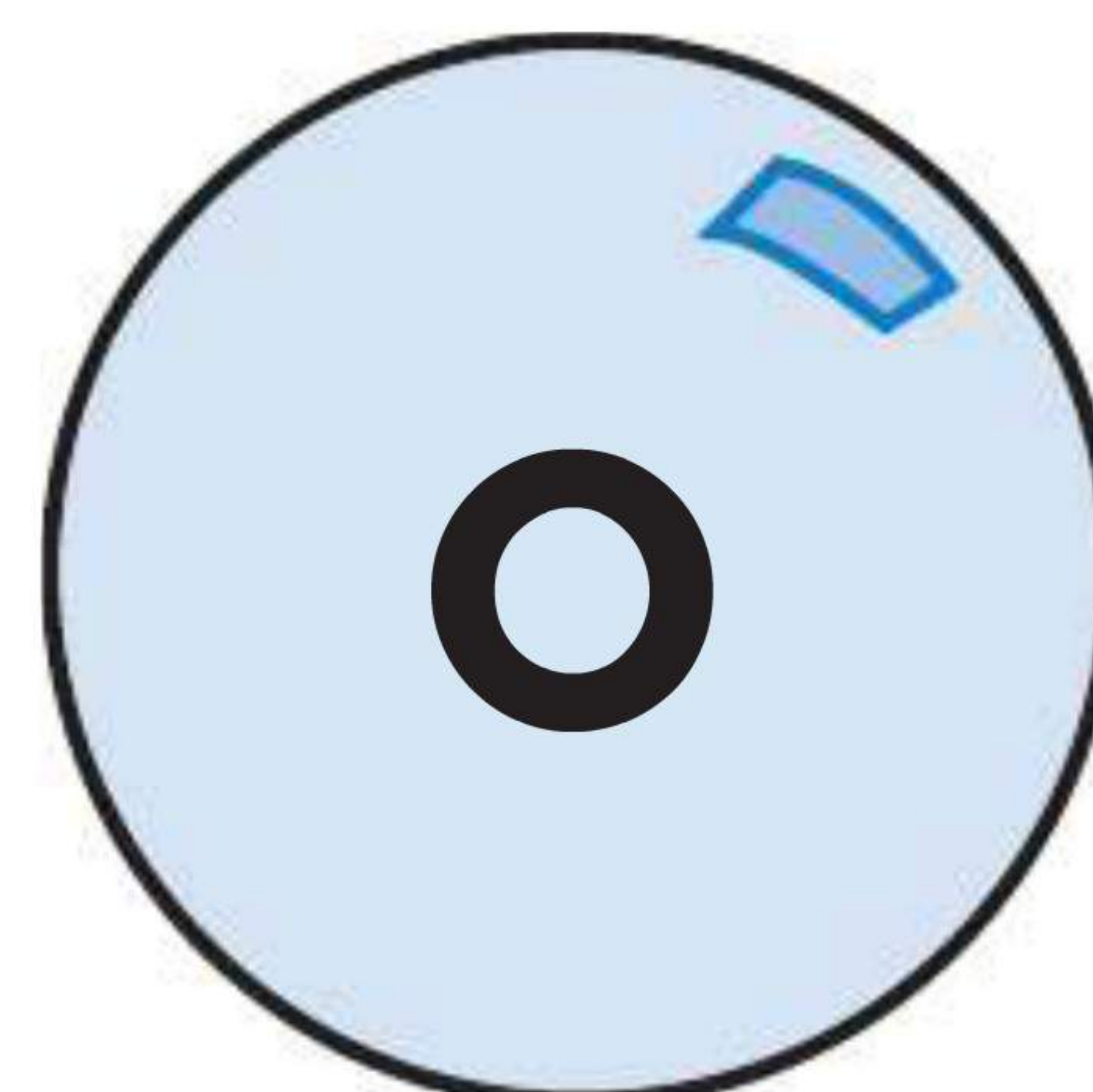
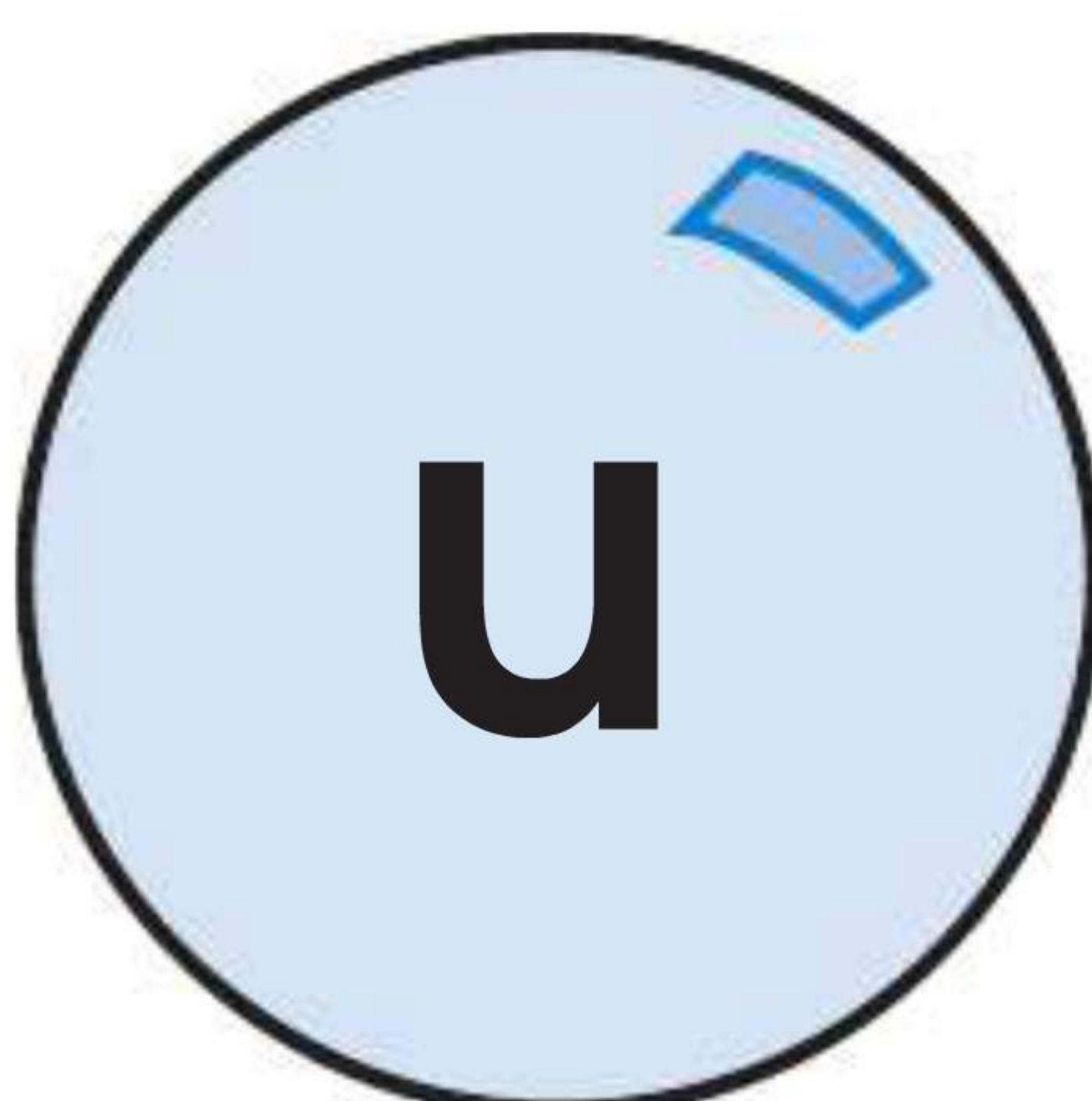
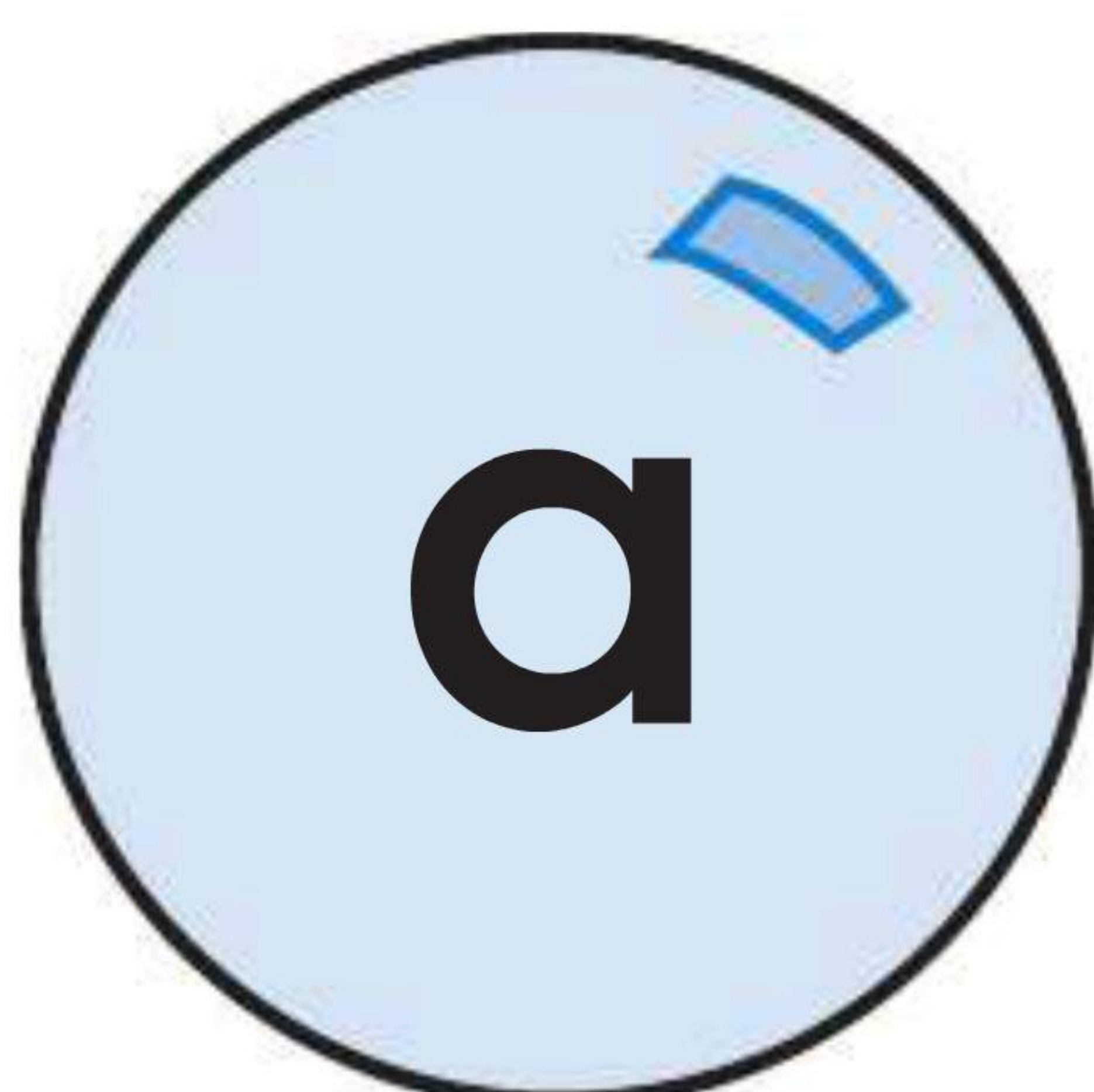
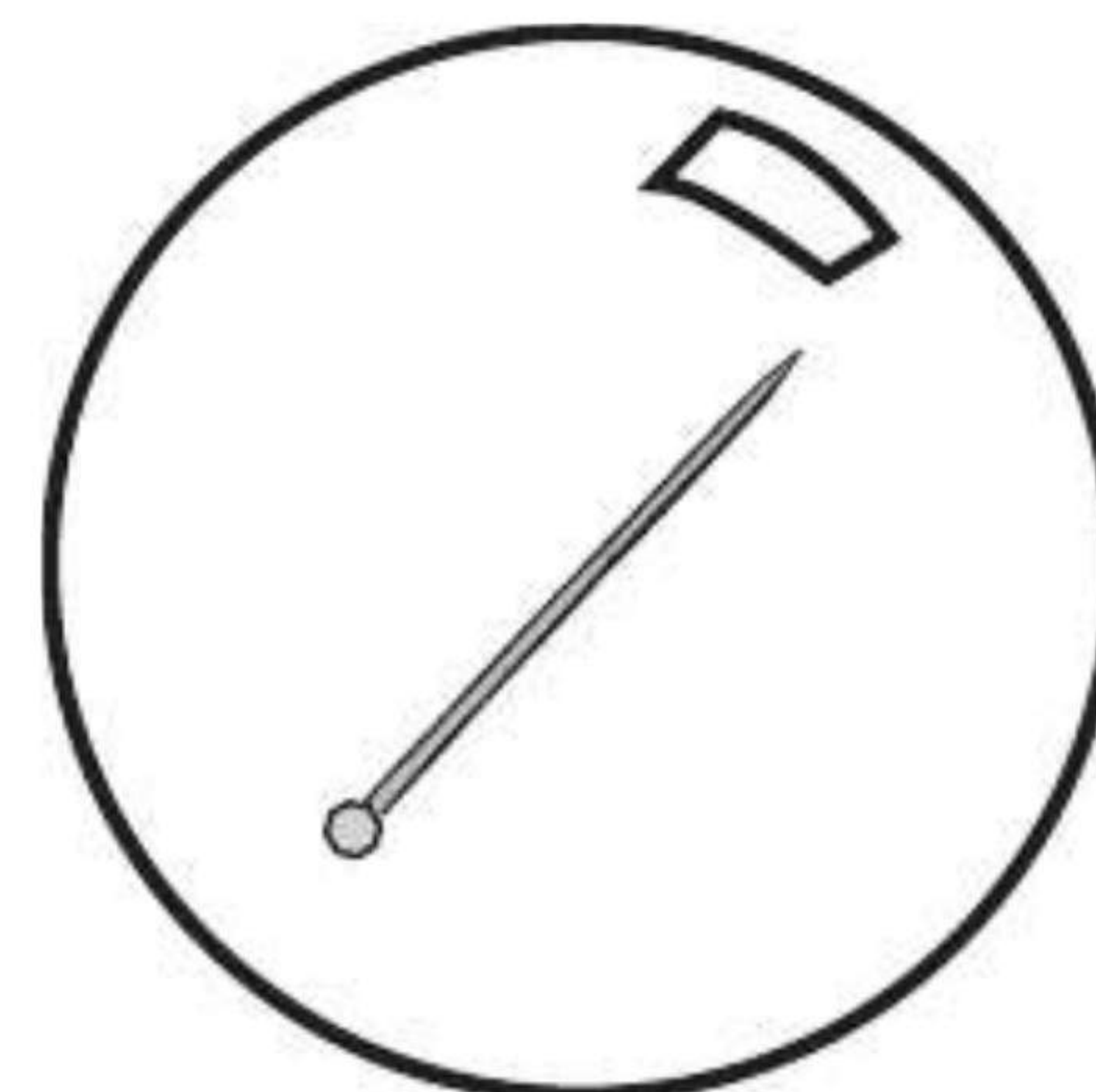
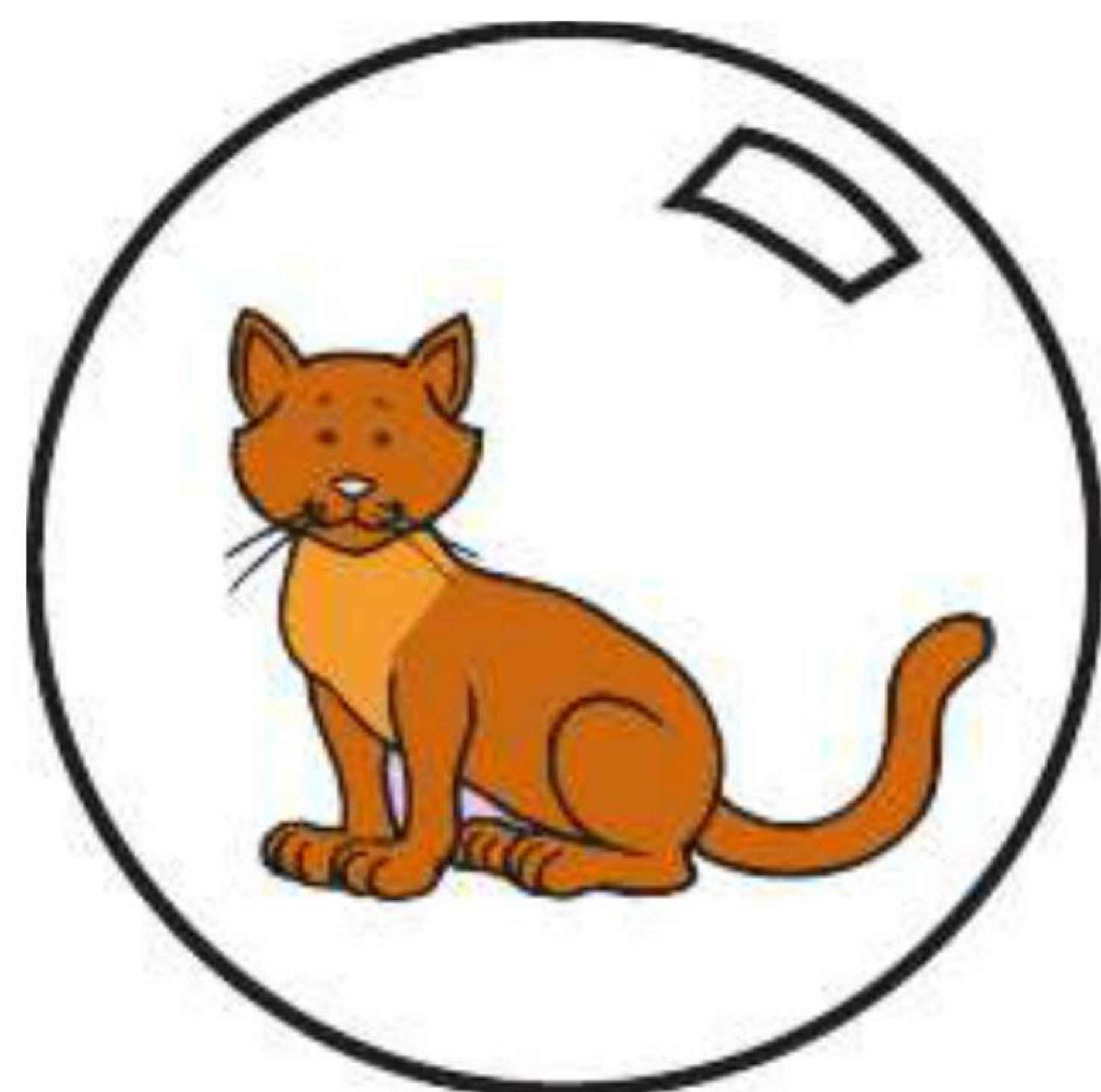



Short Vowels: Aa, Ii

Directions: Say each picture name. Circle the vowel sound you hear.



a i

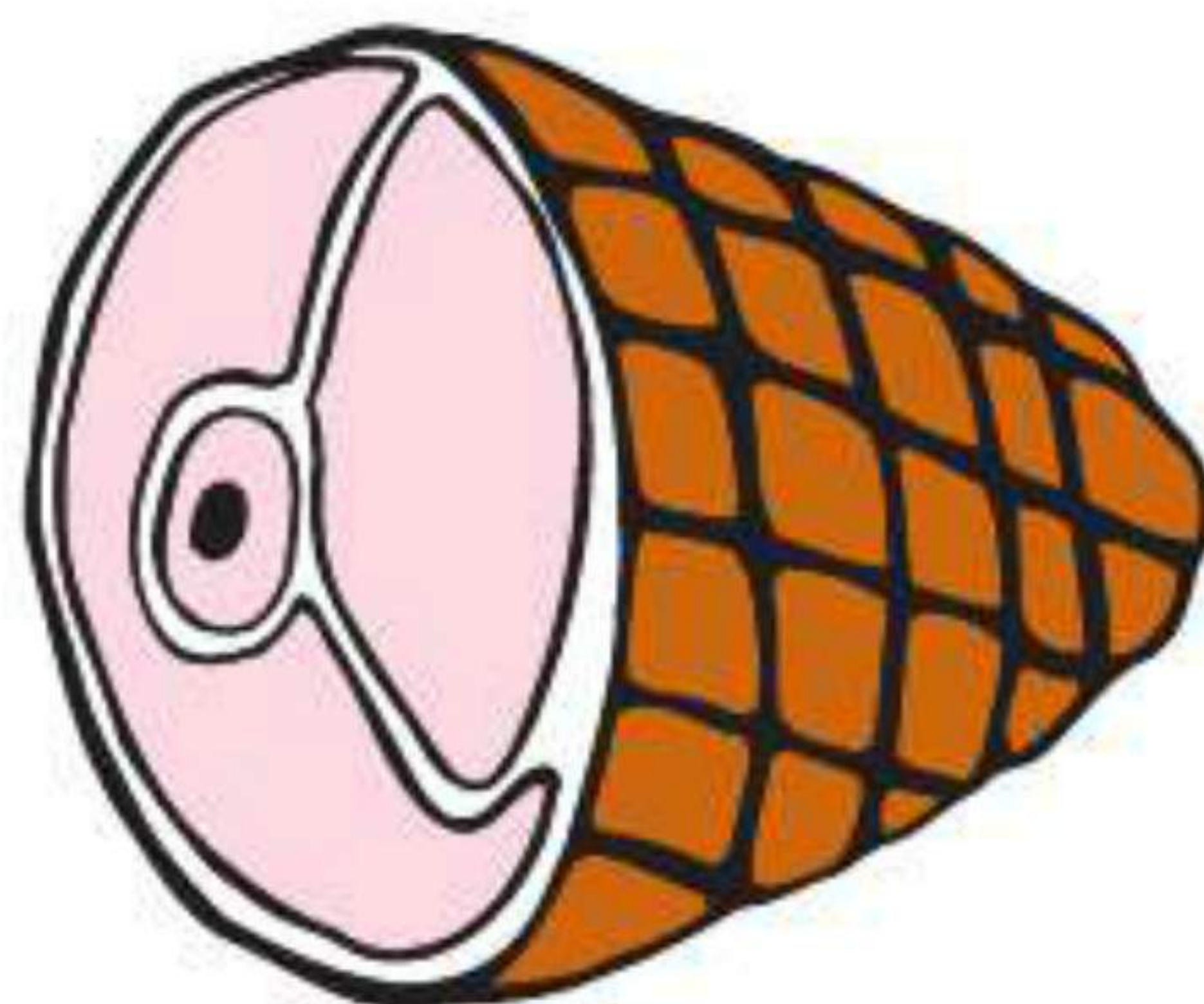

a i

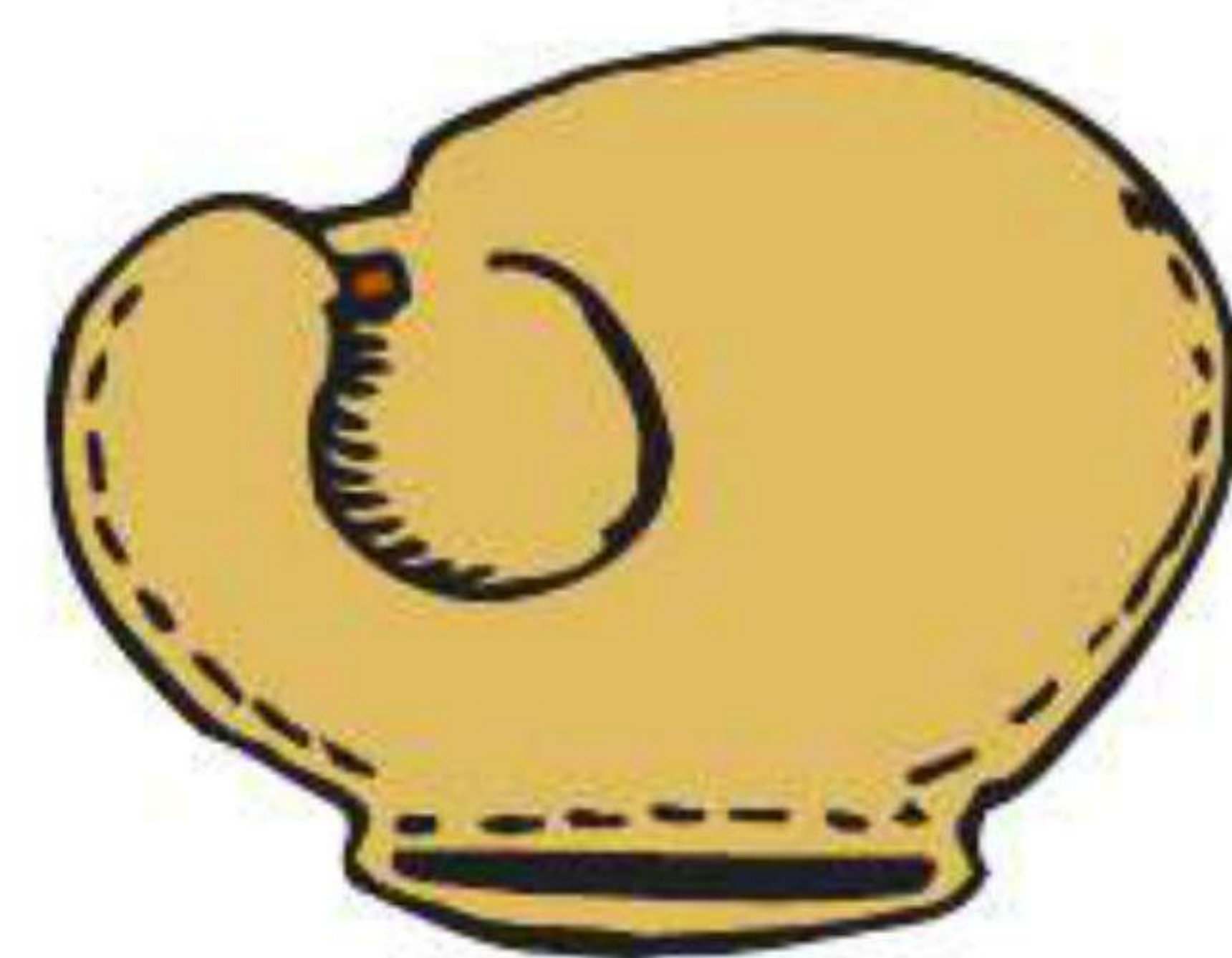

a i



a i



a i

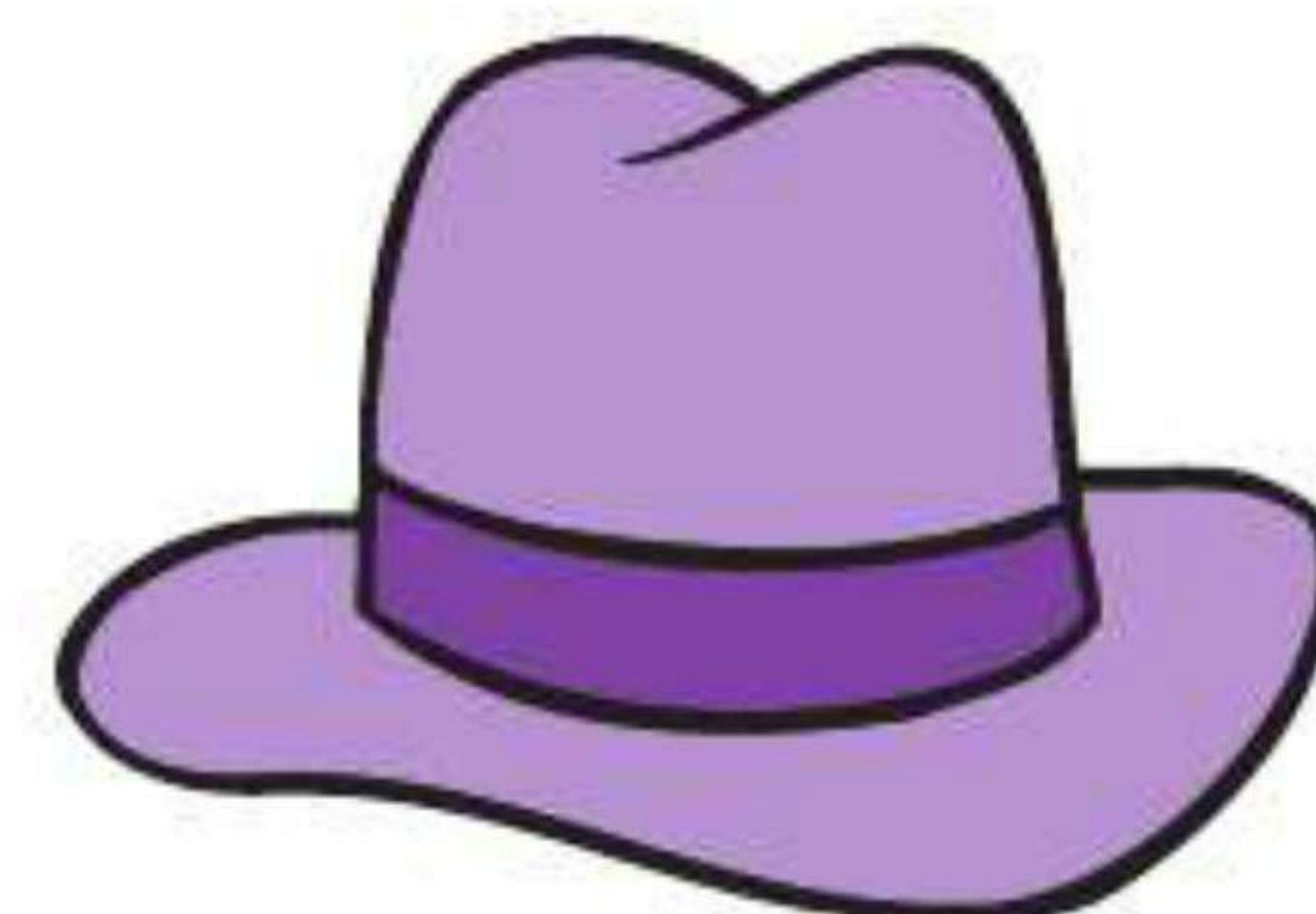

a i

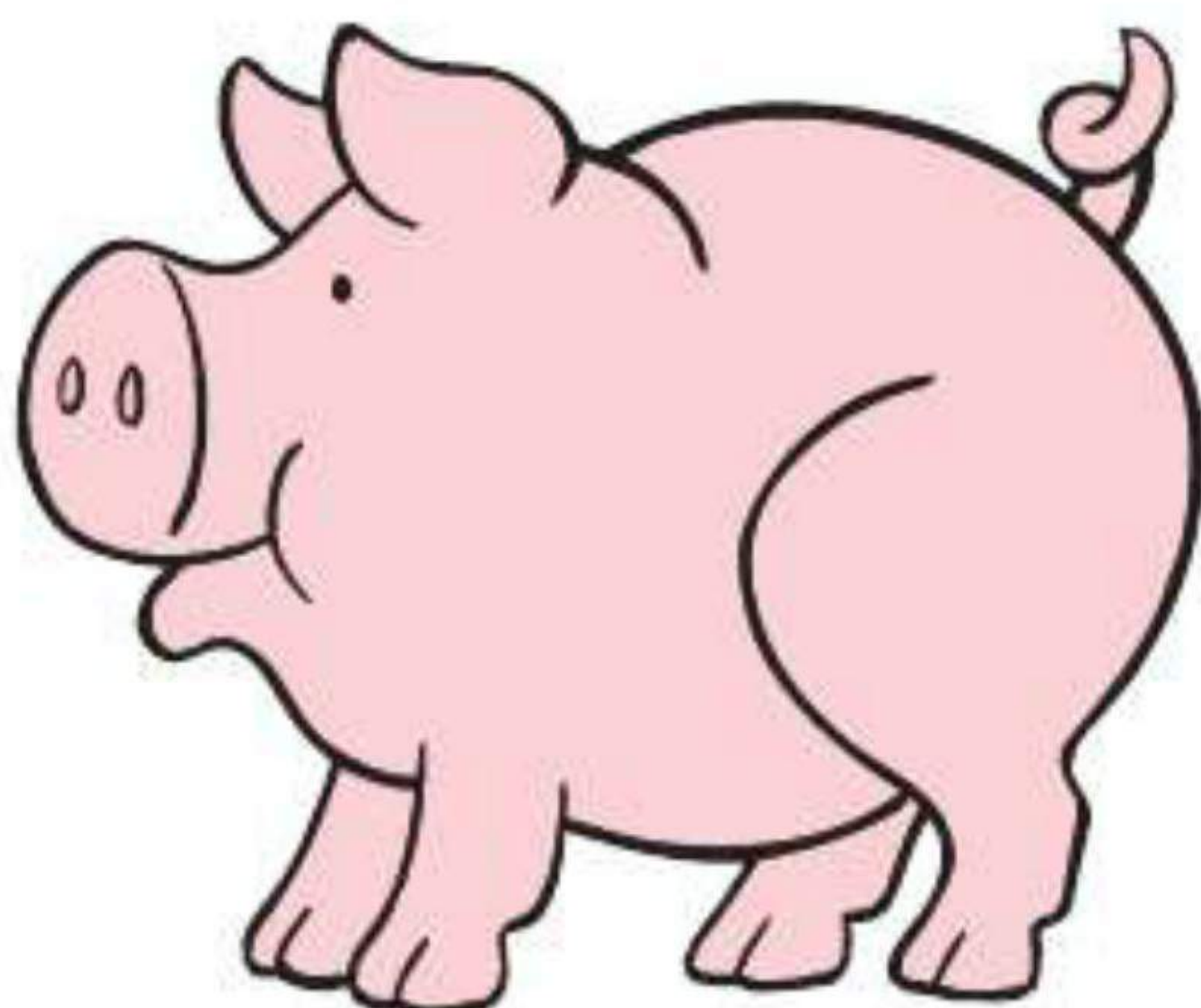

a i



a i



a i



Short Vowels: Oo, Uu, Ee

Directions: Say each picture name. Circle the vowel sound you hear.



o u e



o u e



o u e



o u e



o u e



o u e



o u e



o u e

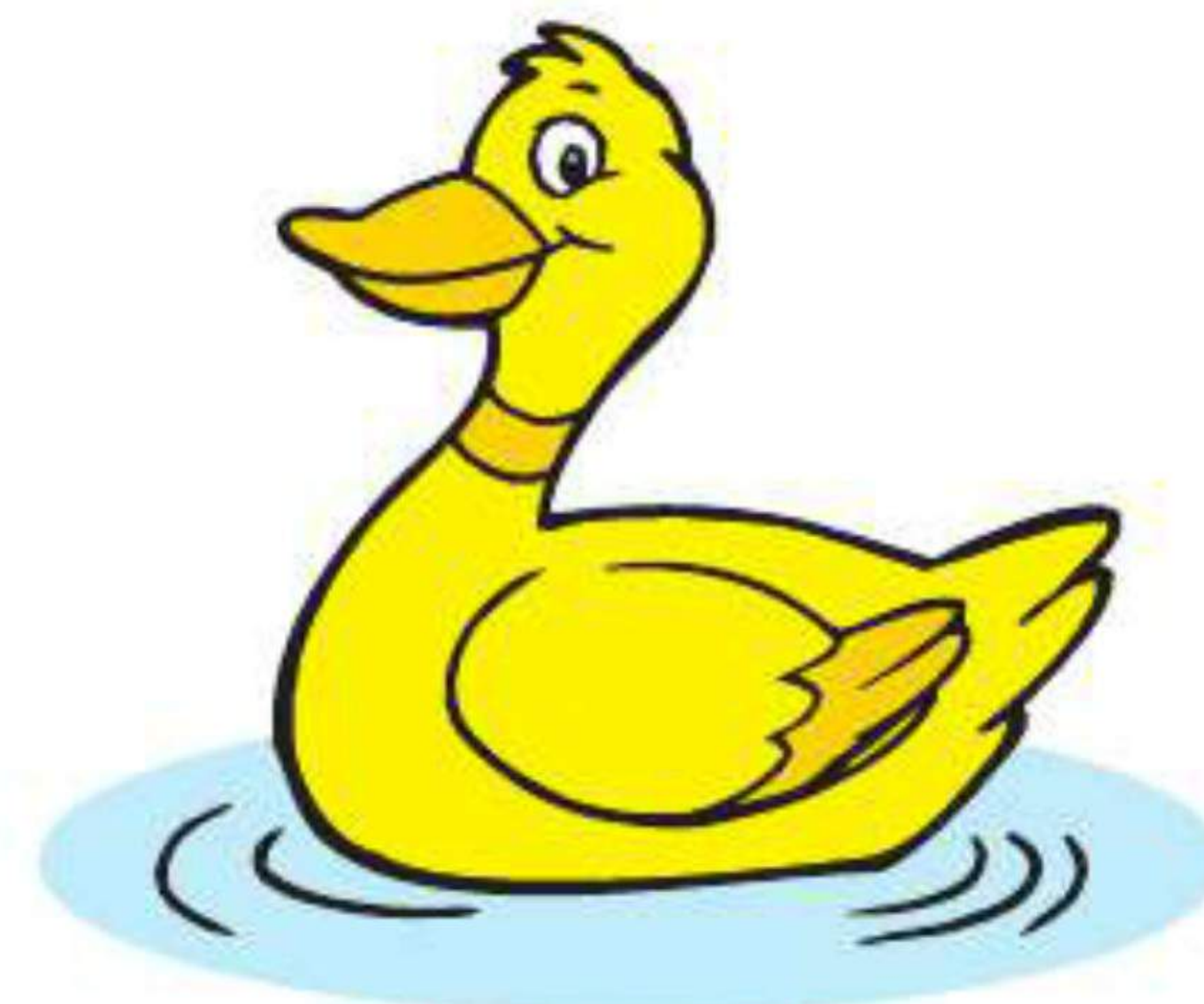

o u e



Review: Short Vowels

Directions: Say the name of each picture. Write the letter to complete each word.



c p



d g



b l

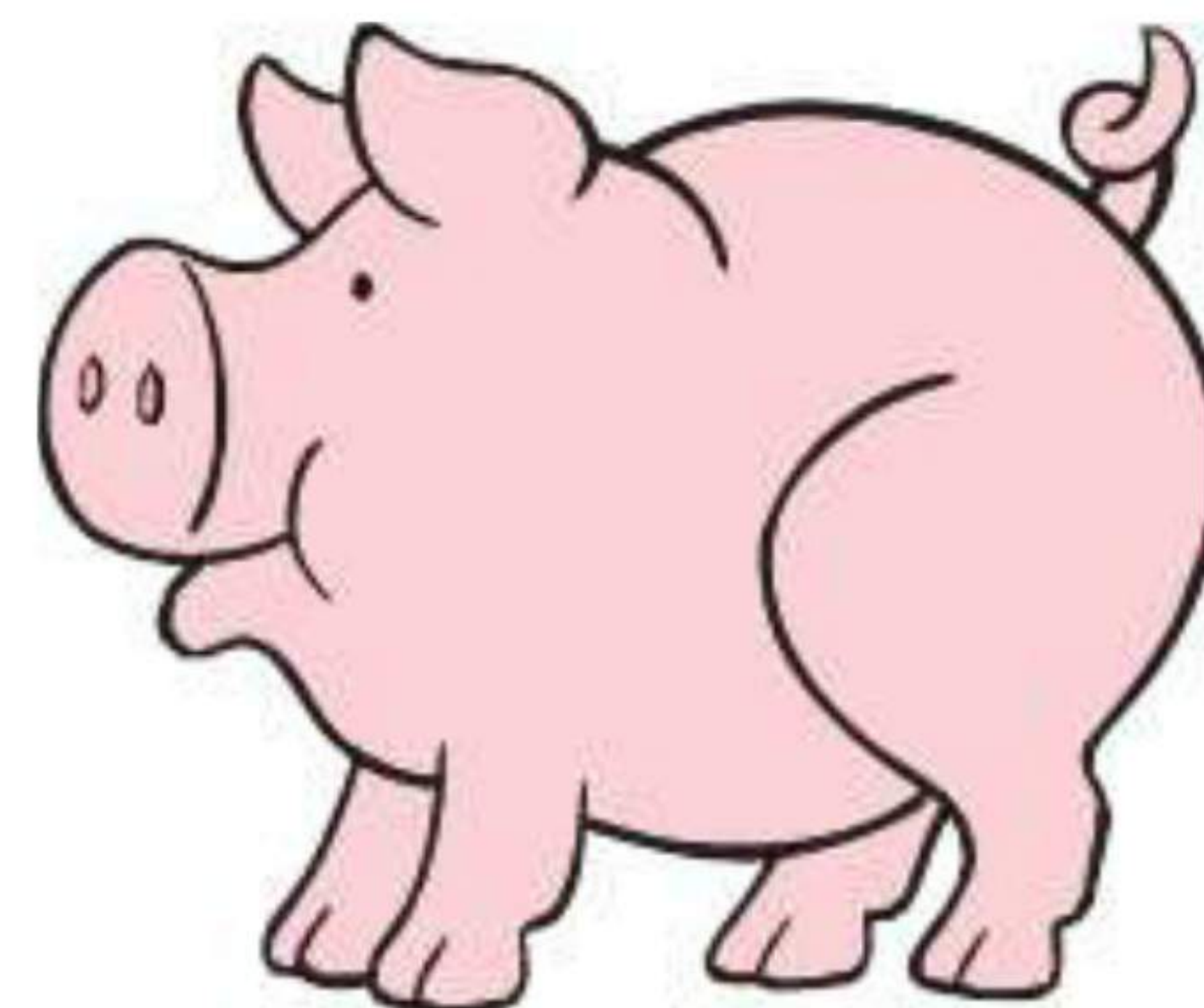

p g



p n



b d



Short Vowel Word Find

Directions: Find the words in the puzzle and circle them.

b	a	t	h	c	i	t
x	c	c	g	o	k	f
a	y	a	p	o	n	i
r	a	t	j	m	p	l
n	r	i	h	a	t	n



bat

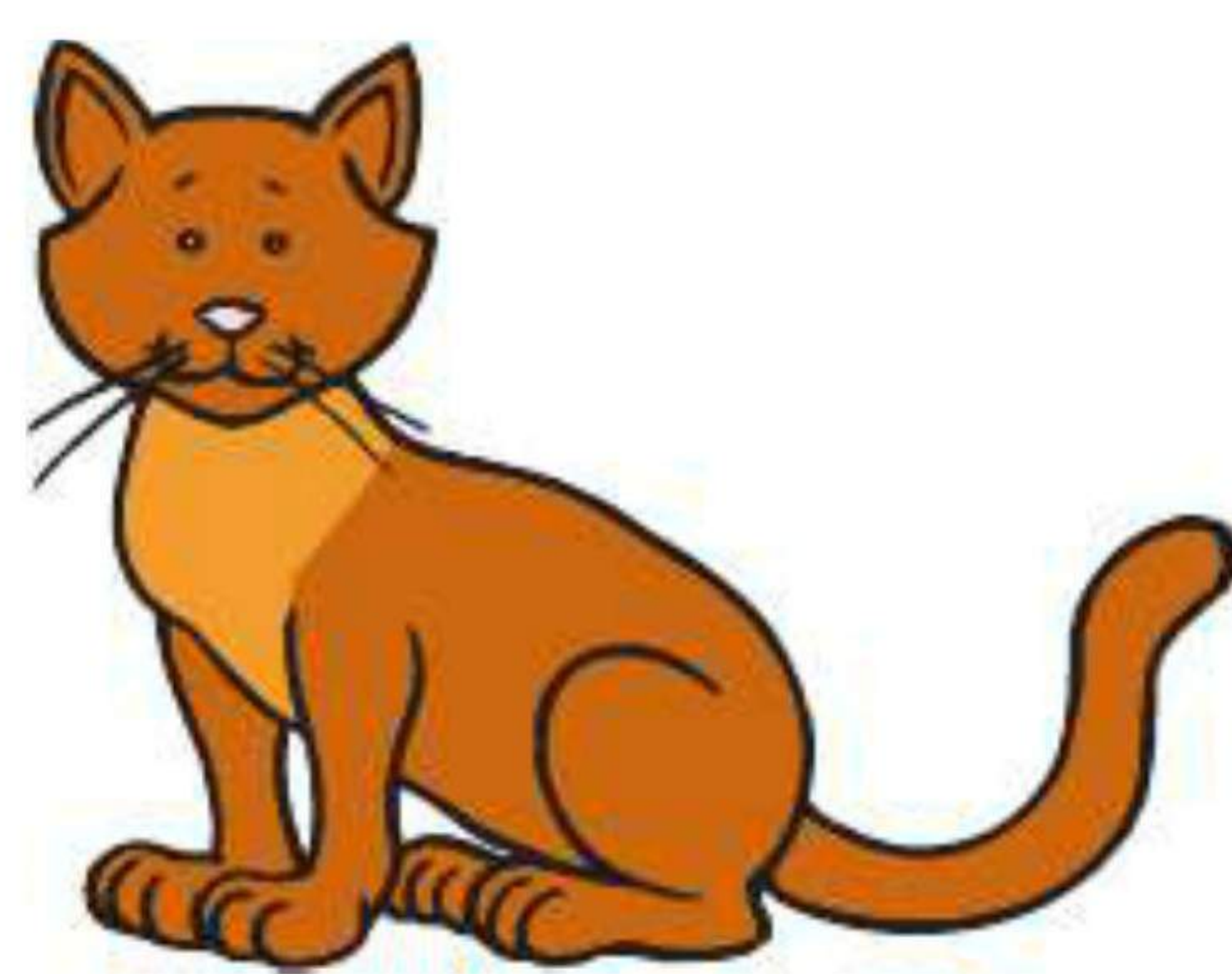

cat



rat



hat



Short Vowel Maze

Directions: Color your way through the maze by only coloring the vowels. Then, write the five vowels below.

start ↓

a	b	m	d	t	g	r
e	m	a	u	o	d	p
o	i	e	k	i	i	e
h	n	c	w	r	n	a
u	o	i	b	o	o	u
a	p	i	e	a	f	k
e	a	c	s	y	l	j

end ↓



Review: Short Vowels

Directions: Write two words with the same short vowel sound to describe the picture.

The _____ is _____.



The _____ is _____.

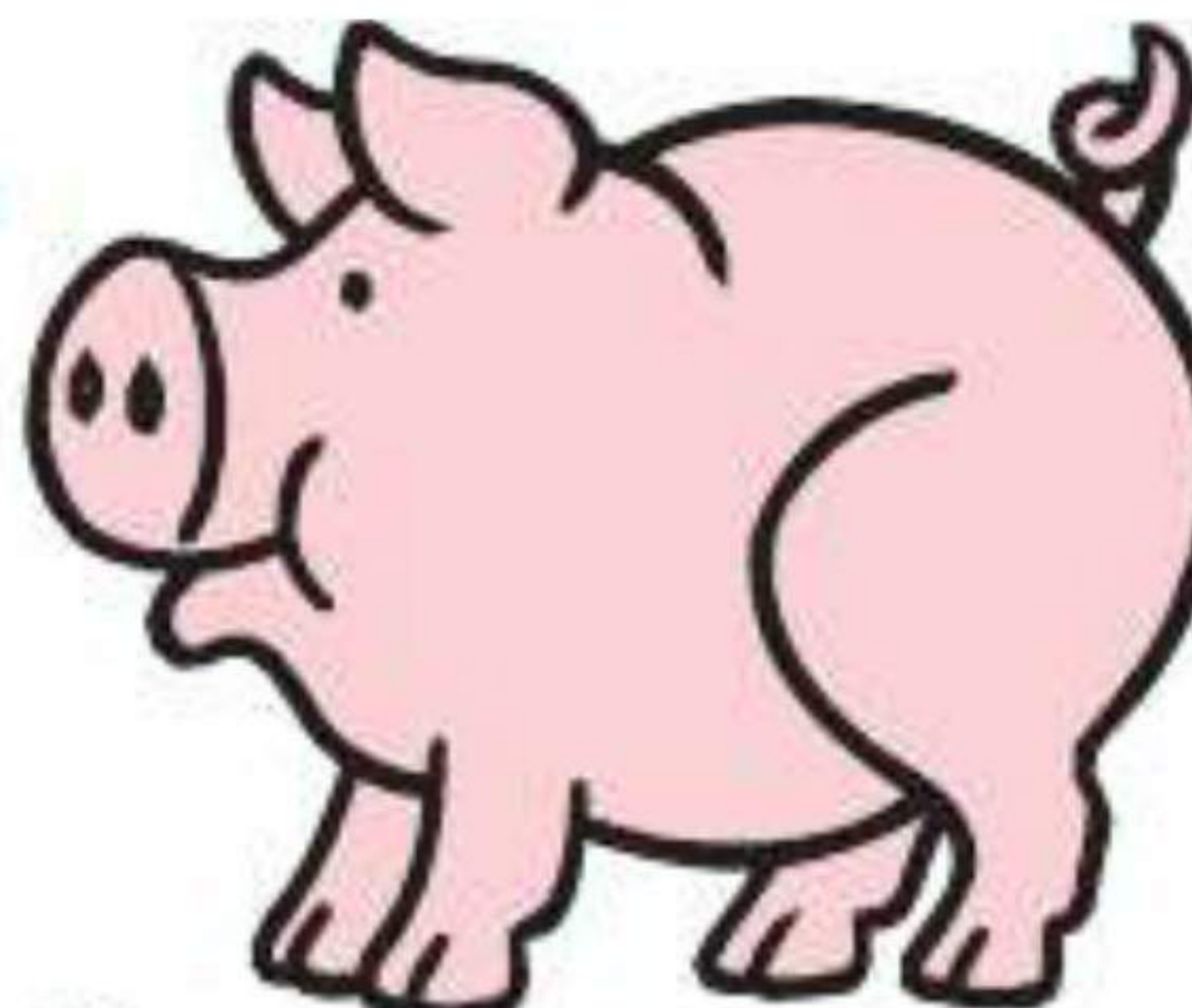

The _____ is _____.





Rhyming Pairs

Directions: Words that have the same ending sounds are called **rhyming** words. Circle the pairs that rhyme.

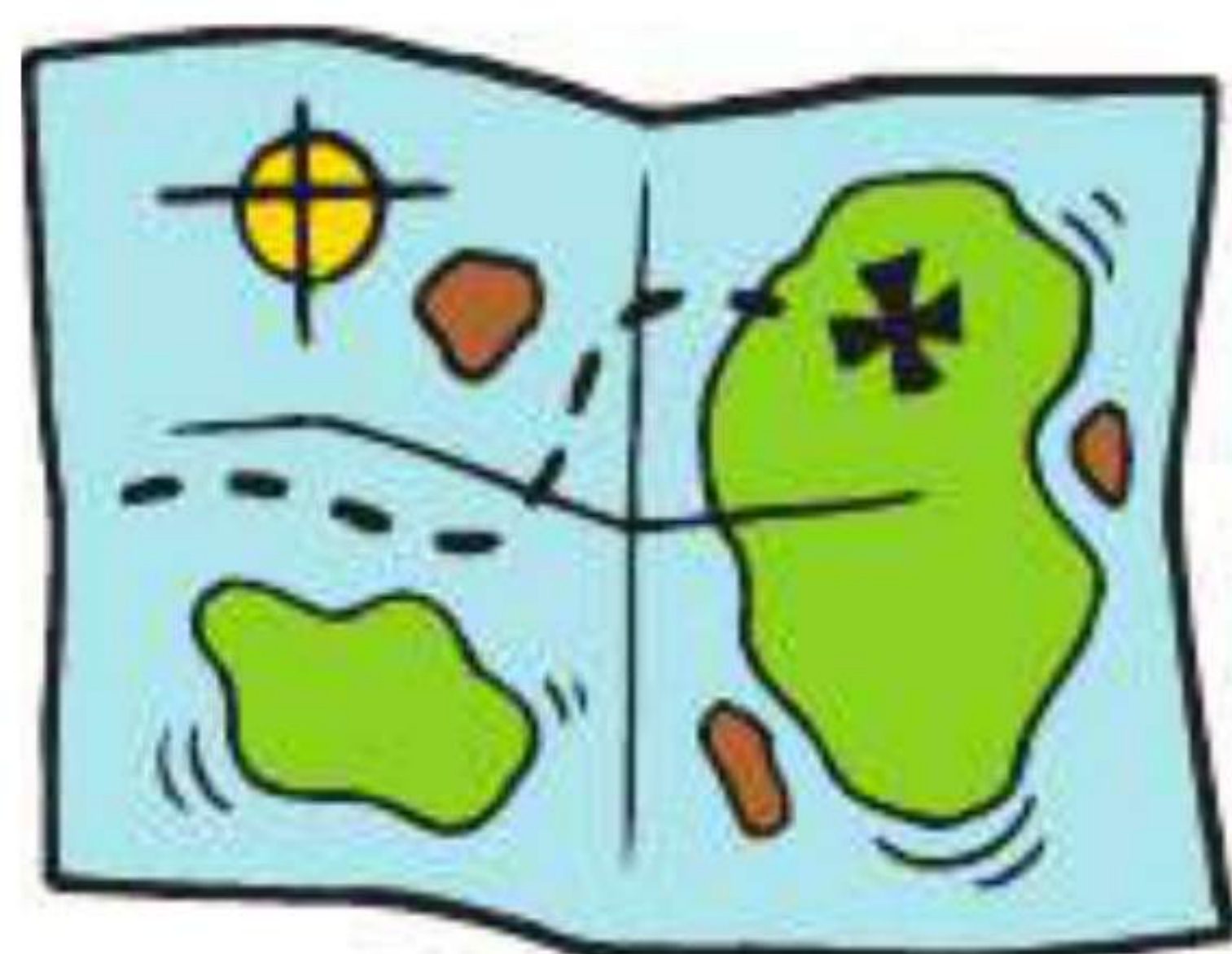

map

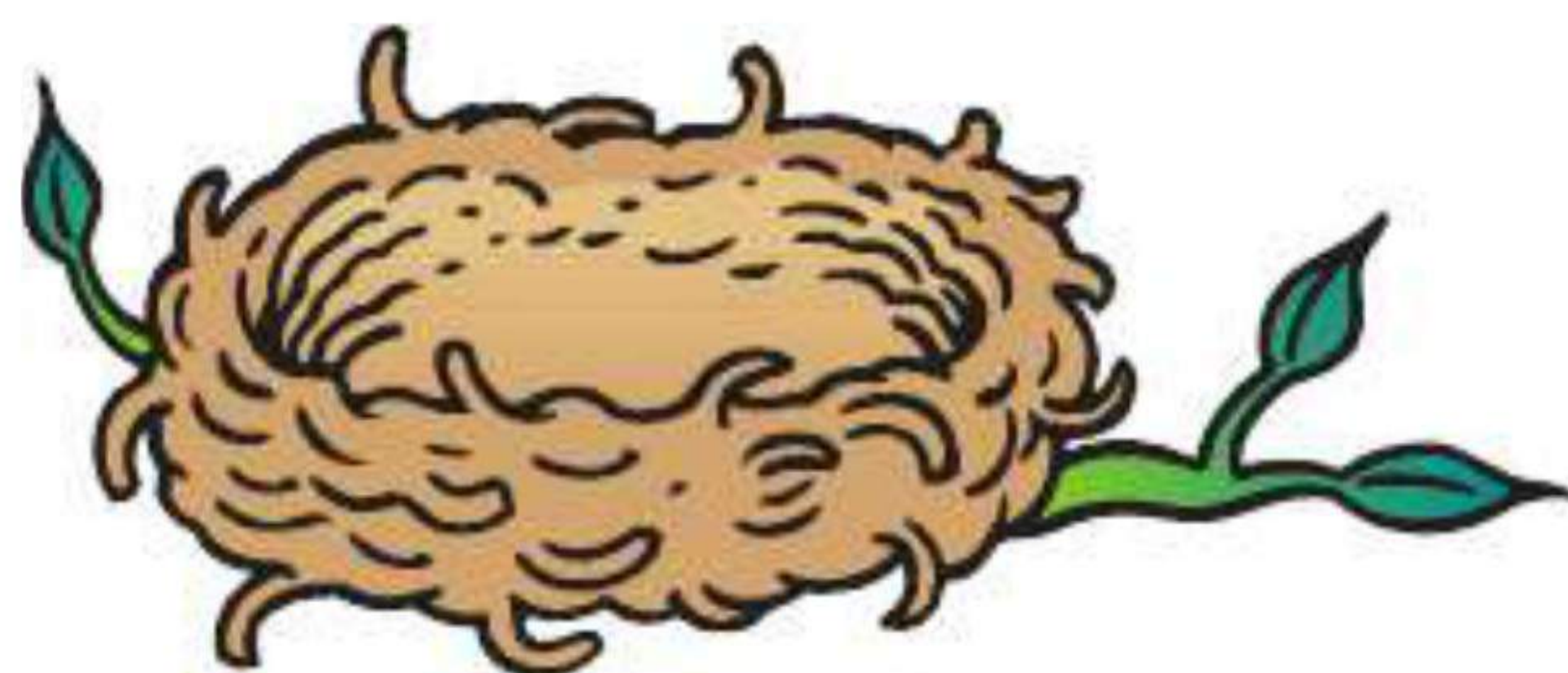

nest



dog



frog



hat



bat



kite

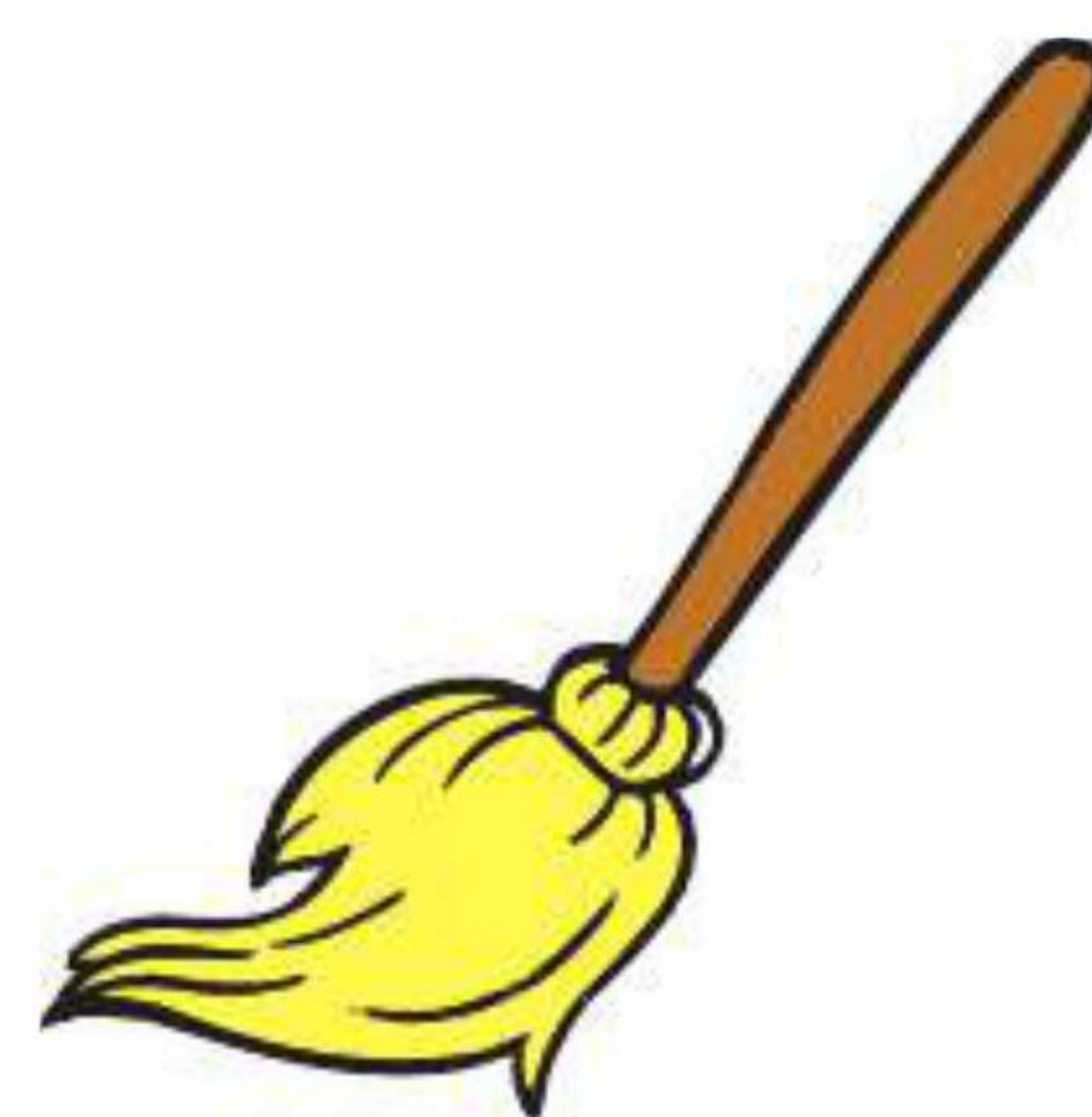

mop



can



fan



rat

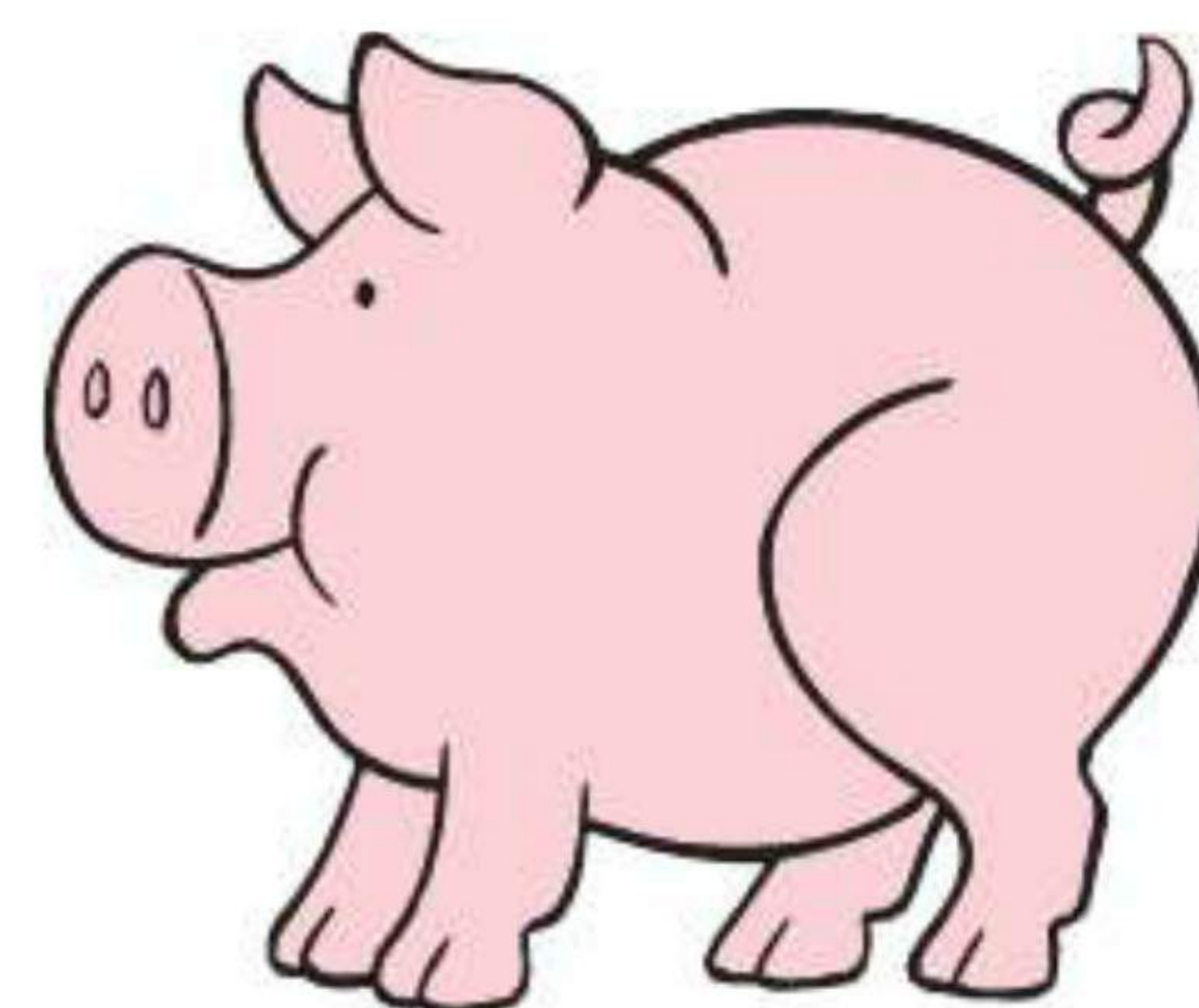

pig



Rhyming Pairs

Directions: Think of a word that rhymes with each picture. Draw a picture. Write the word.

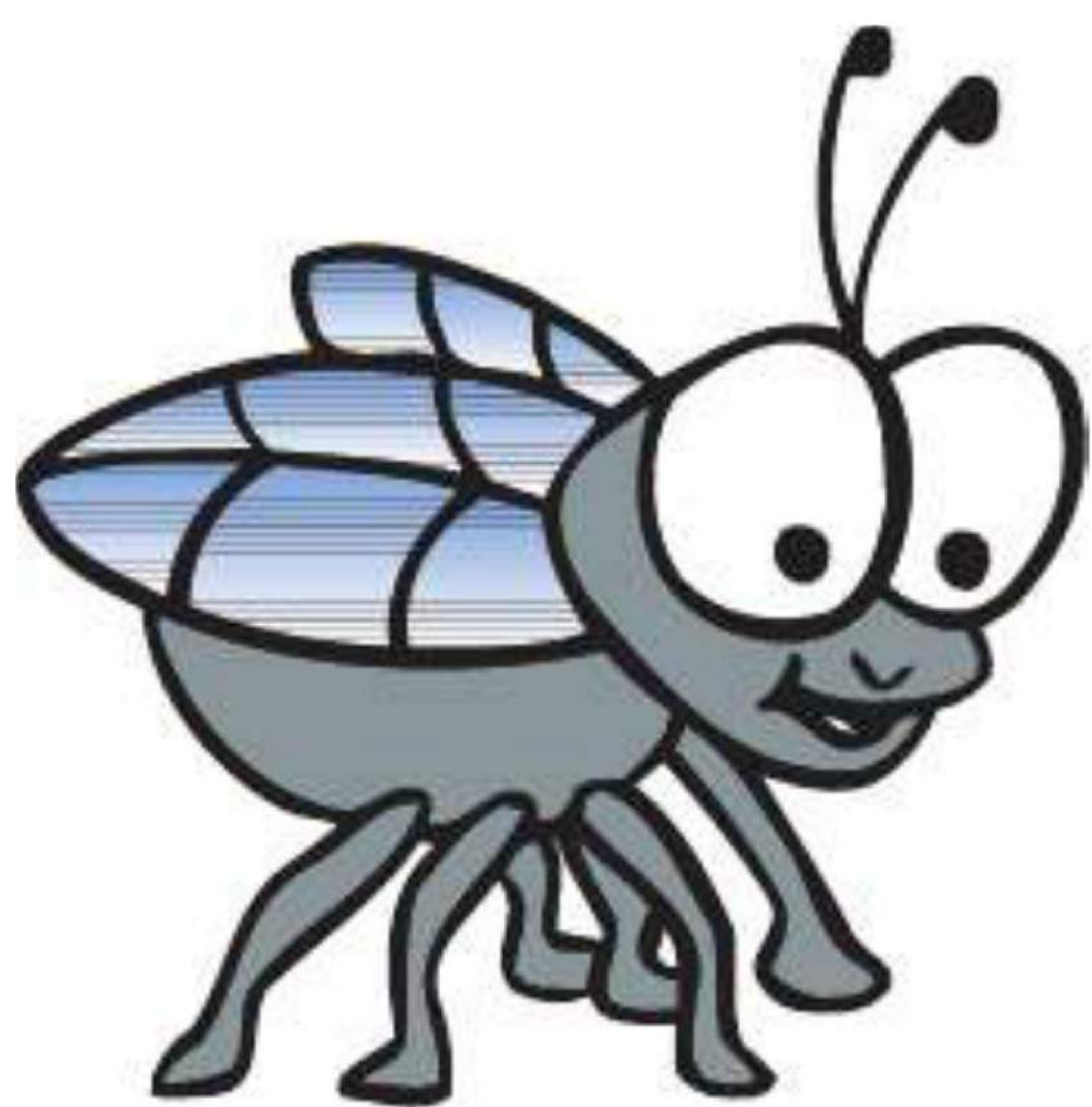

bug

Blank writing area with a solid top line, a dashed middle line, and a solid bottom line.



frog

Blank writing area with a solid top line, a dashed middle line, and a solid bottom line.



Rhyming Pairs

Directions: Think of a word that rhymes with each picture. Draw a picture. Write the word.

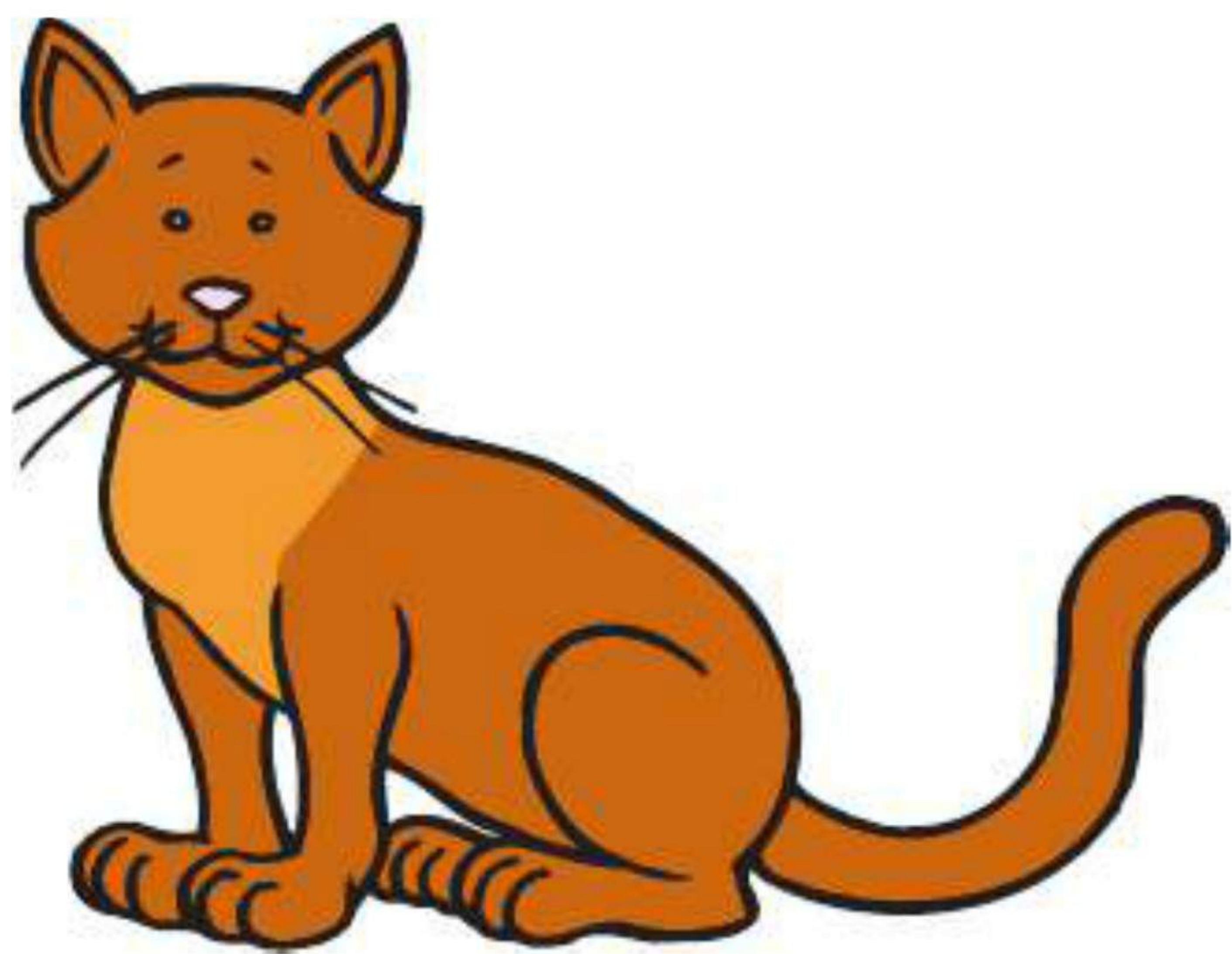

cat

Blank writing area with a top blue line, a middle dashed red line, and a bottom blue line.



pan

Blank writing area with a top blue line, a middle dashed red line, and a bottom blue line.



Rhyme Time

Directions: Read the poem. Read the questions. Circle the correct answer.



Jack and Jill went up the hill,
To fetch a pail of water.
Jack fell down and broke his crown,
And Jill came tumbling after.

◆ Who went up the hill?



◆ What were they going to fetch?



◆ Who fell down?





Word Recognition: Colors

Directions: Color each picture the correct color.

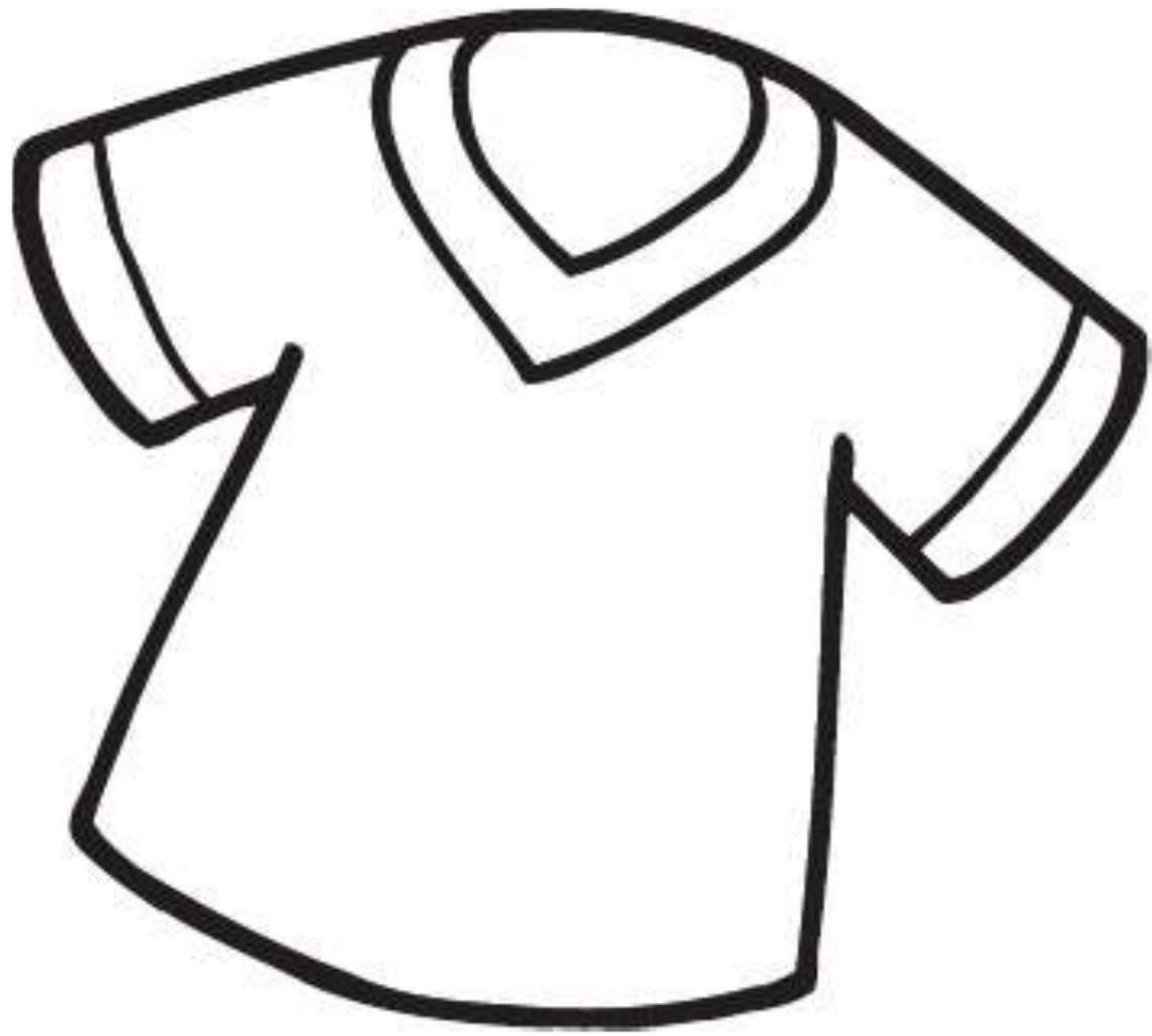

red shirt

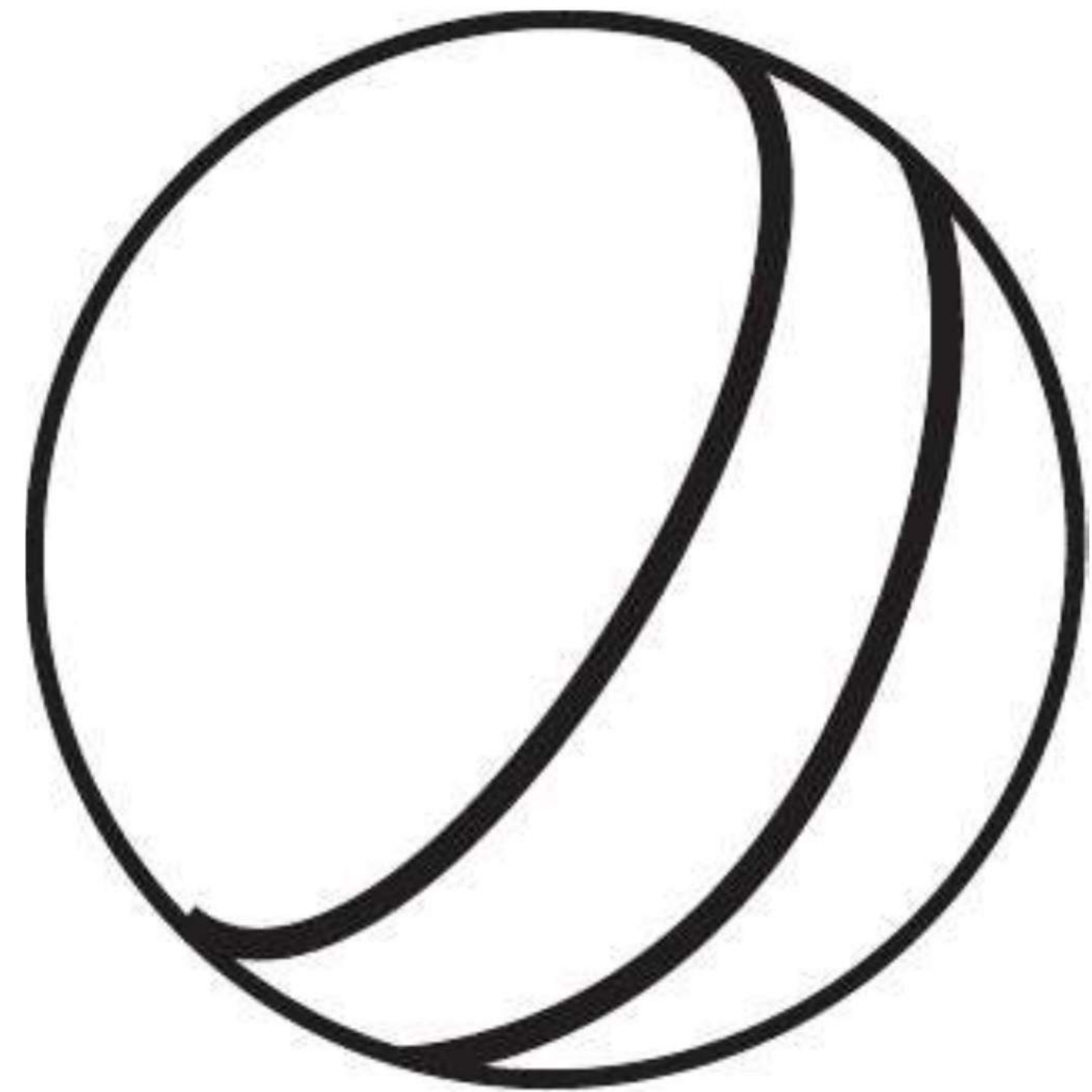

yellow ball

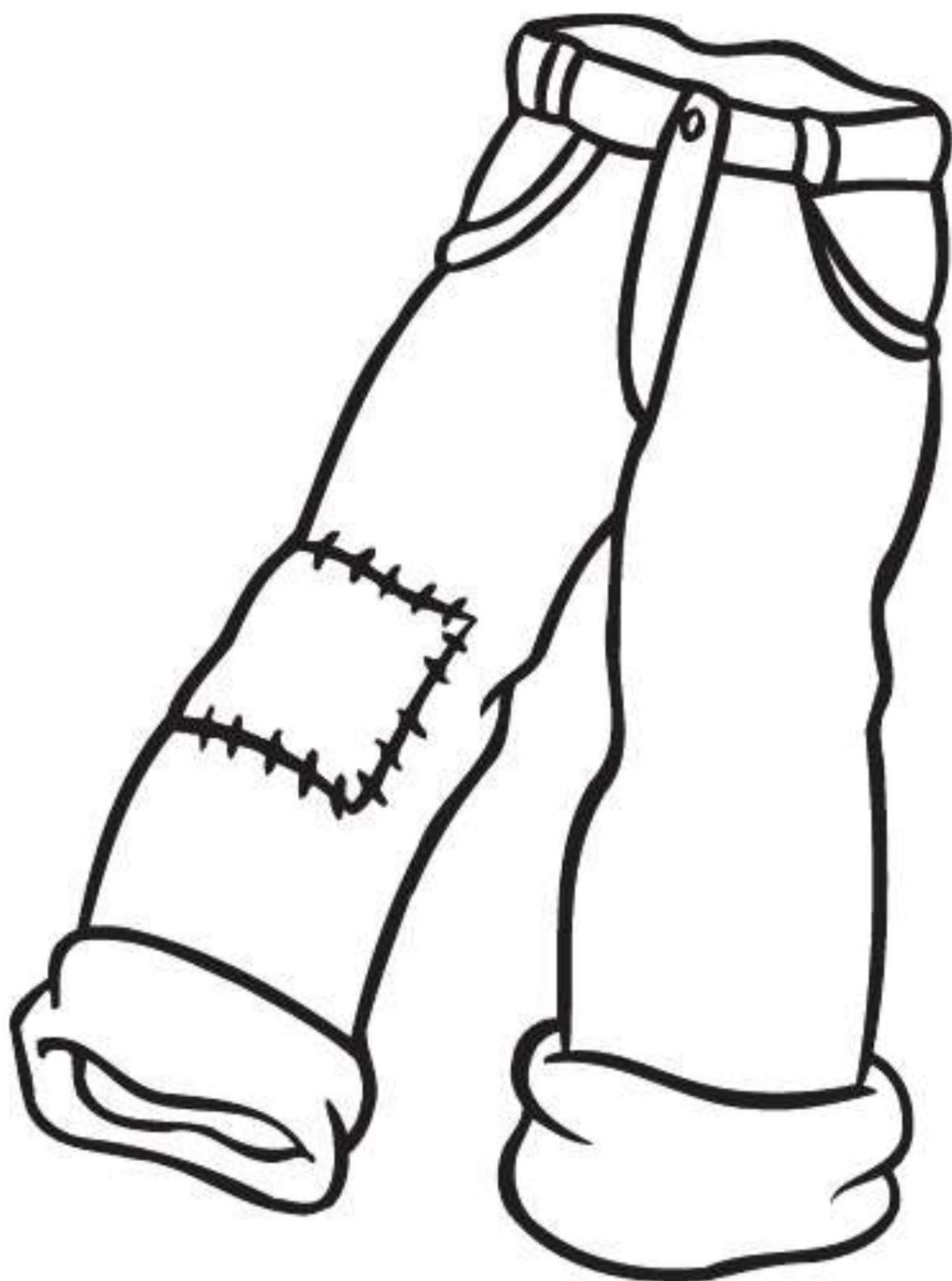

blue pants

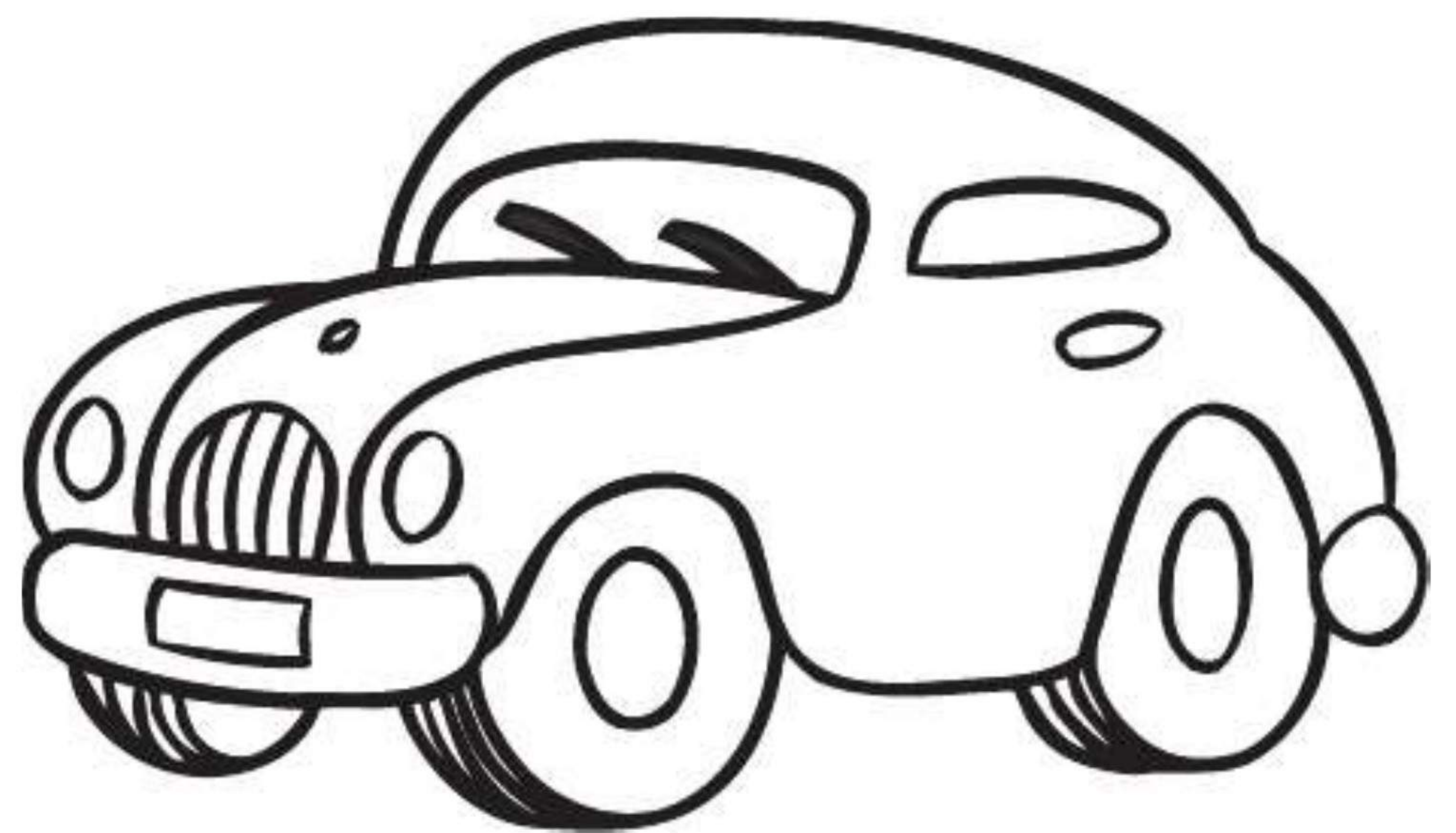

green car



Word Recognition: Colors

Directions: Color each picture the correct color.

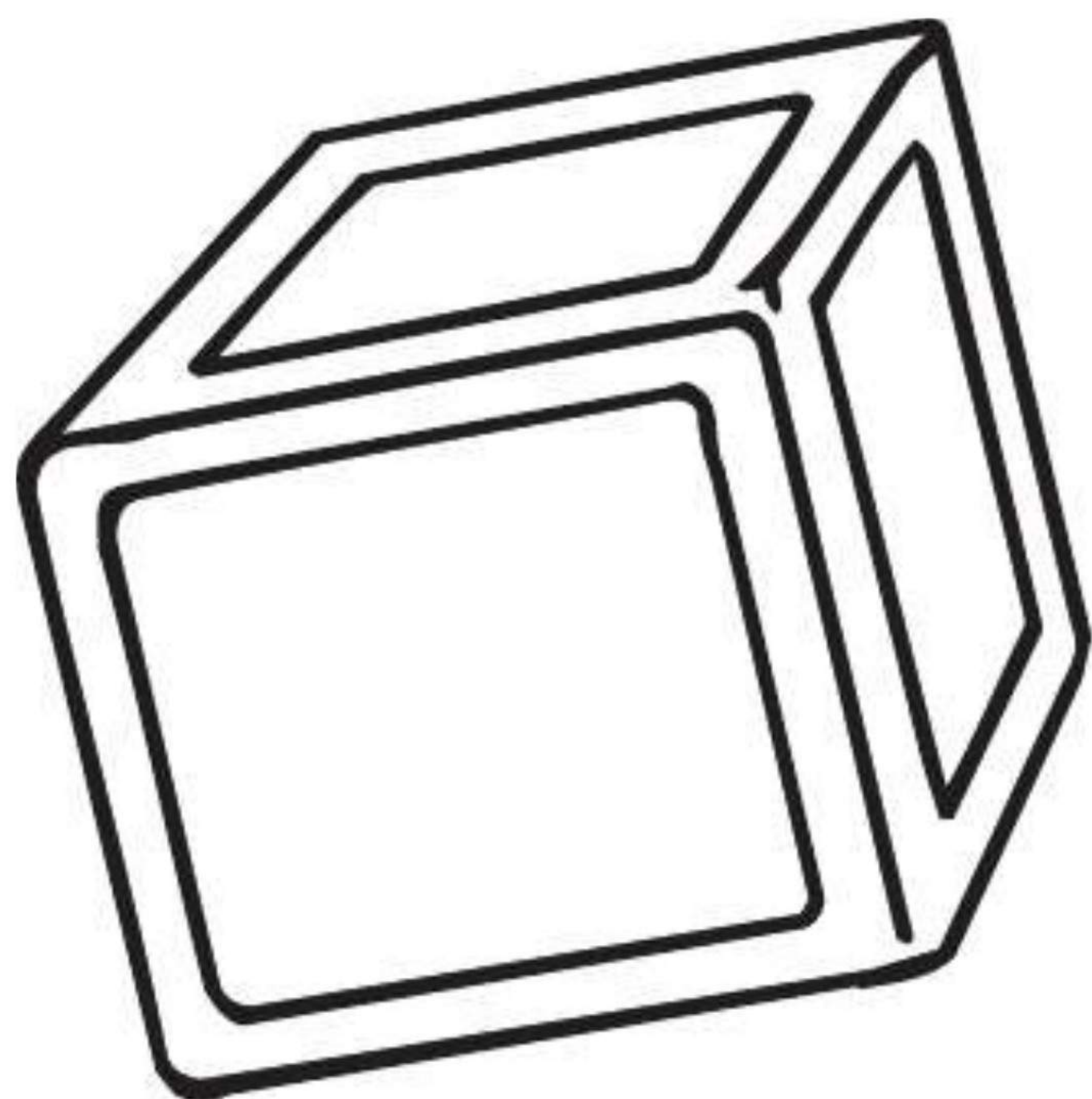

orange block

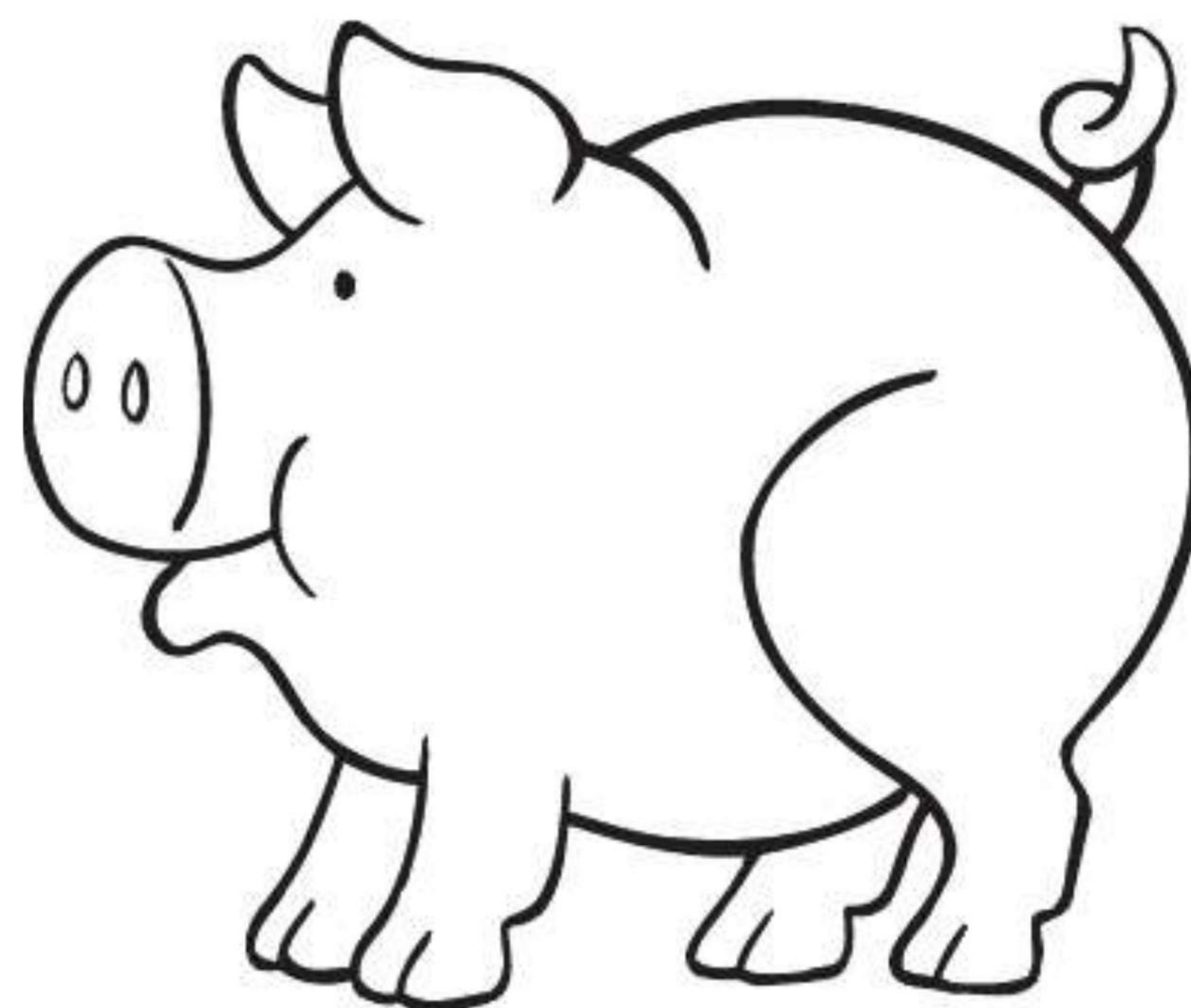

pink pig



purple balloon



brown bear

MATH READINESS





After

Directions: Circle the small picture that shows what will happen after the pictures in the large boxes.

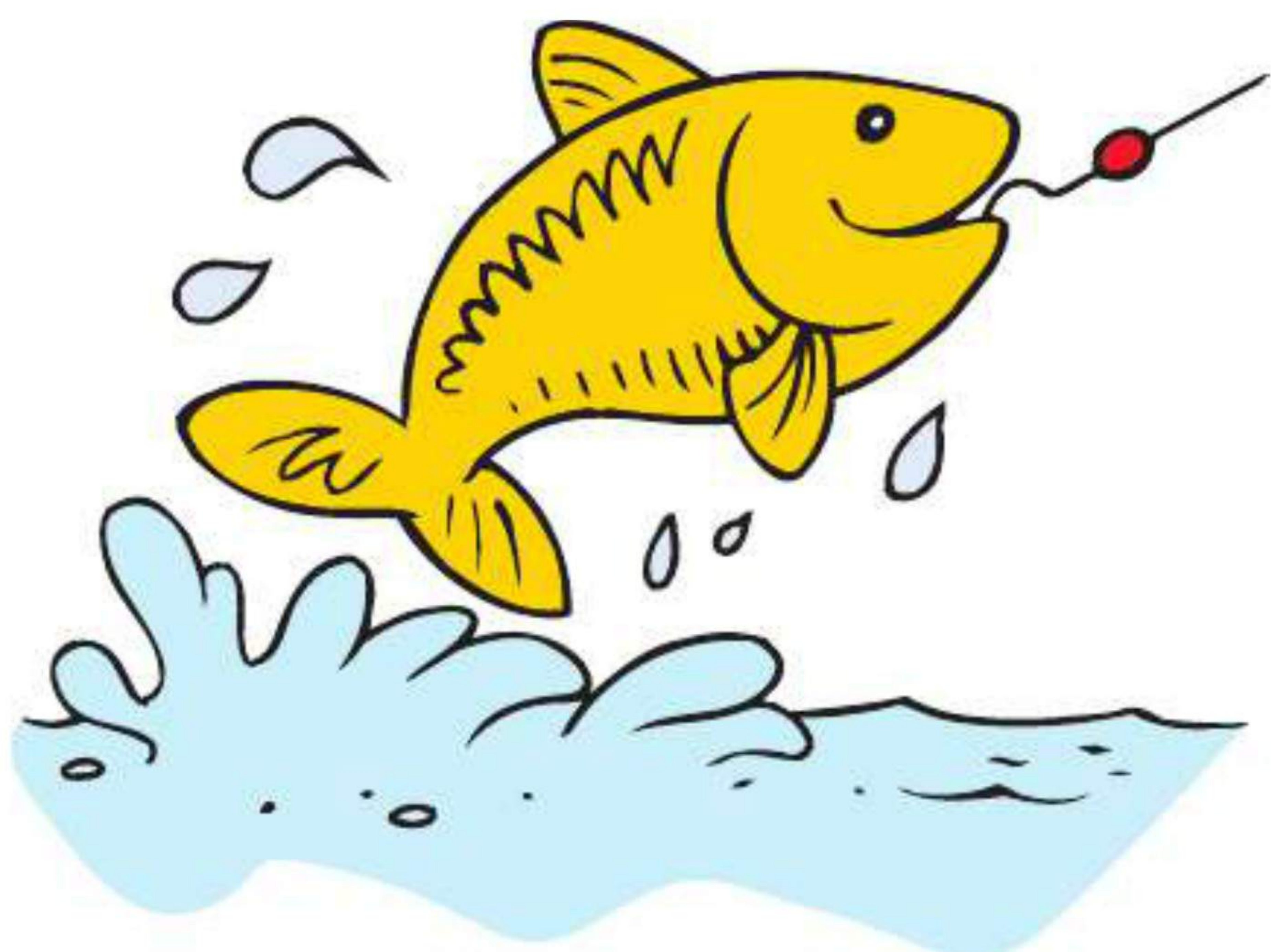
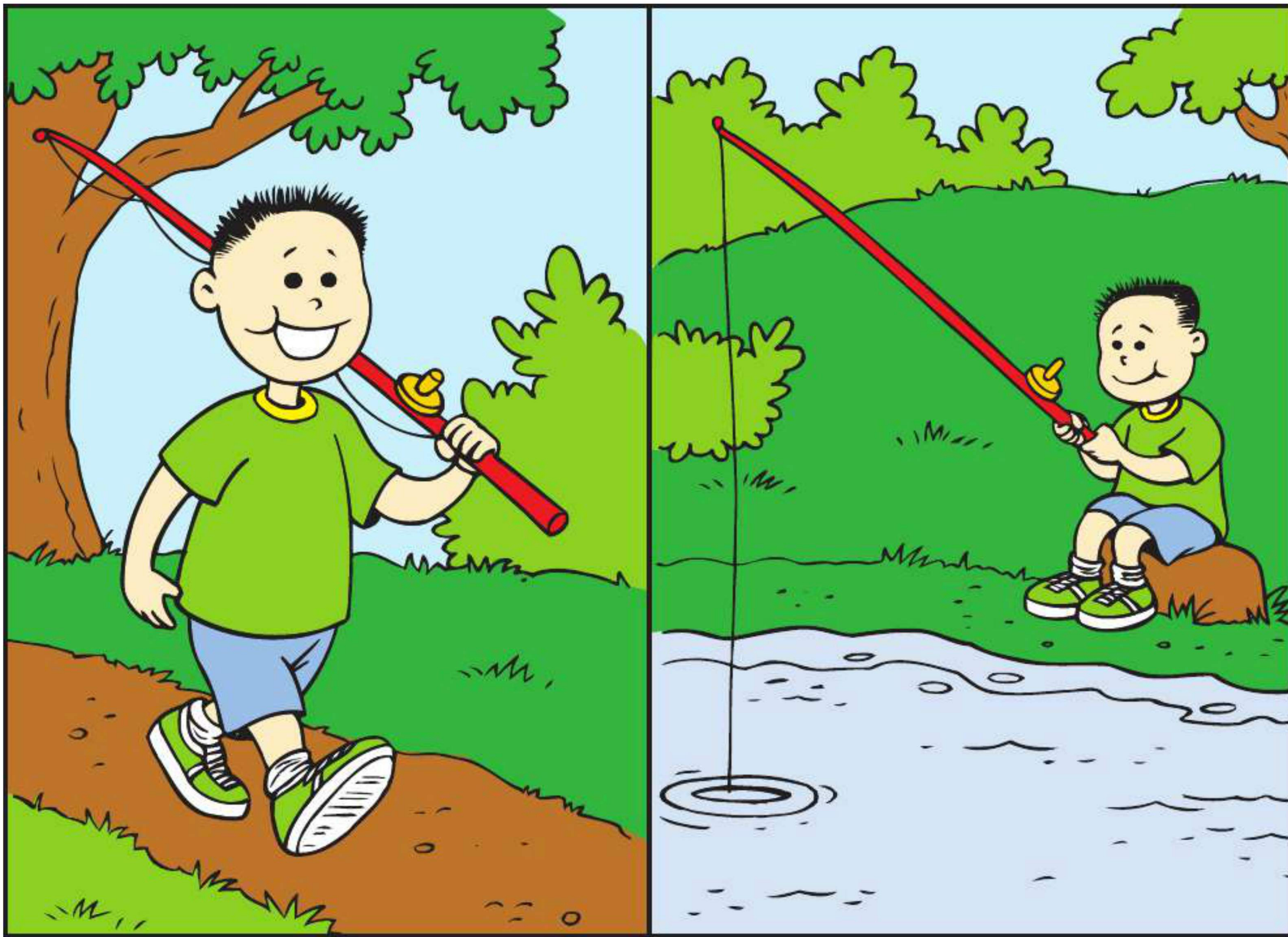



After

Directions: Circle the small picture that shows what will happen after the pictures in the large boxes.

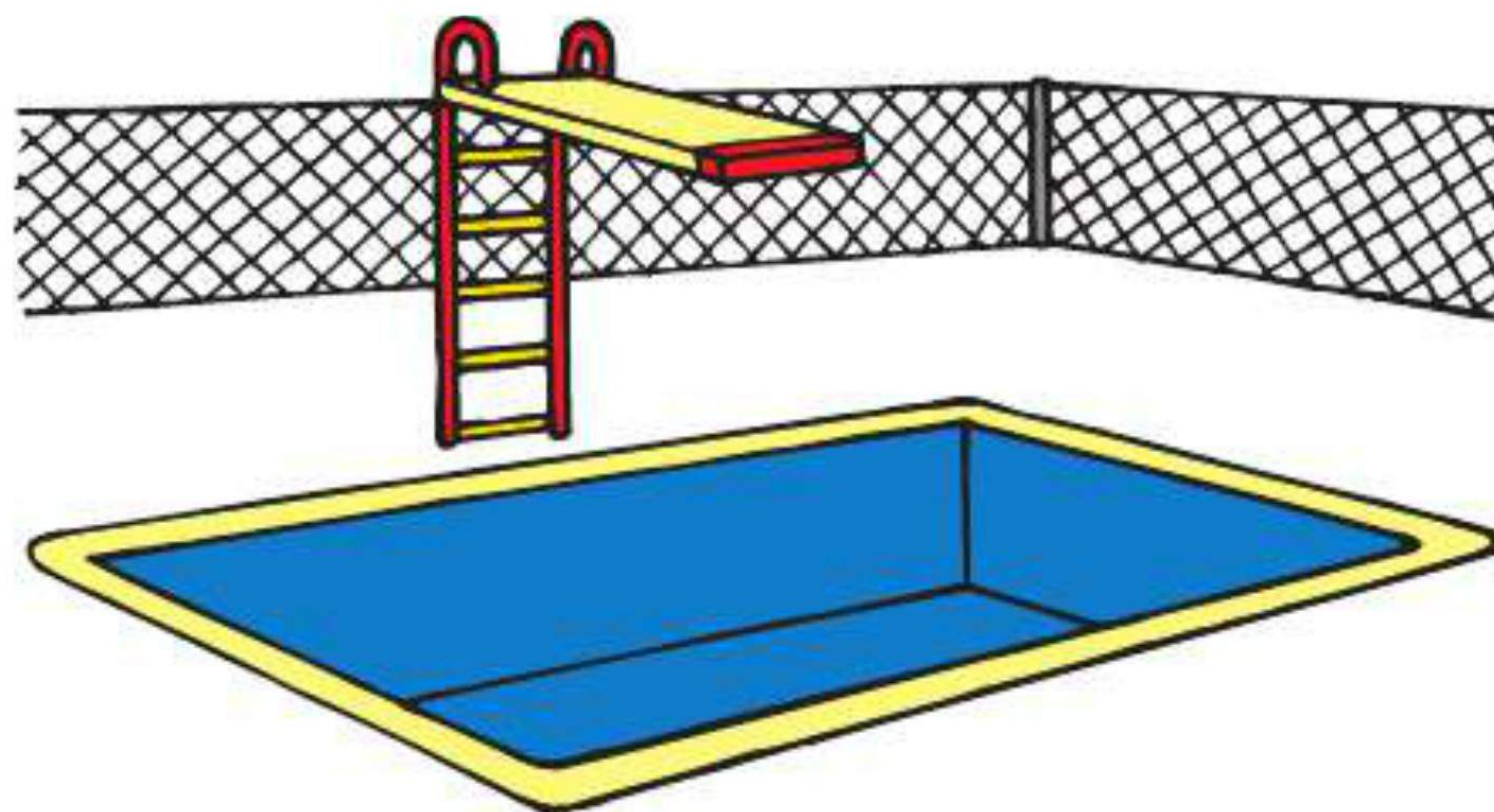
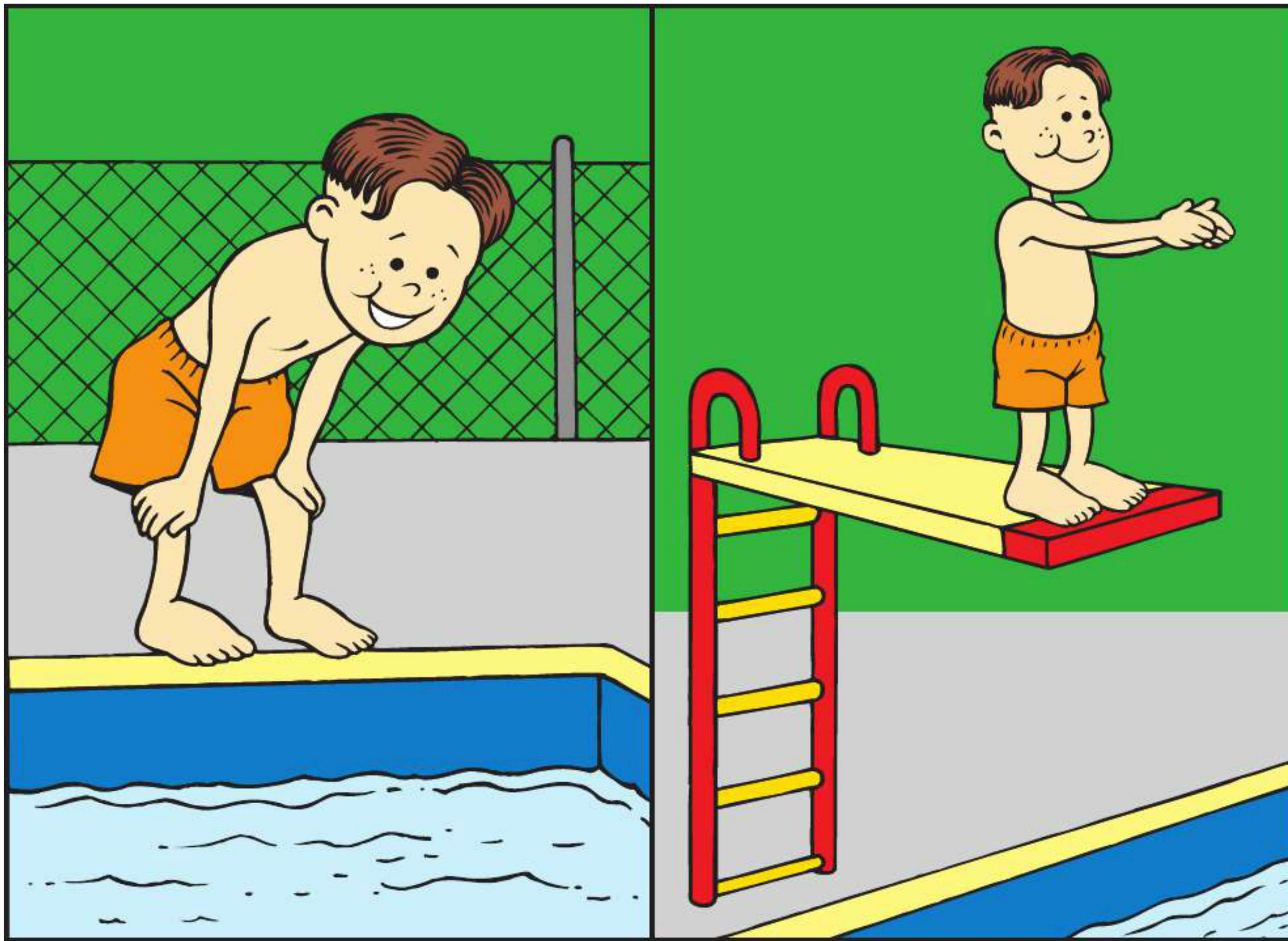



Before

Directions: Circle the small picture that shows what happened right before the pictures in the large boxes.

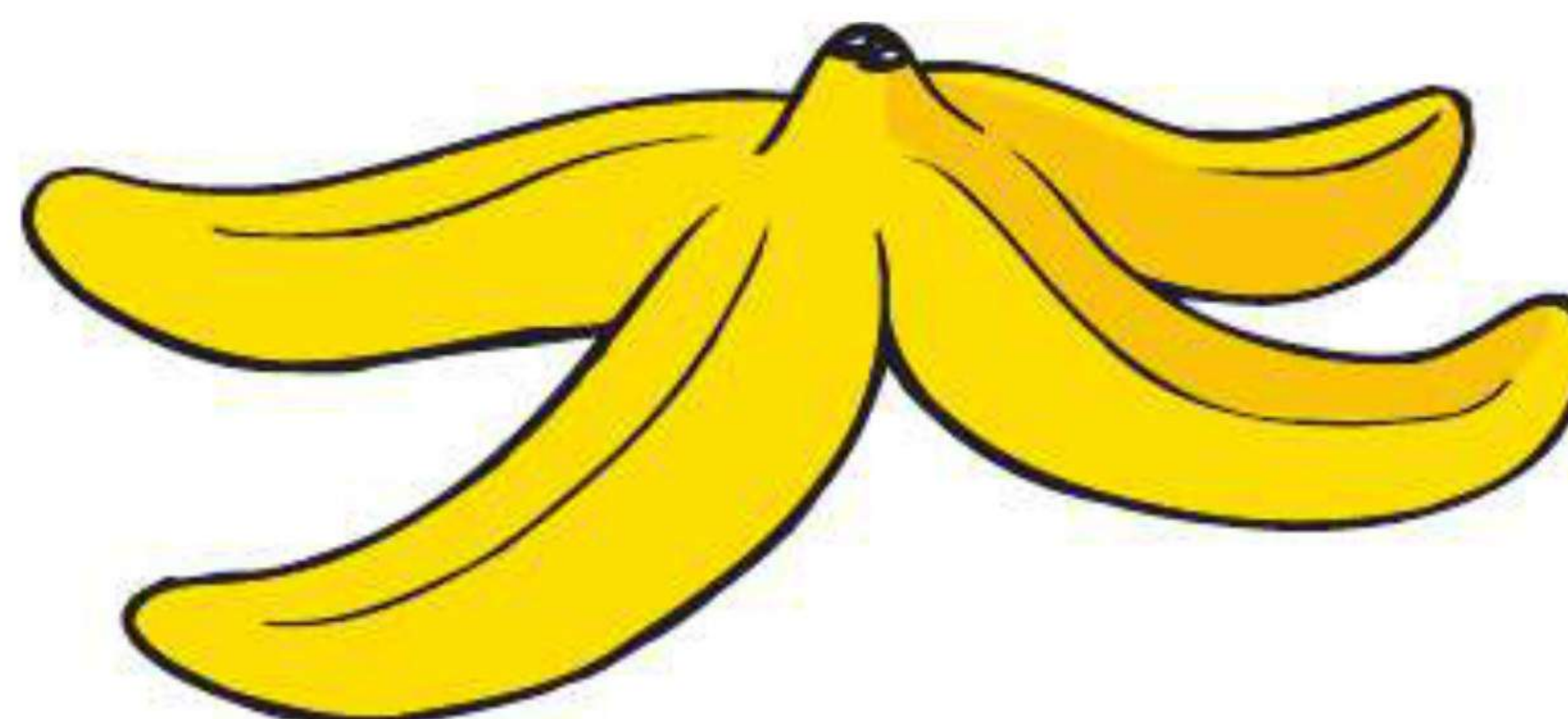
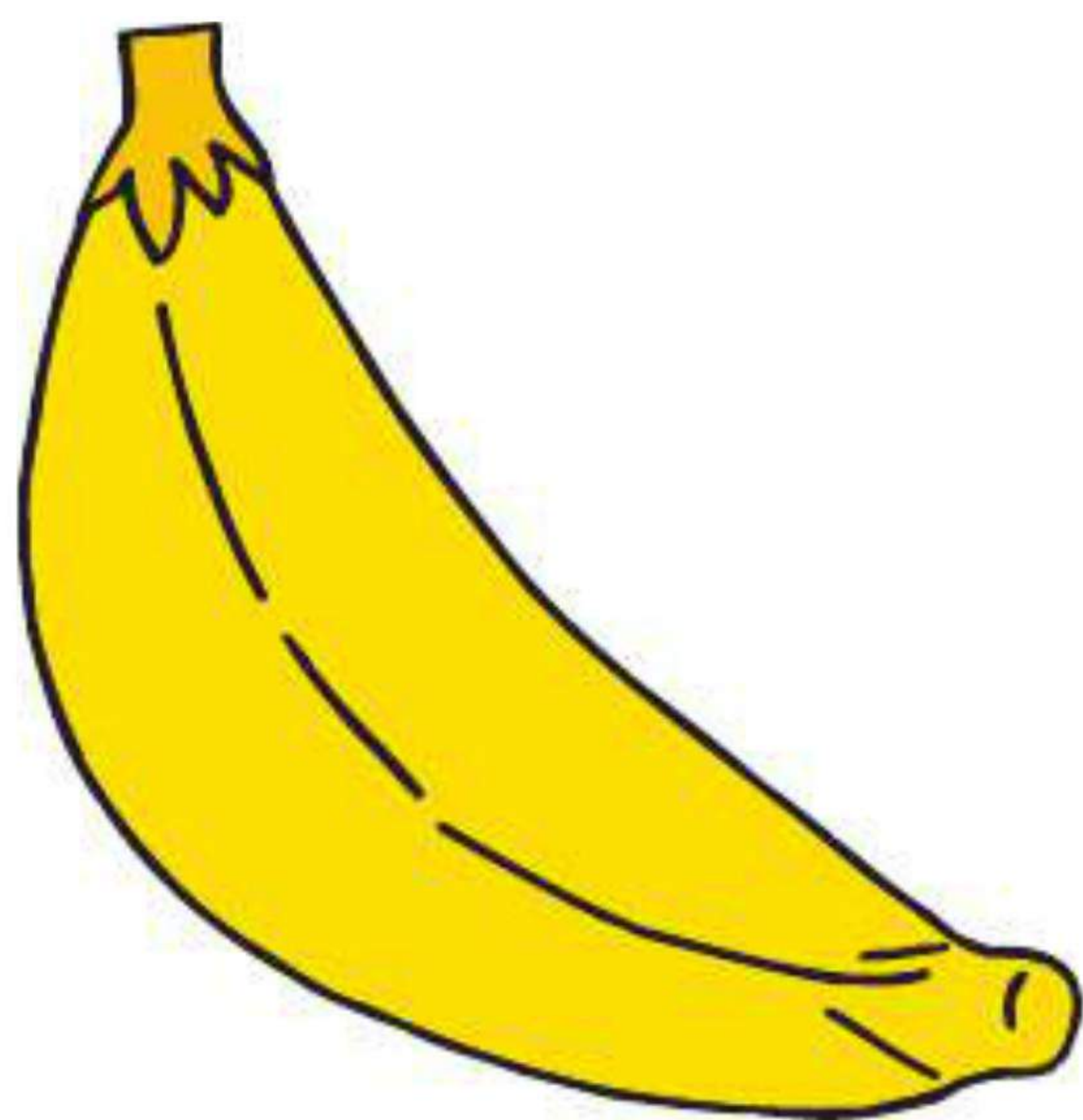
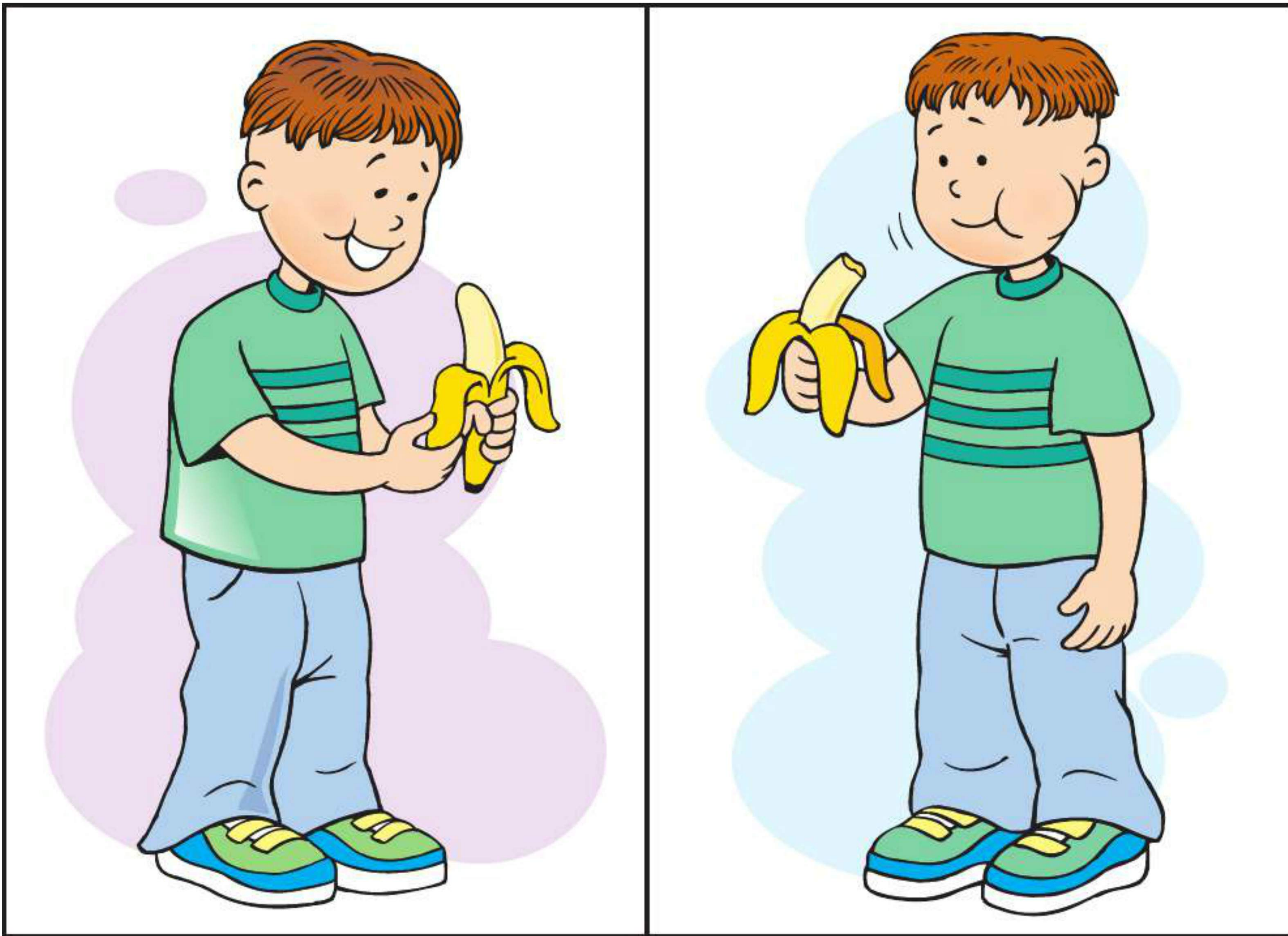



Before

Directions: Circle the small picture that shows what happened right before the pictures in the large boxes.





Before

Directions: Circle the small picture that shows what happened right before the pictures in the large boxes.

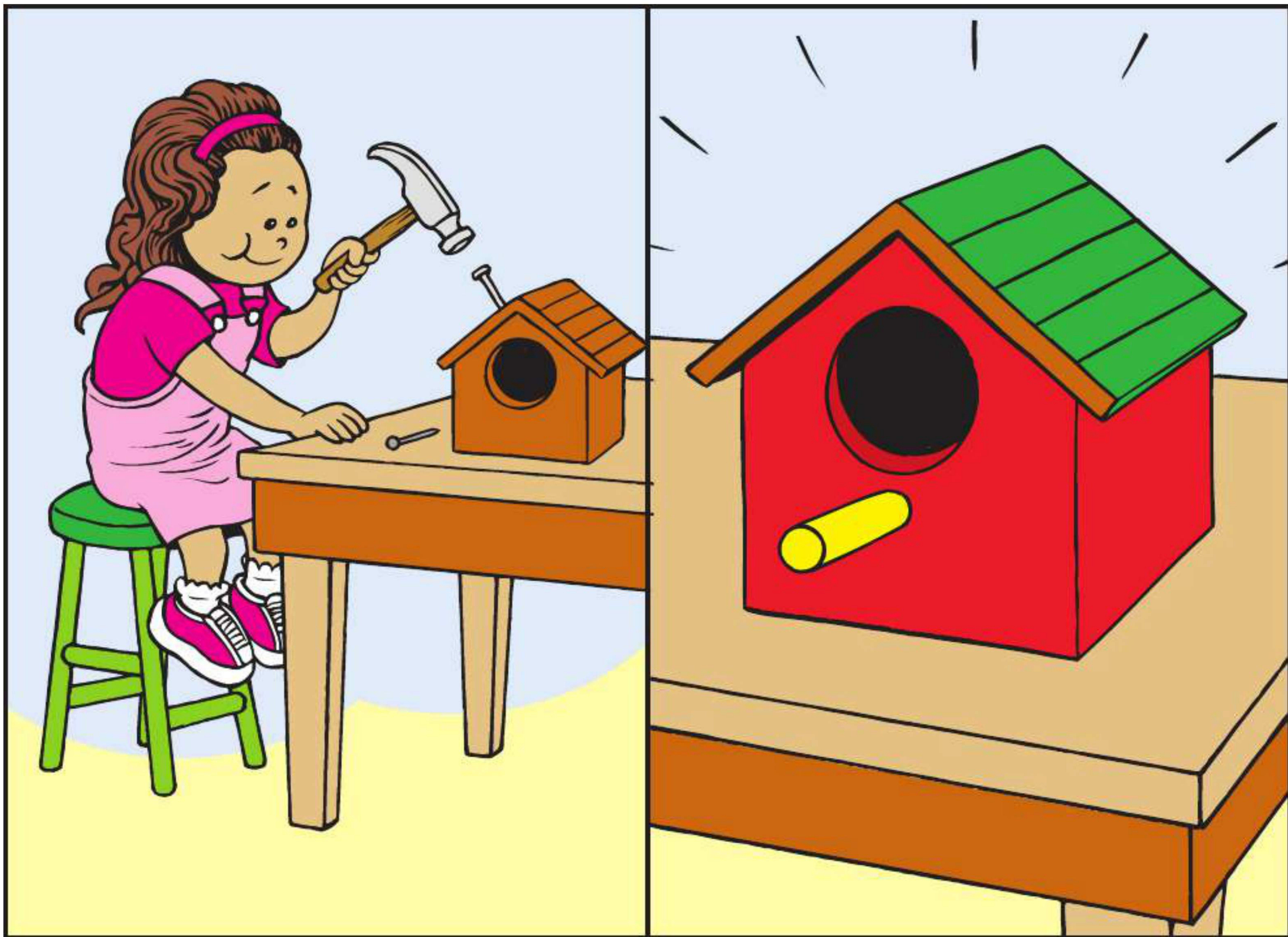



Sequencing

Directions: Cut out the pictures below. Put them in the correct order. Draw what you think will happen next.

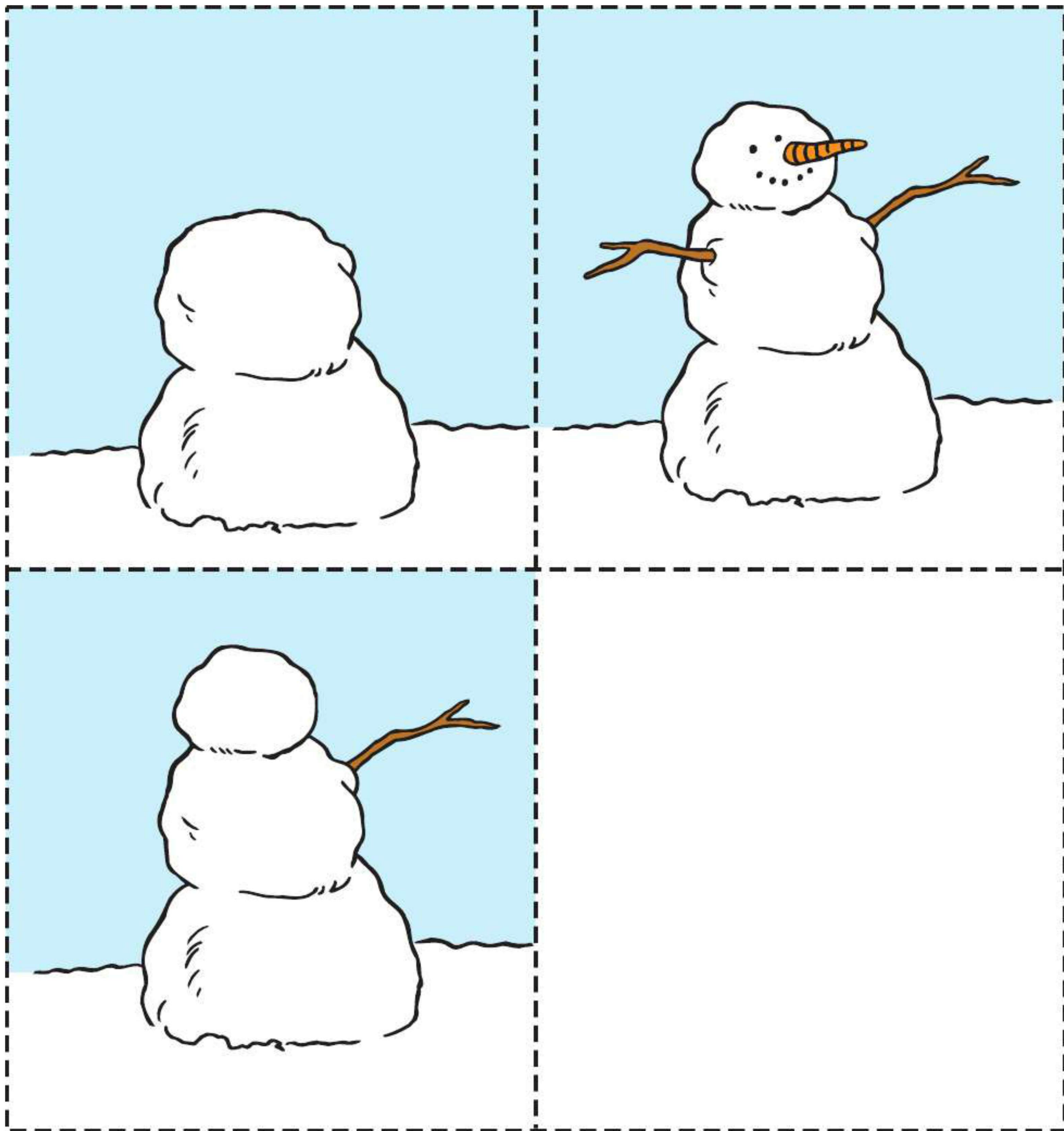



Sequencing

Directions: Cut out the pictures below. Put them in the correct order. Draw what you think will happen next.

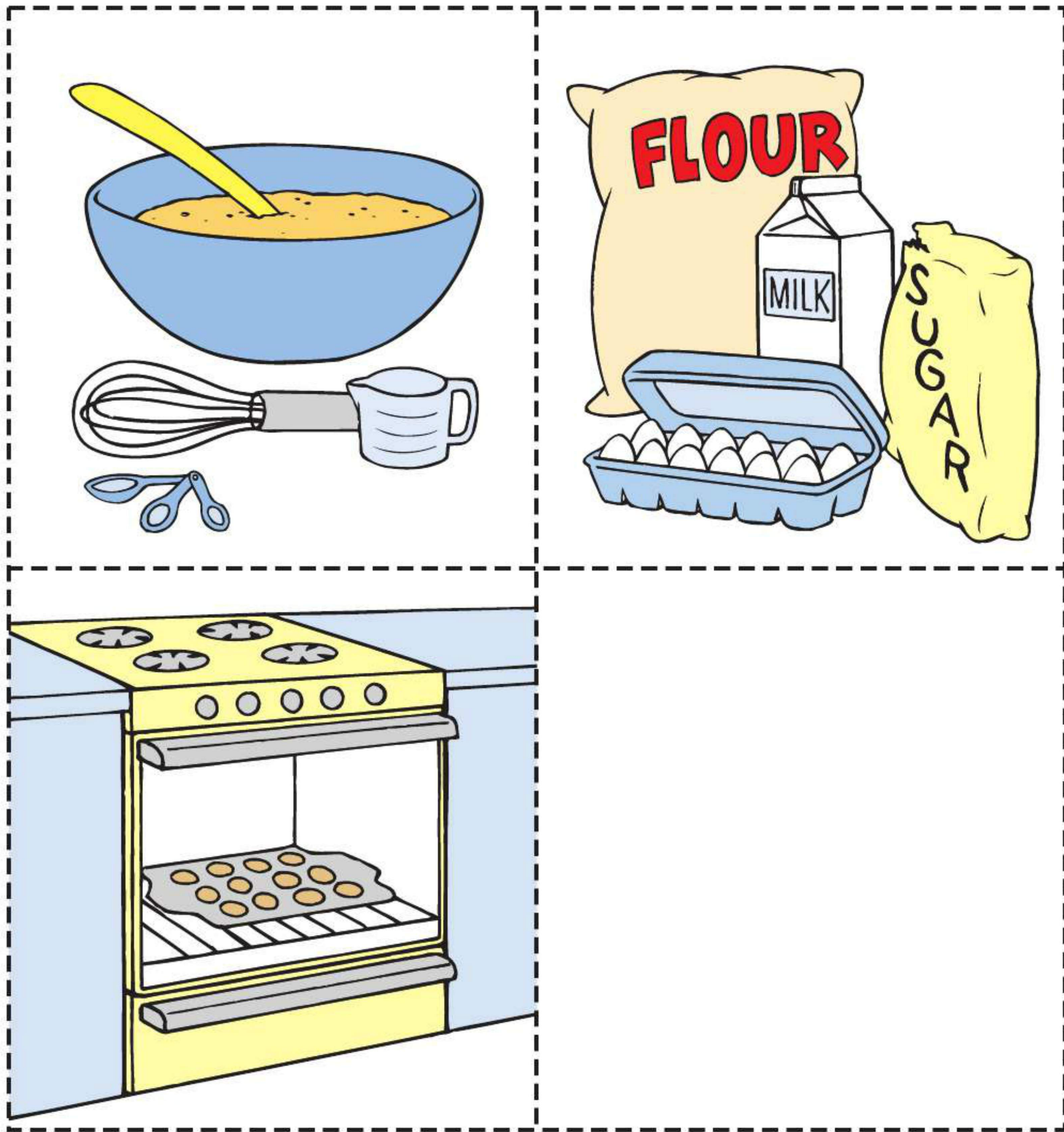



First

Directions: Look at the pictures in each row. Circle the picture that shows what happened first.

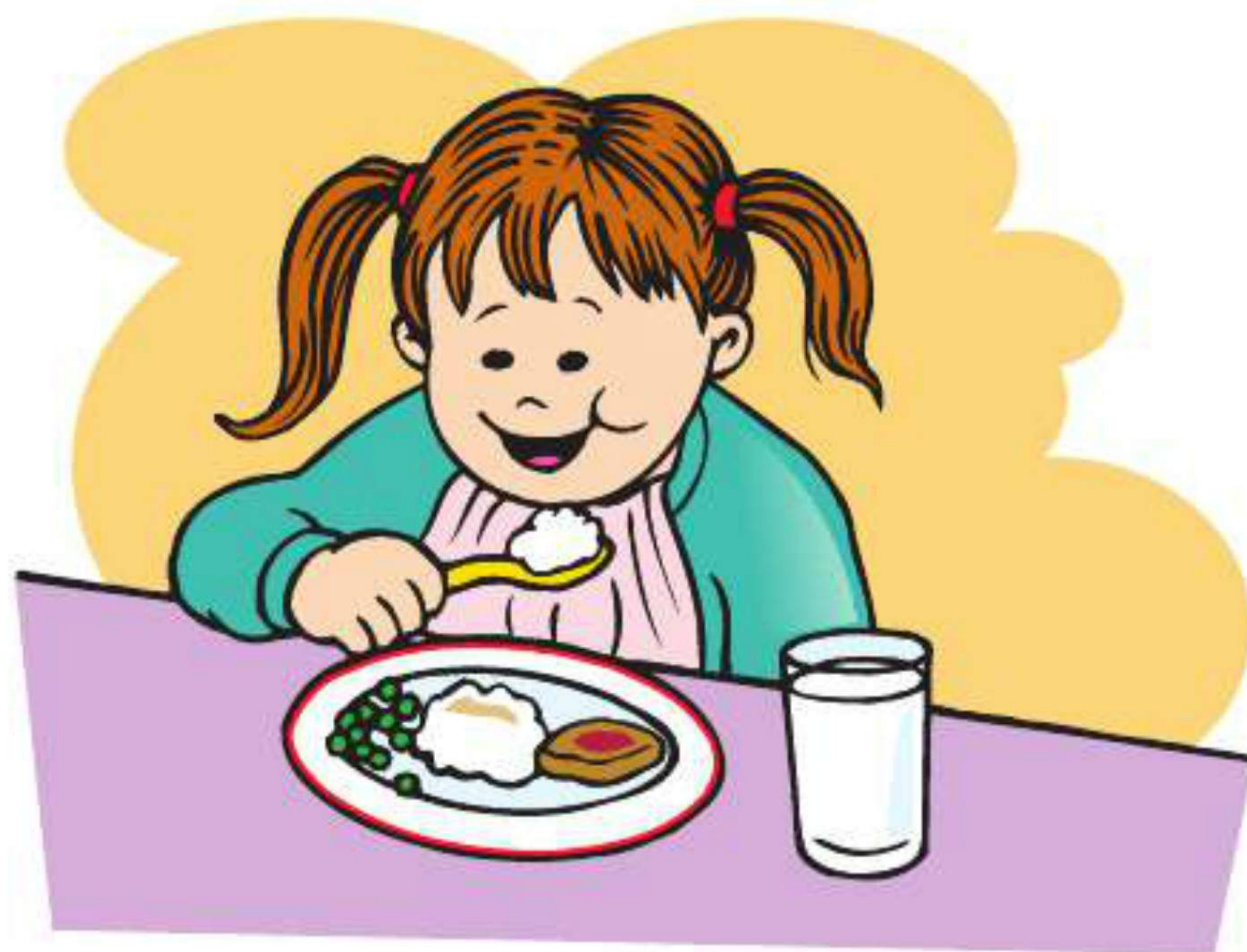
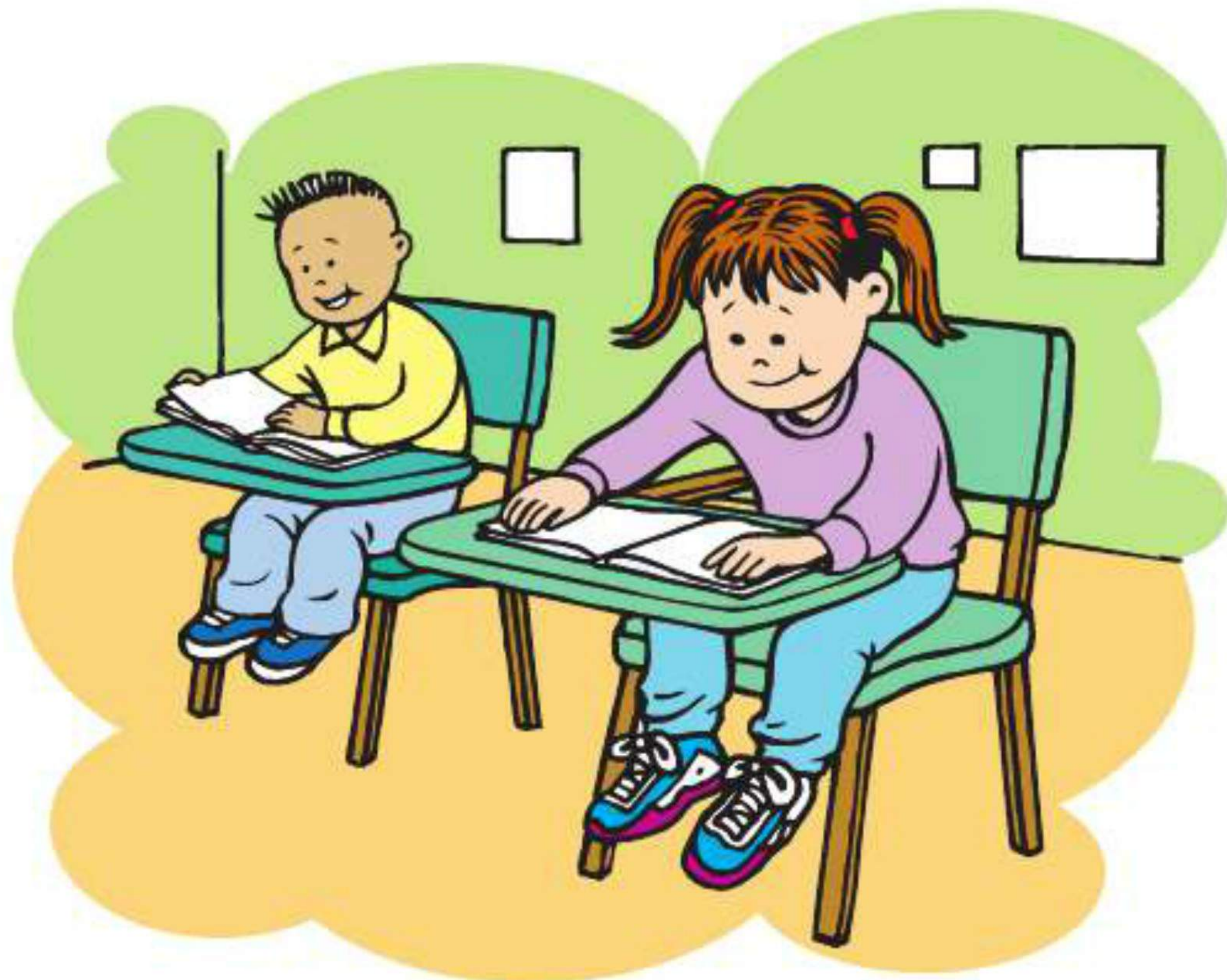



Second

Directions: Circle the second thing in each row.

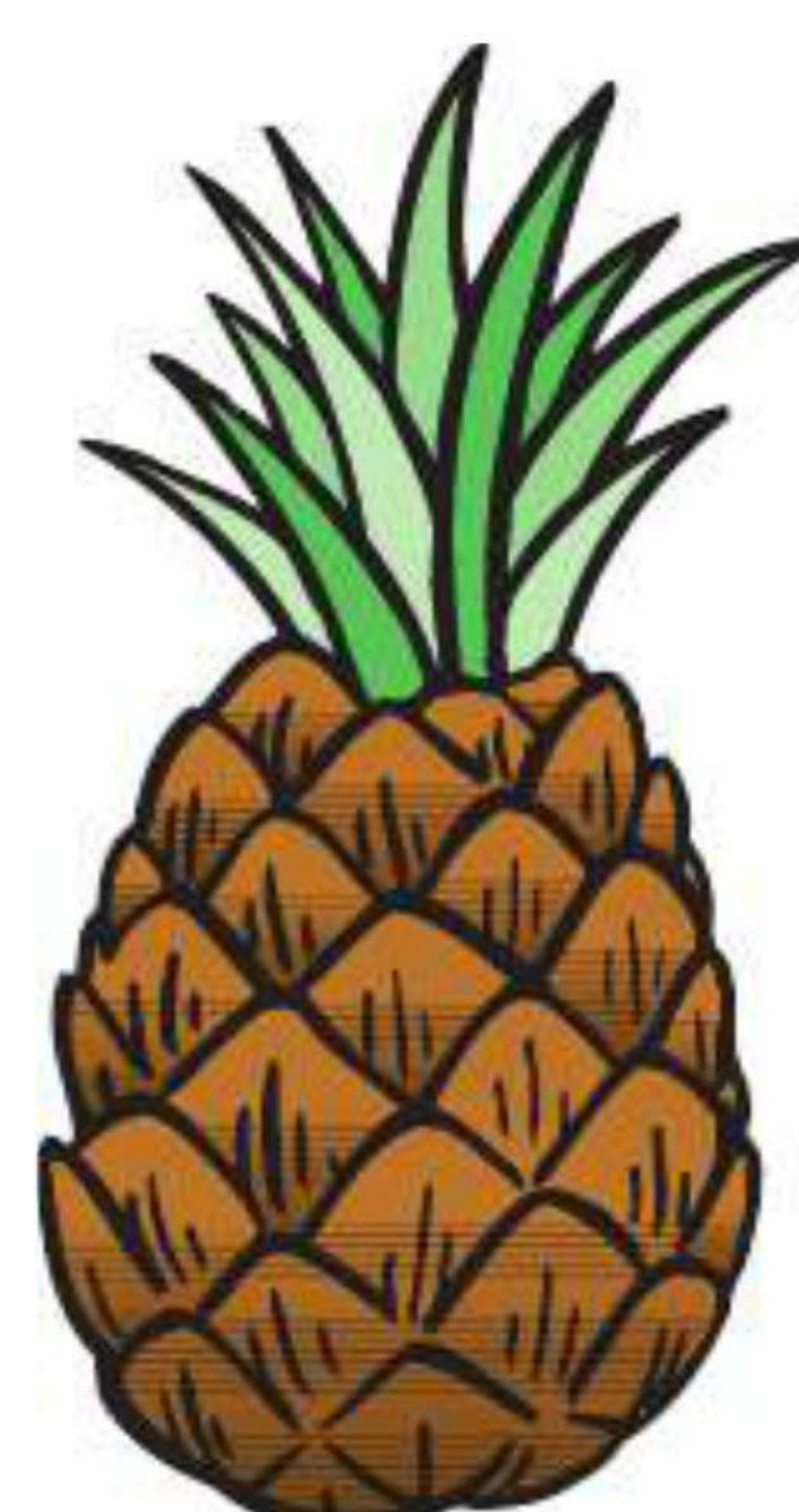
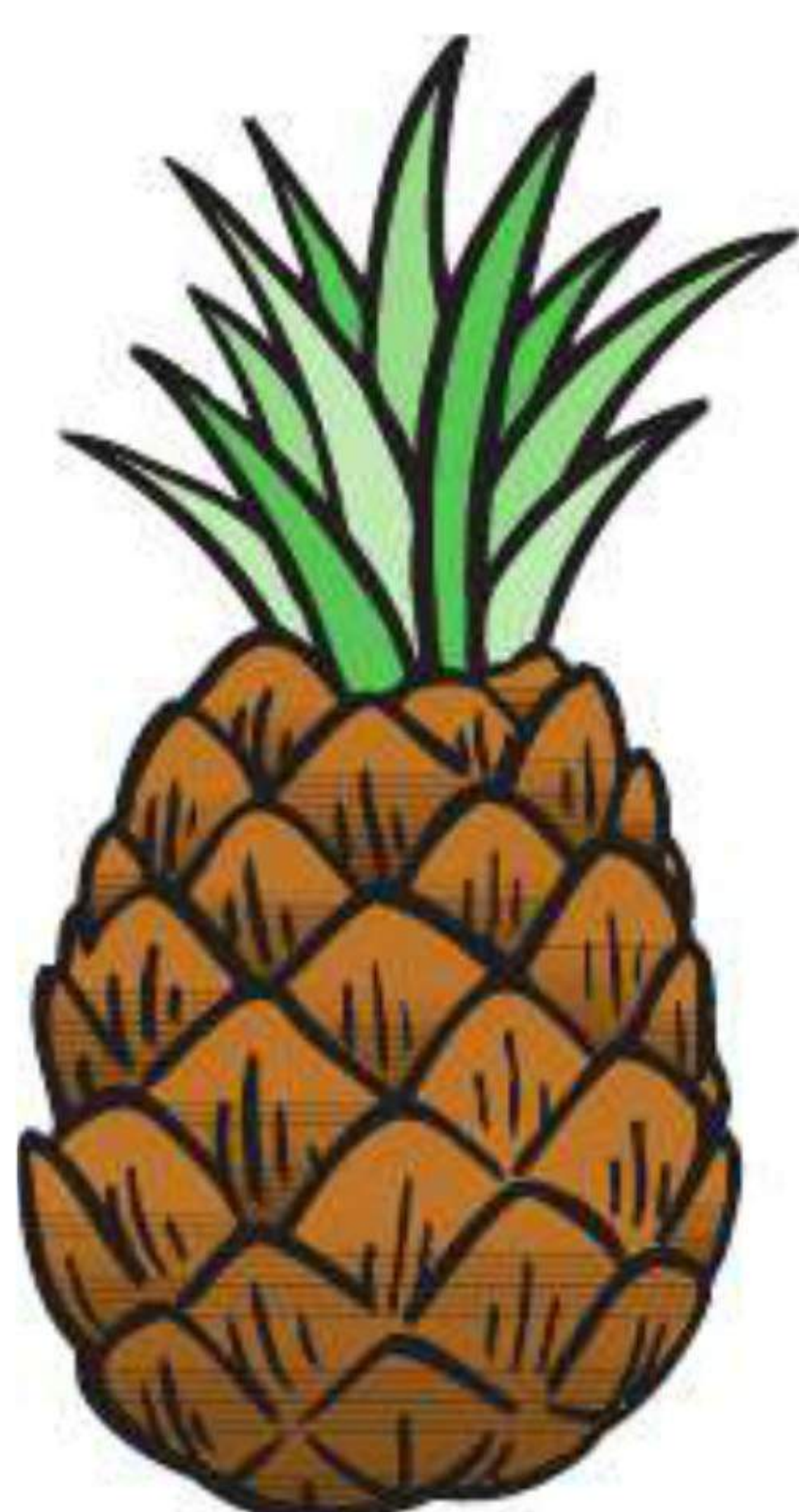
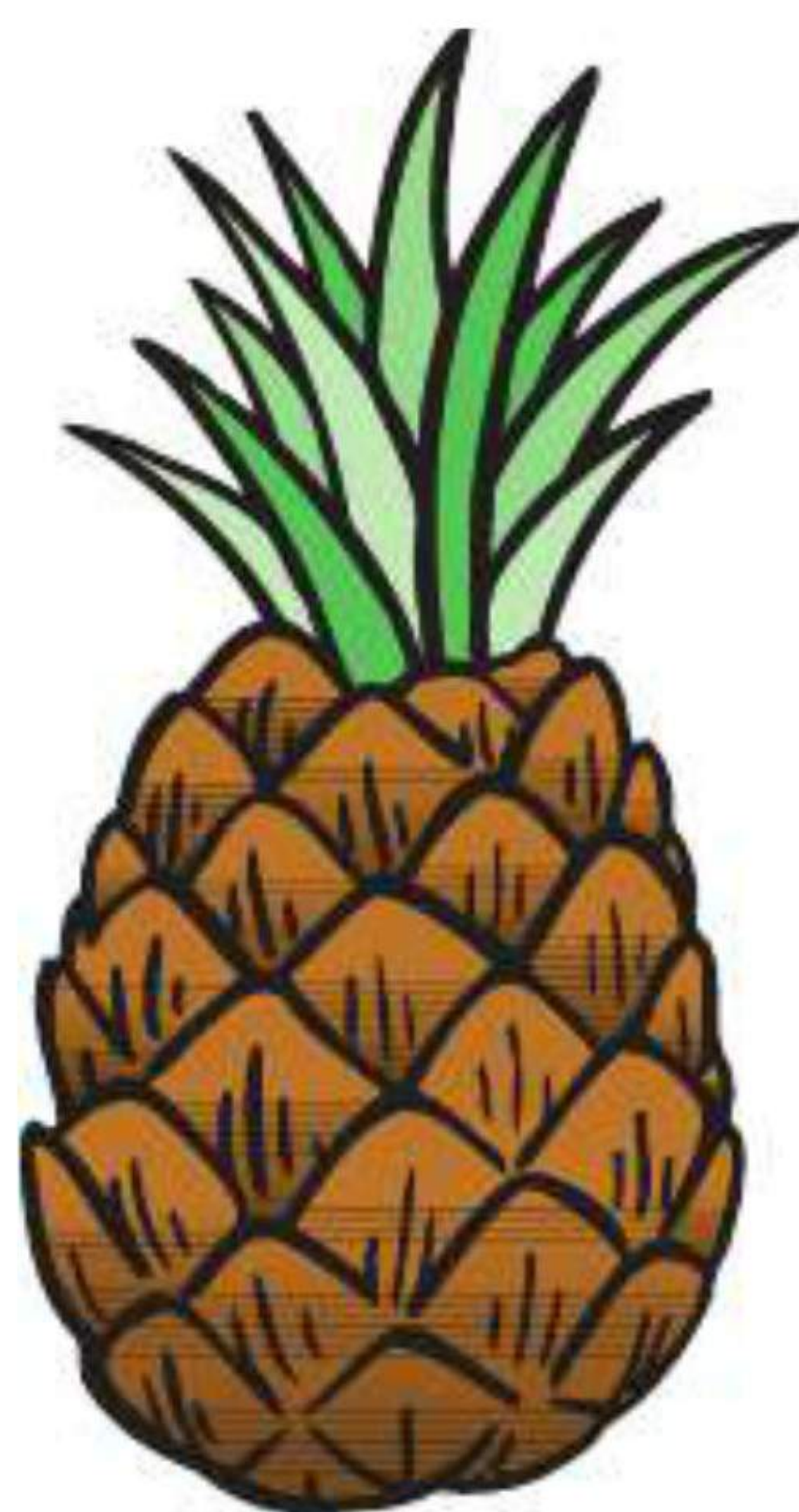
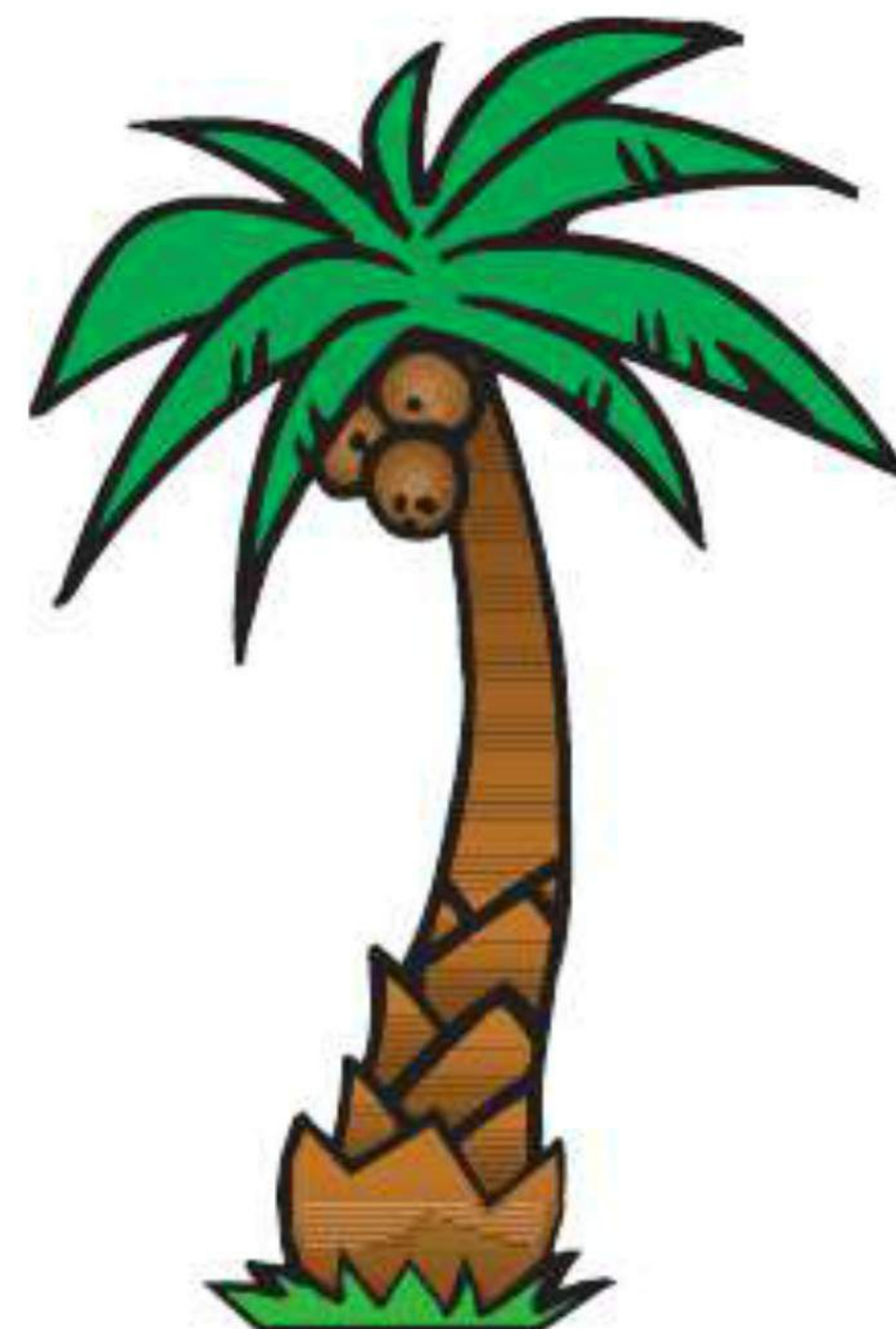

Name _____



Third

Directions: Circle the third thing in each row.

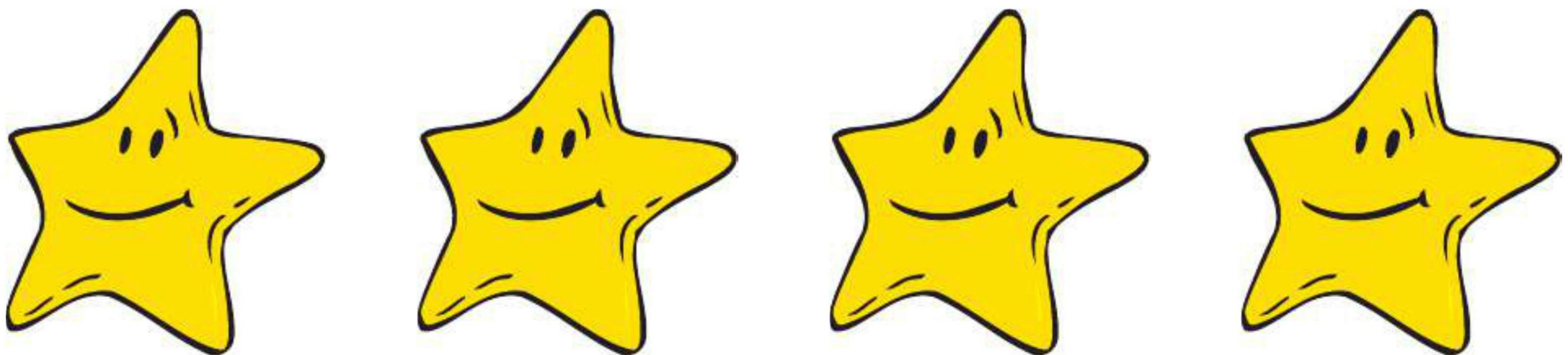
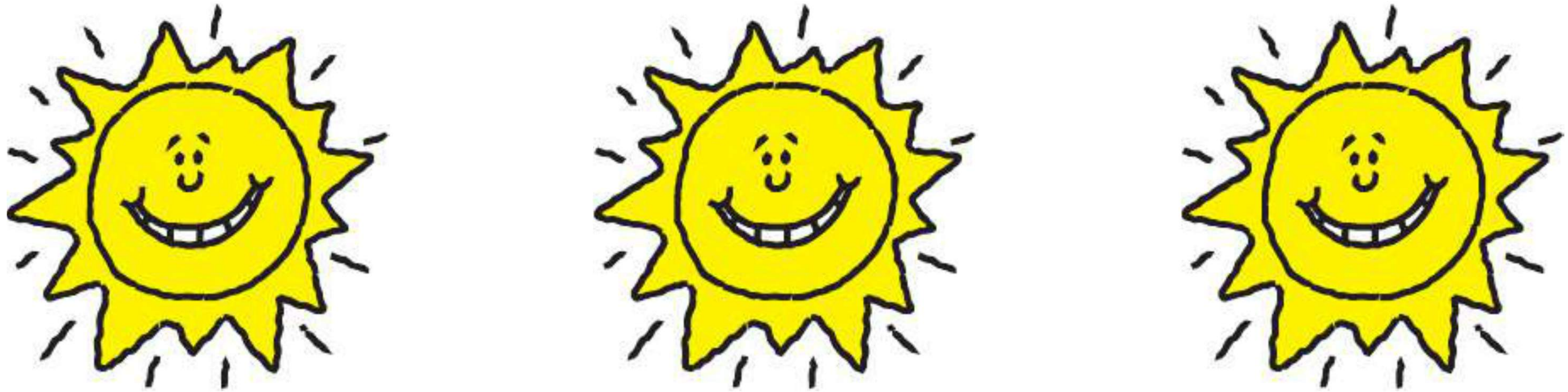
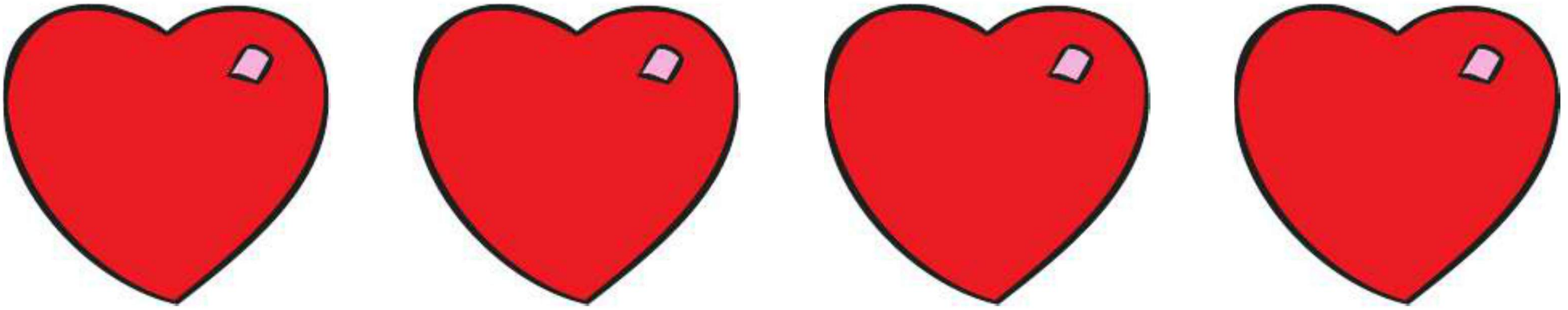



Fourth

Directions: Circle the fourth thing in each row.

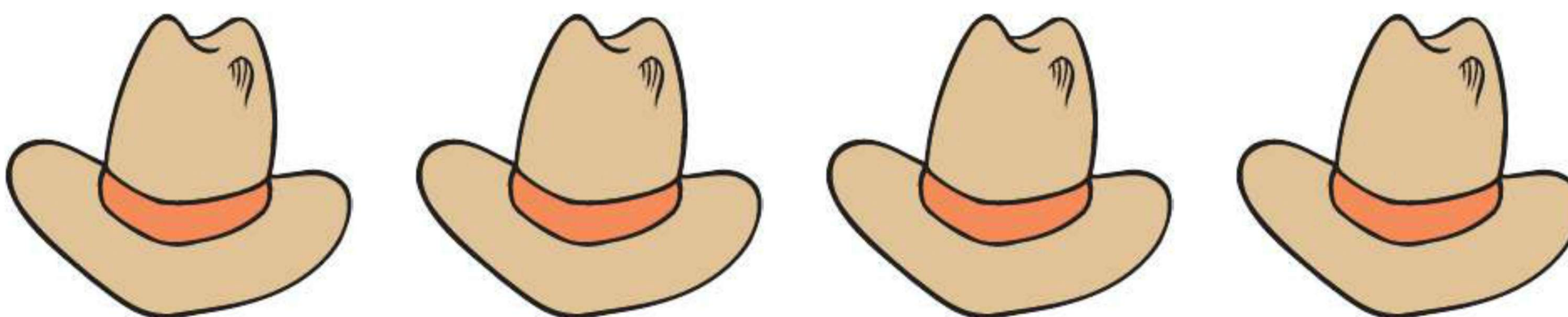
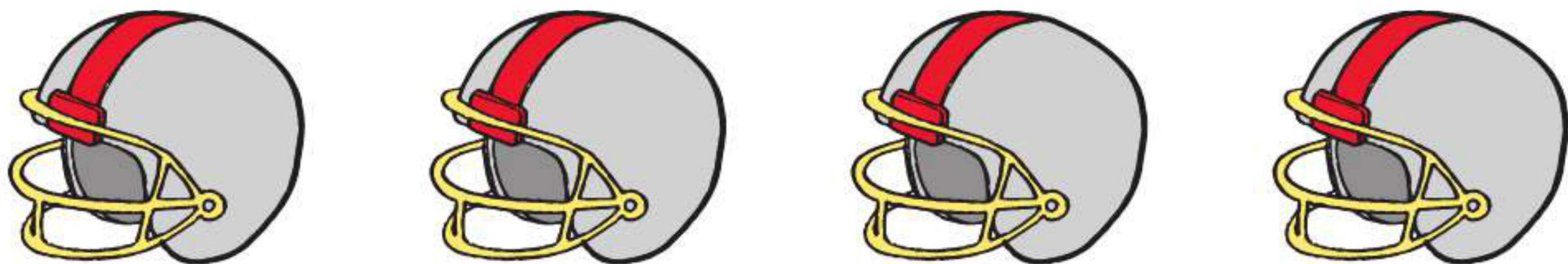

Name _____



Fifth

Directions: Circle the fifth thing in each row.

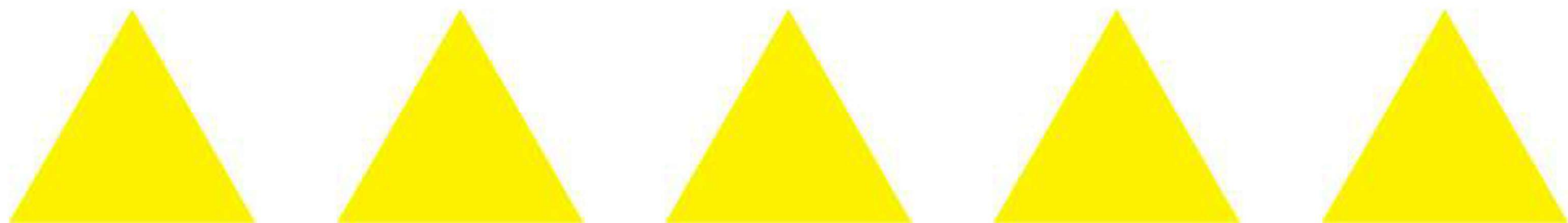
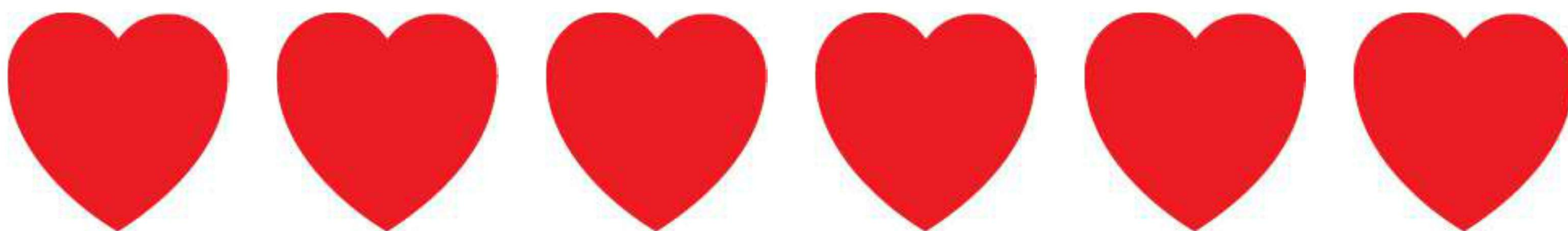
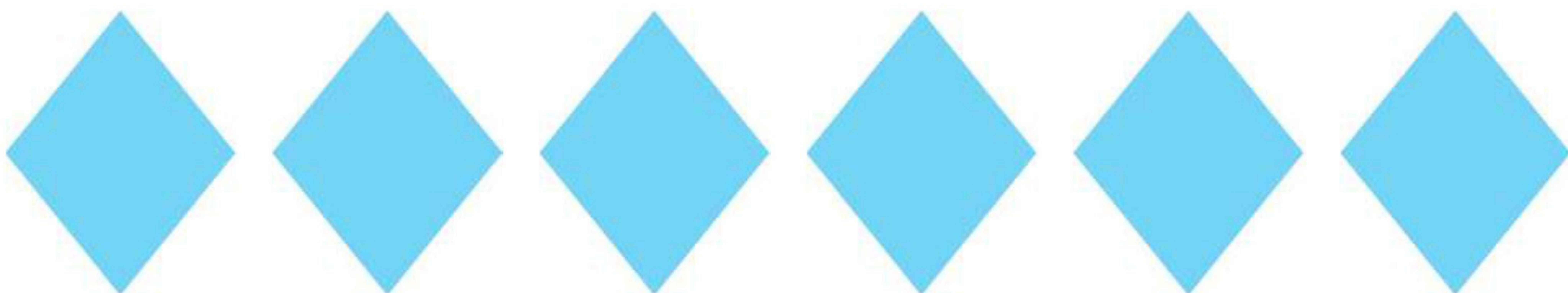
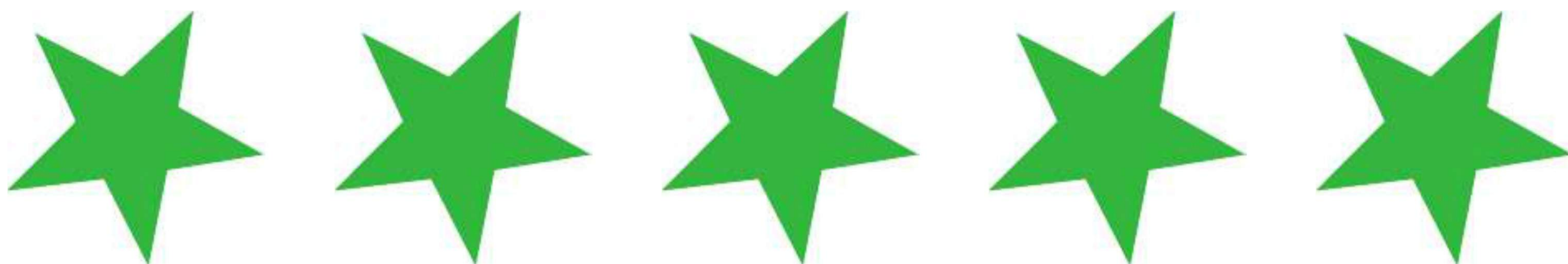



Ordinal Numbers

Directions: Color the first leaf **red**. Circle the third leaf.

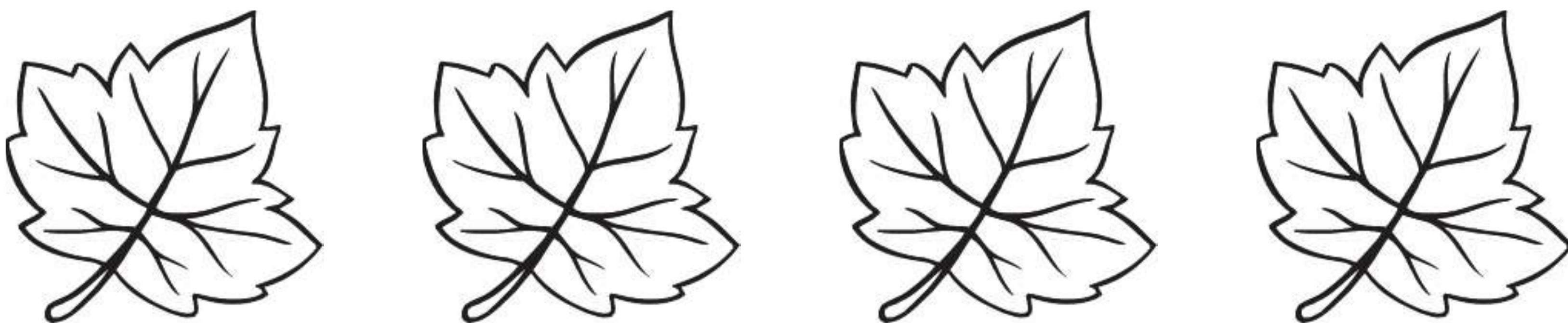

Directions: Color the fourth balloon **purple**. Draw a line under the second balloon.

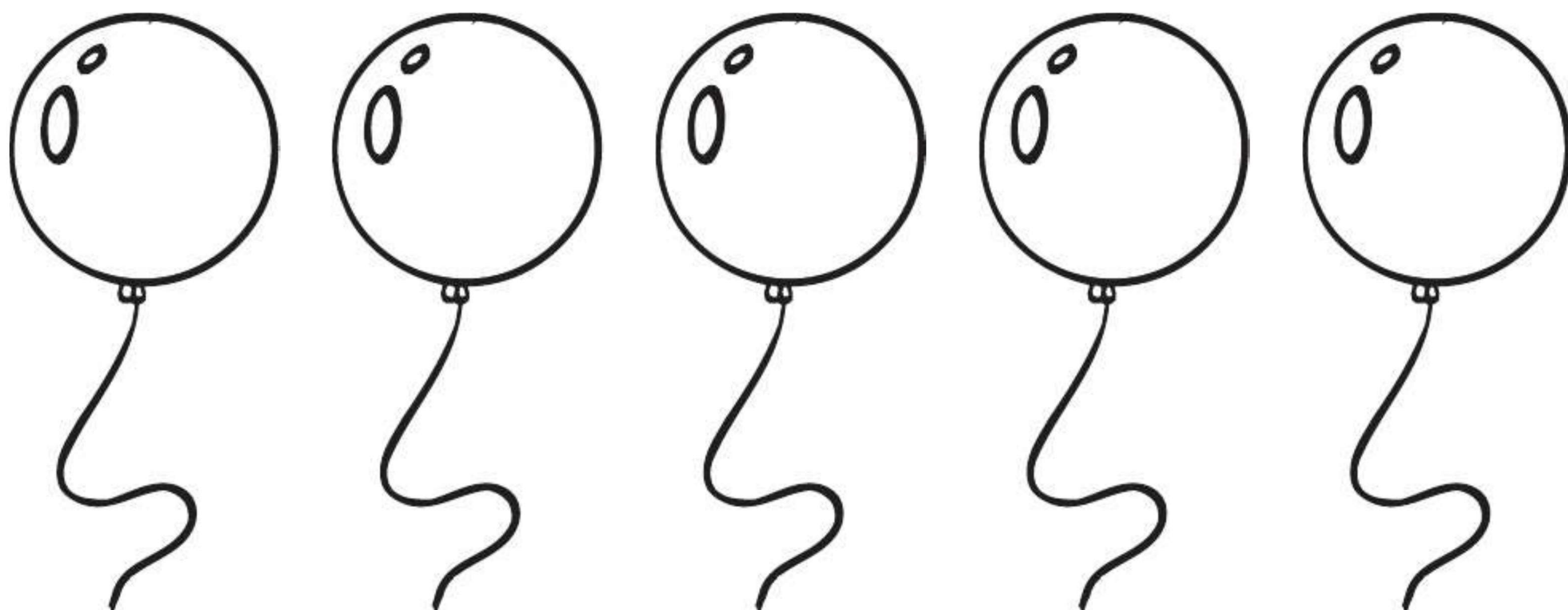



Same Number

Directions: Look at the first pond. Color the same number of ducks in the second pond.

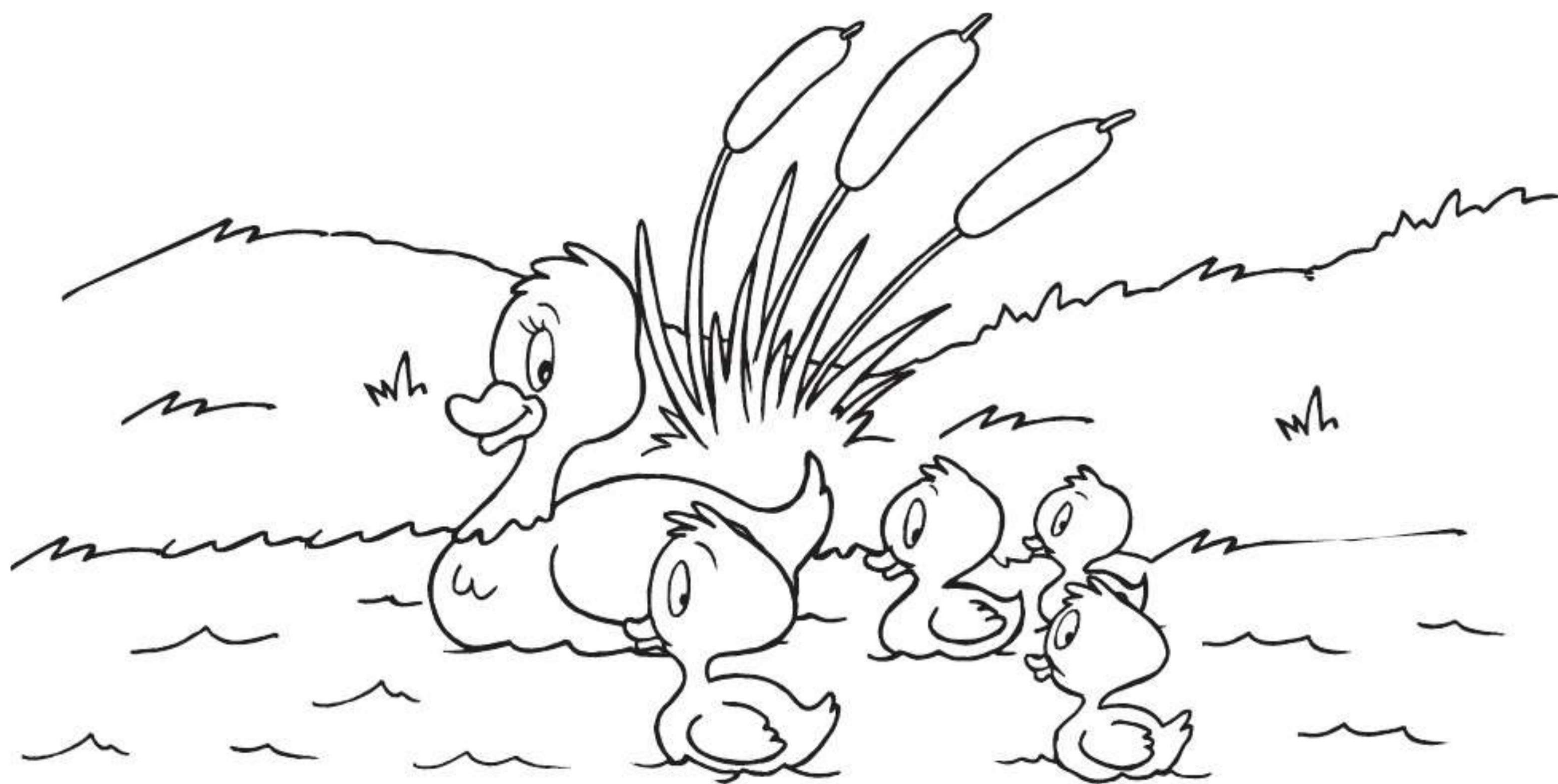
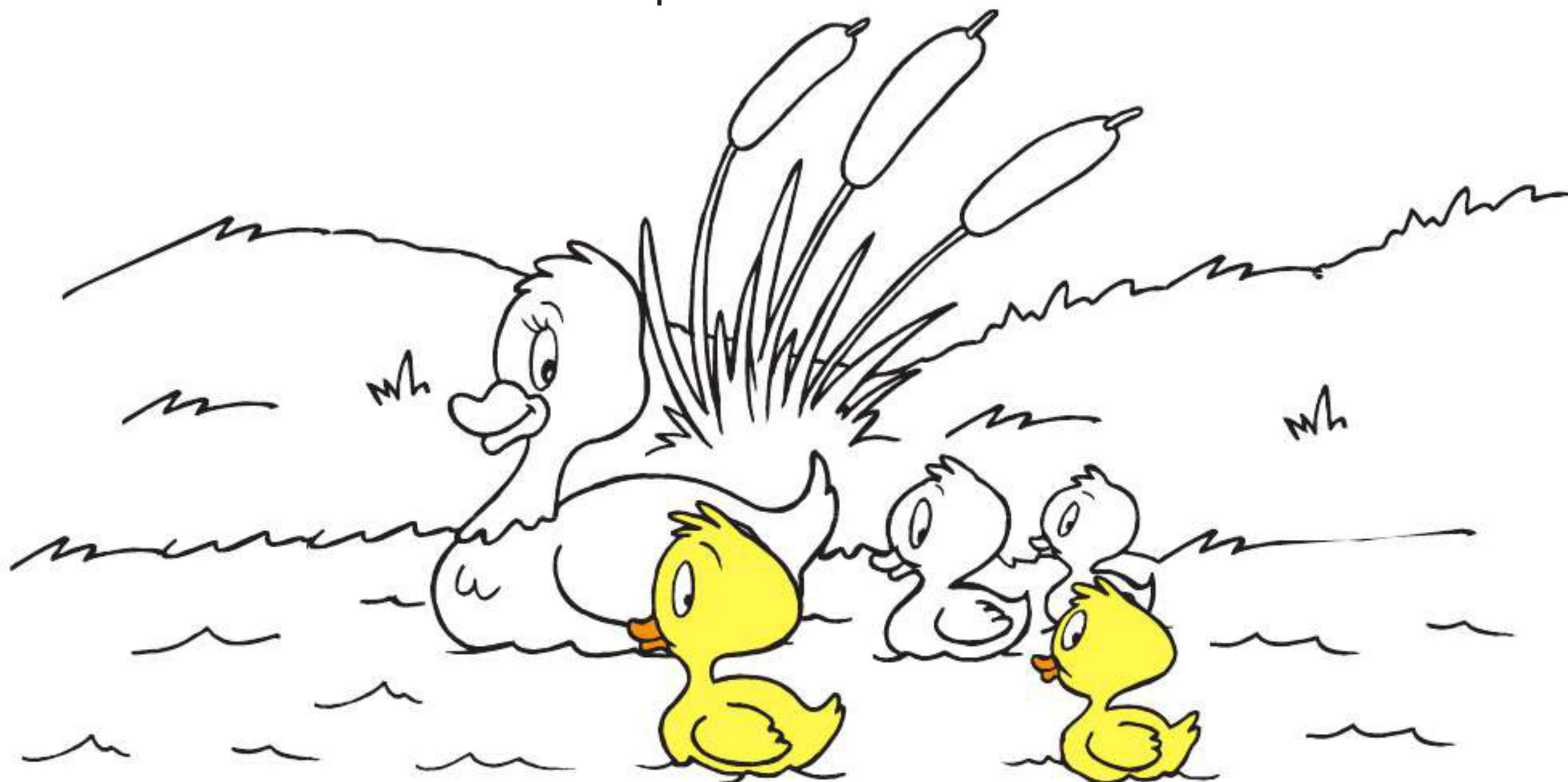



Same Number

Directions: Draw kites so that Kayla has the same number as Jayden.





One for Each

Directions: One shoe is correct for each person's job. Draw a line to match each person to the correct shoe.

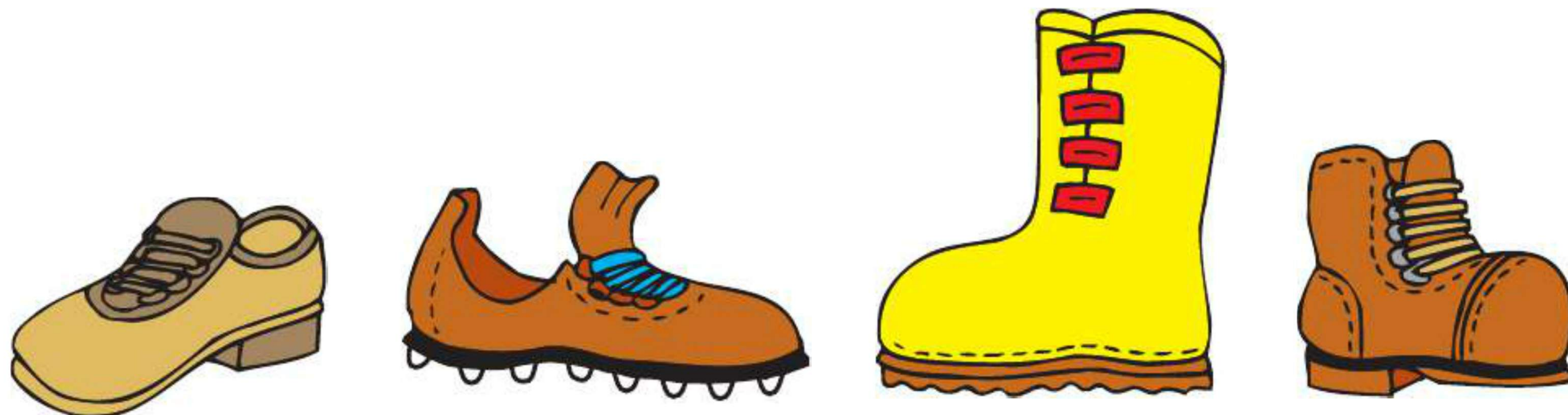
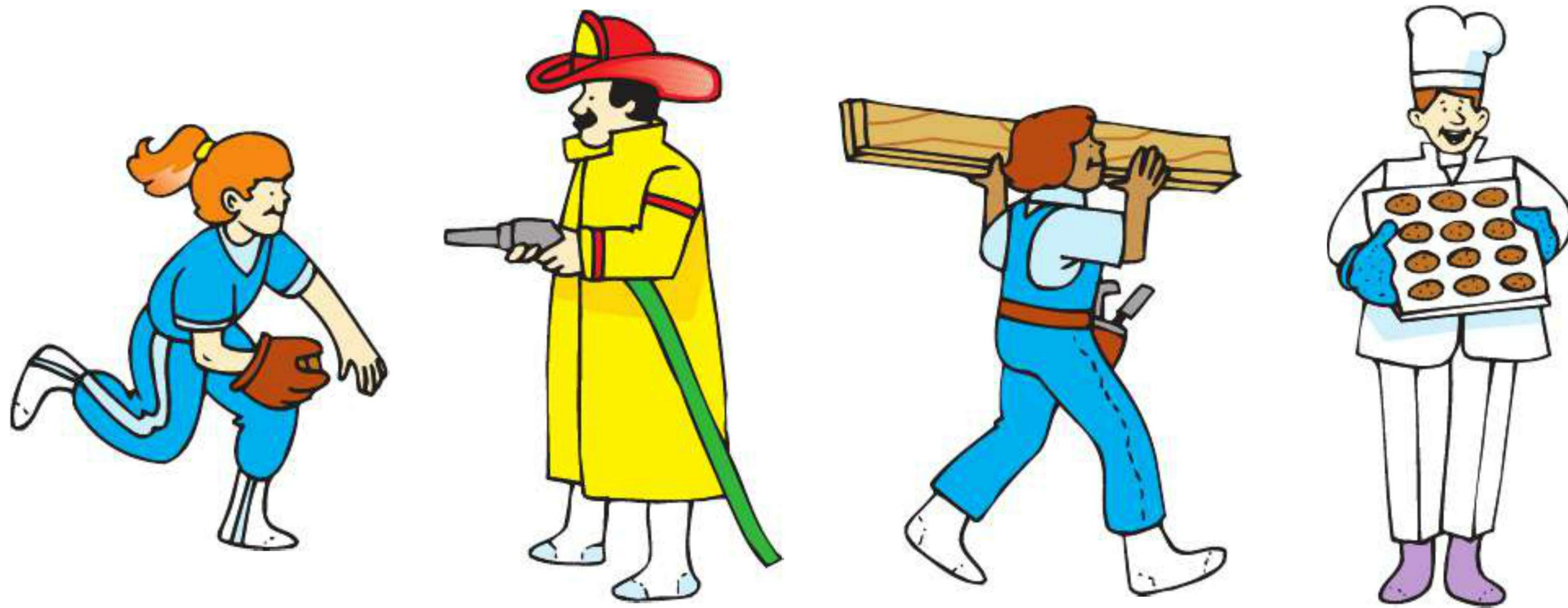



One for Each

Directions: Each animal needs a home. Draw a line to match each animal with a home.

The top section of the activity features three dogs on the left and three doghouses on the right. The dogs are colored brown, yellow, and dark brown. The doghouses are colored red, blue, and green. Each doghouse has a matching colored bowl of food in front of it. The bottom section features four cats on the left and four cat beds on the right. The cats are colored yellow, orange, grey, and brown. The cat beds are colored pink, light blue, light green, and purple.

Name _____



More

Directions: Color the group in each box that has more.

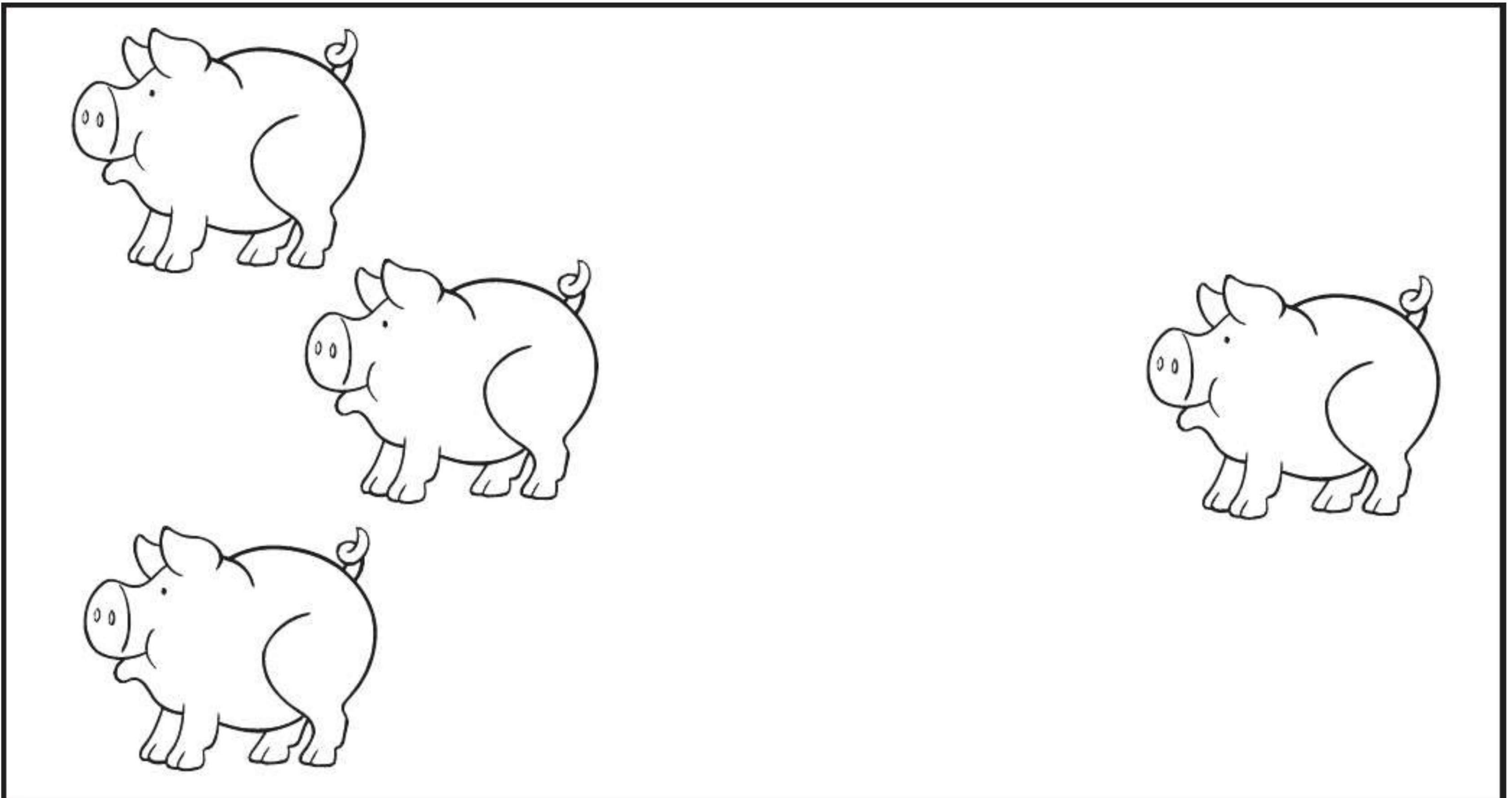



More

Directions: Circle the group in each box that has more.

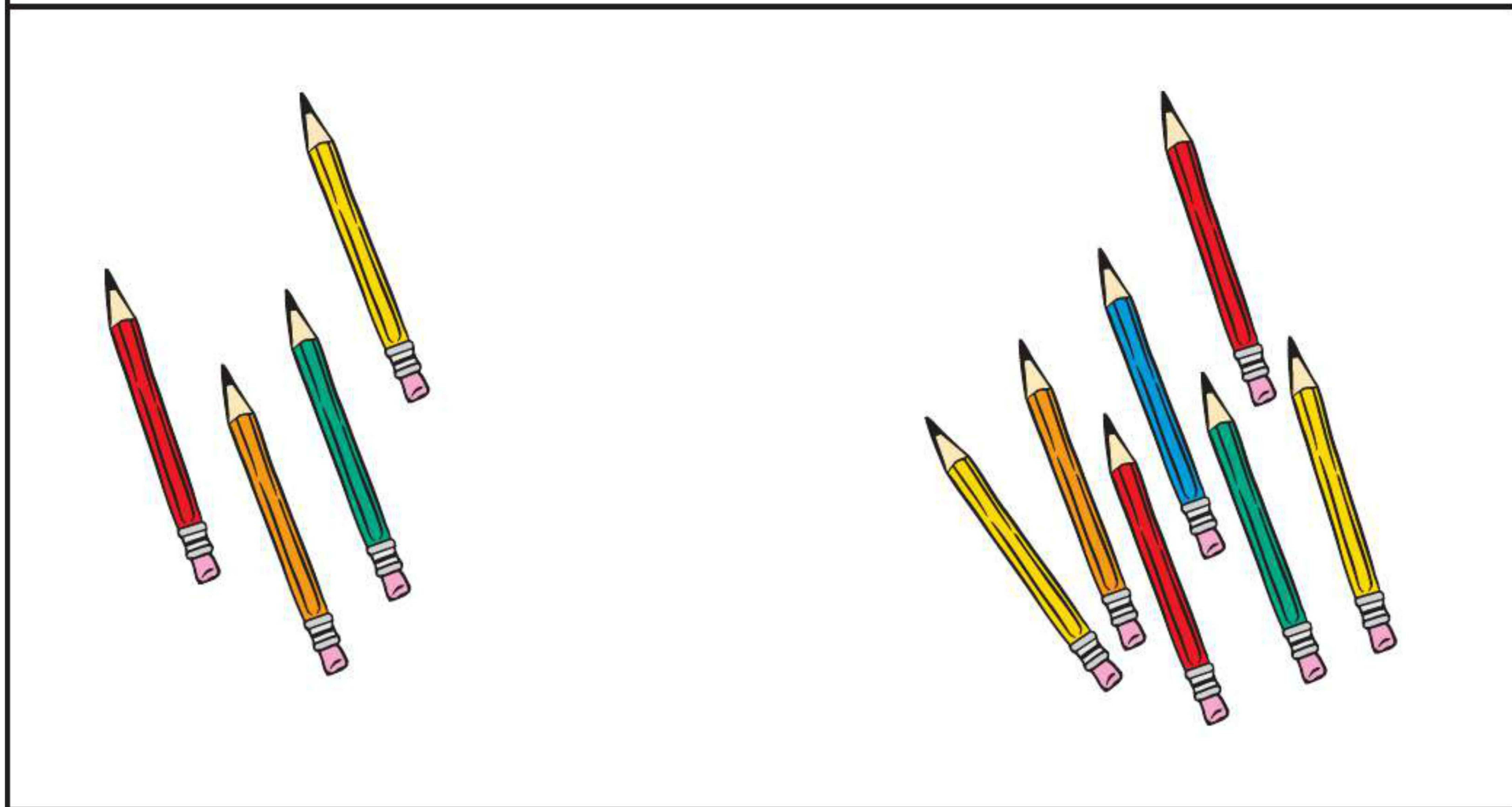
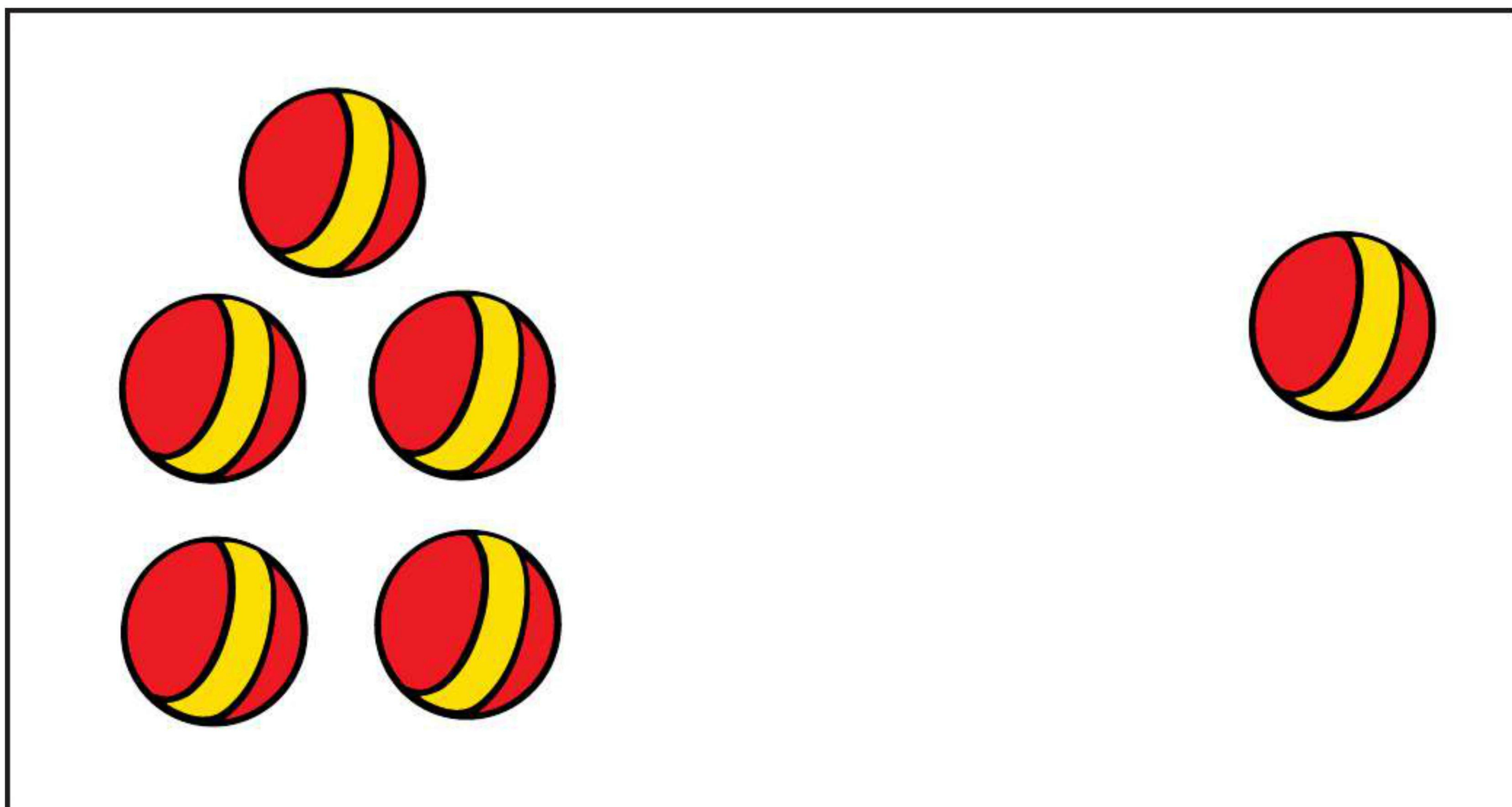

Name _____



Fewer

Directions: Color the group in each box that has fewer.

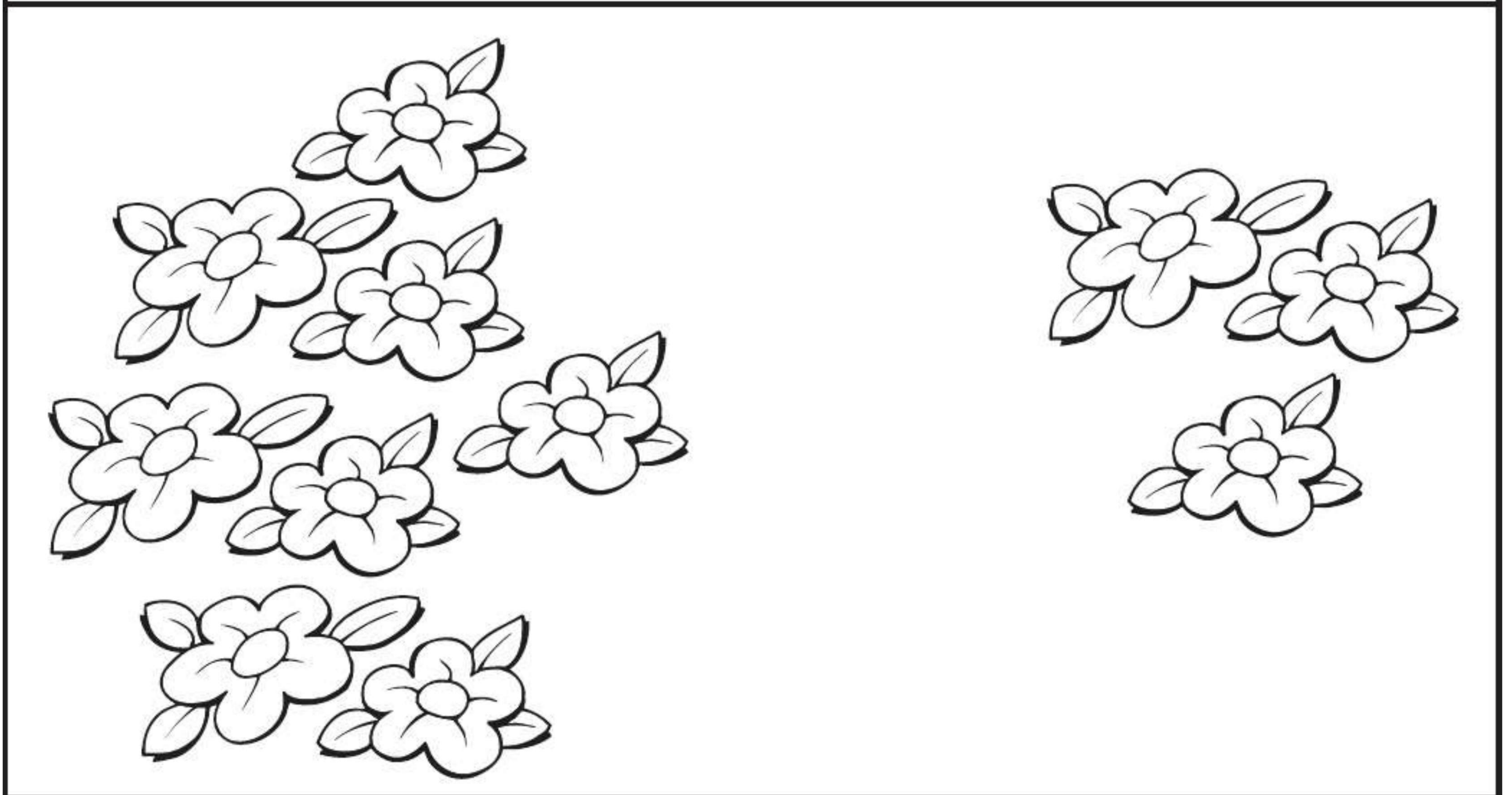
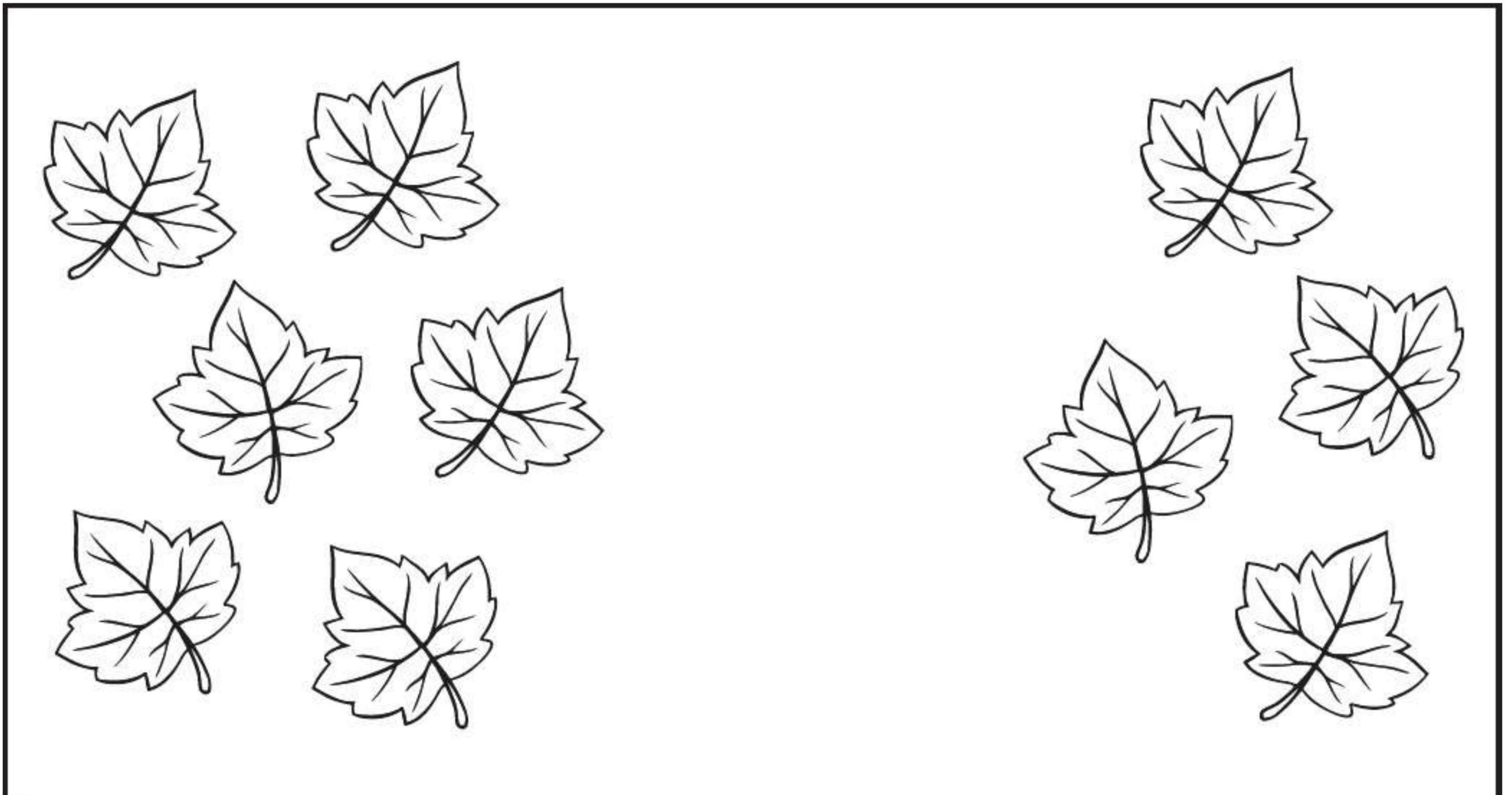



Fewer

Directions: Circle the group in each box that has fewer.

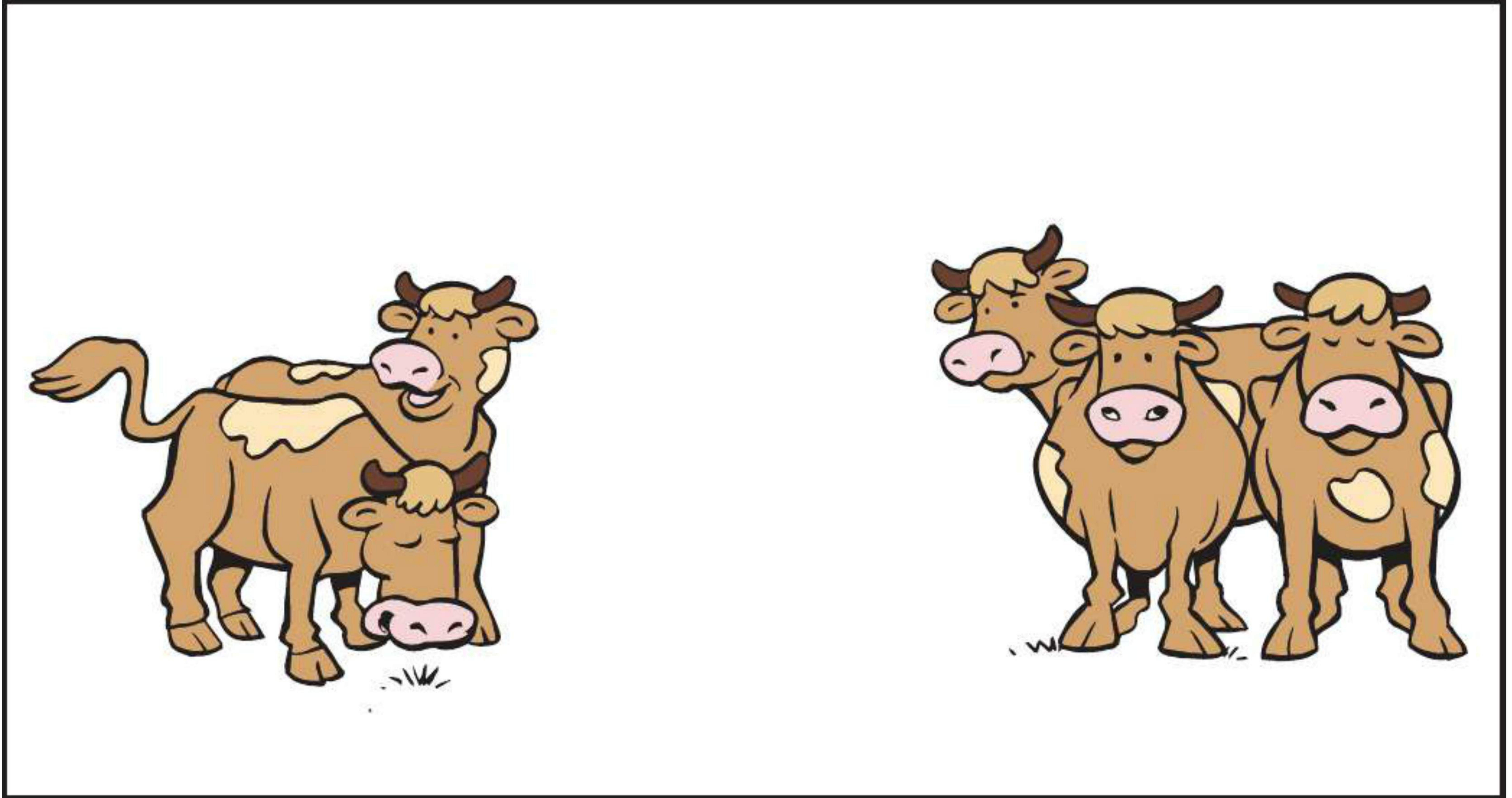
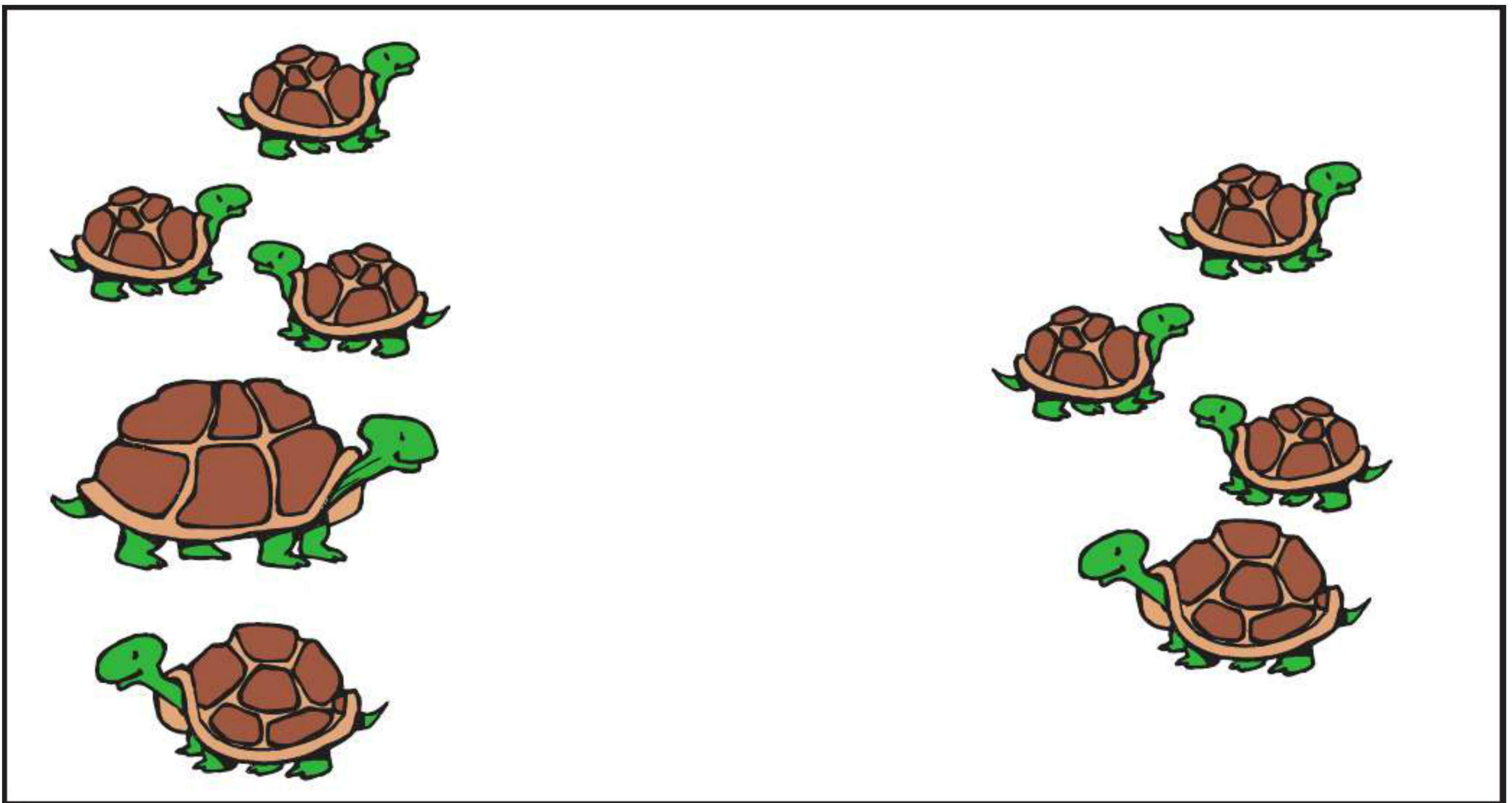

Name _____



Zero 0

Directions: Trace and write the number 0. Then, draw an X on the tanks with zero fish.

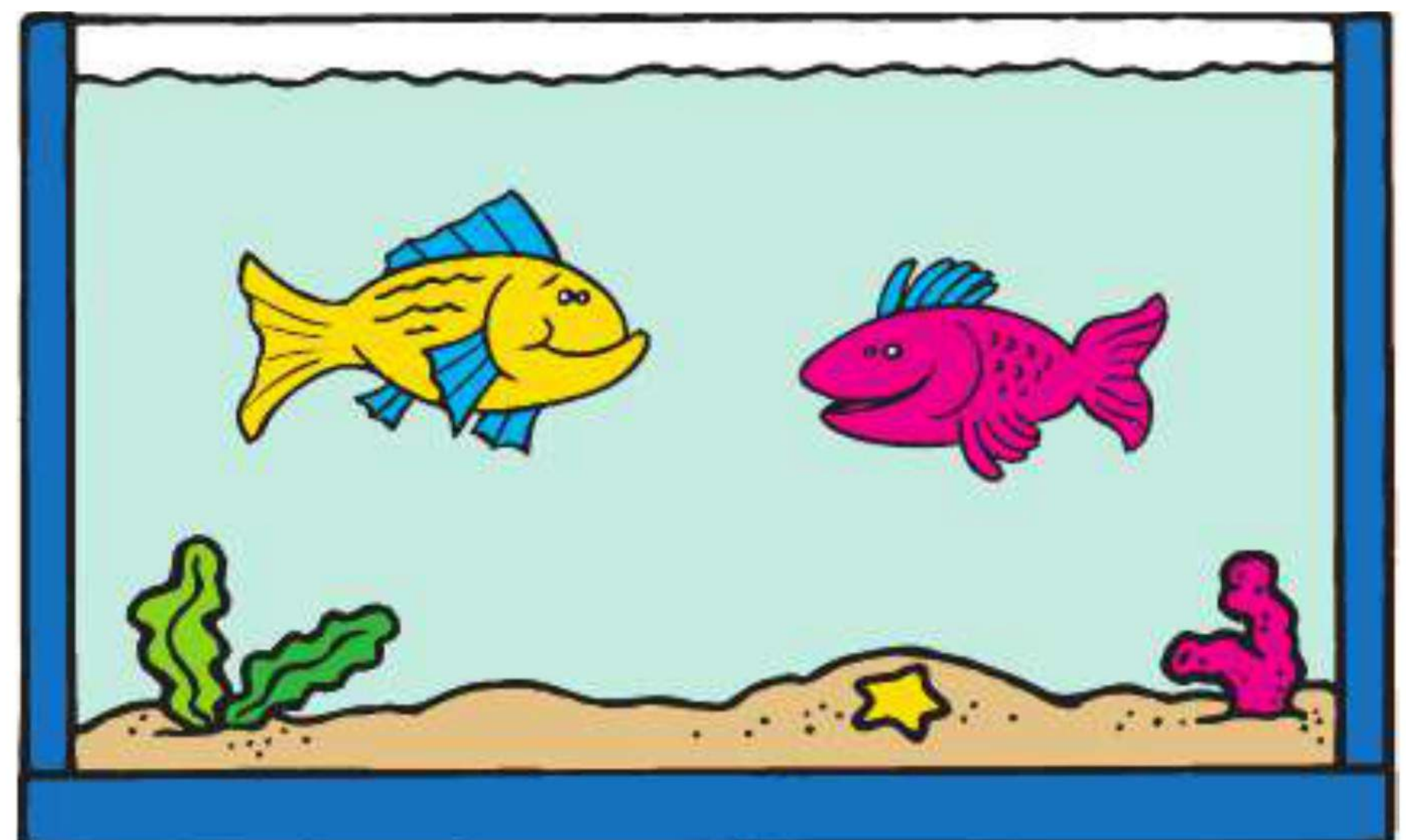
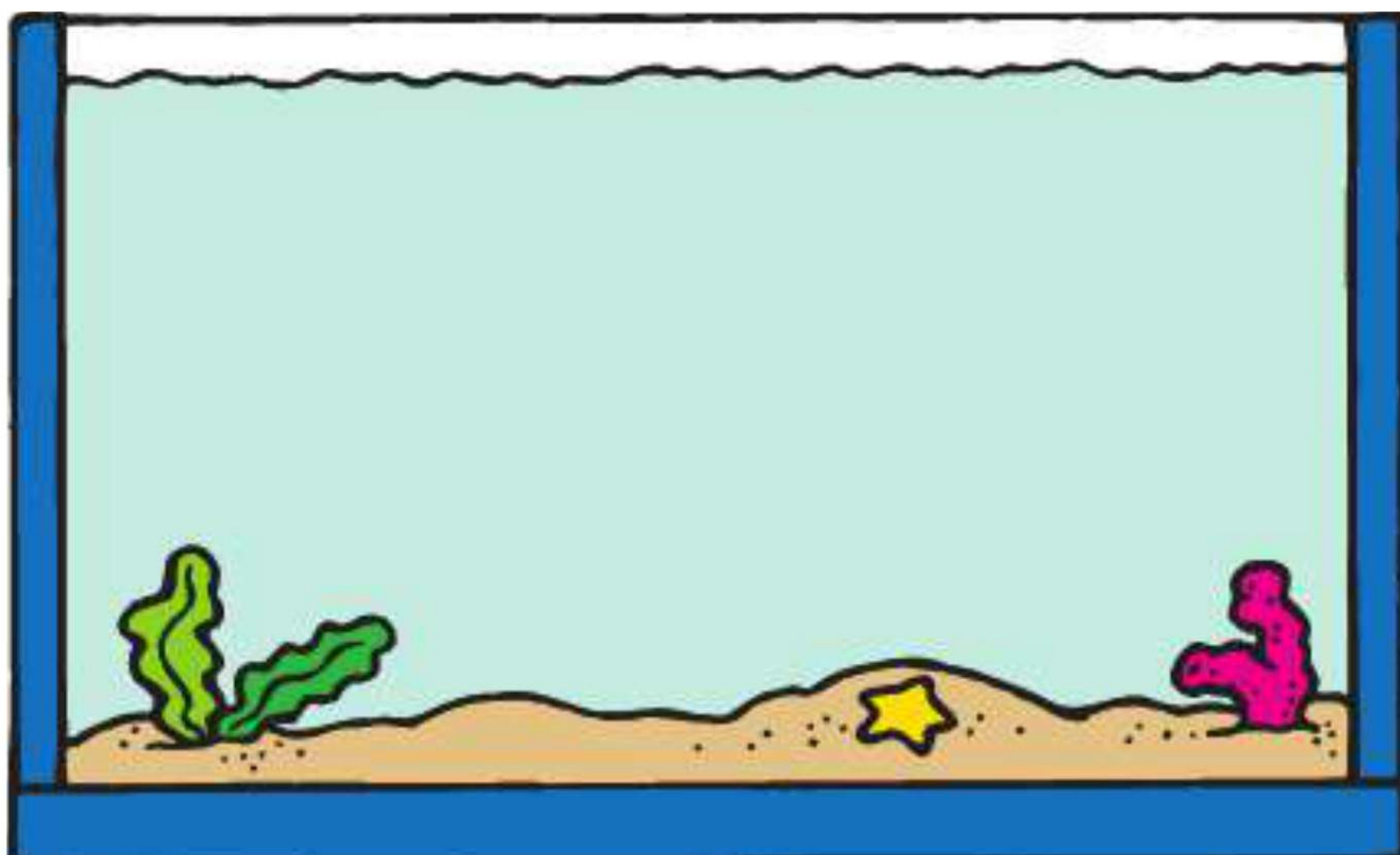
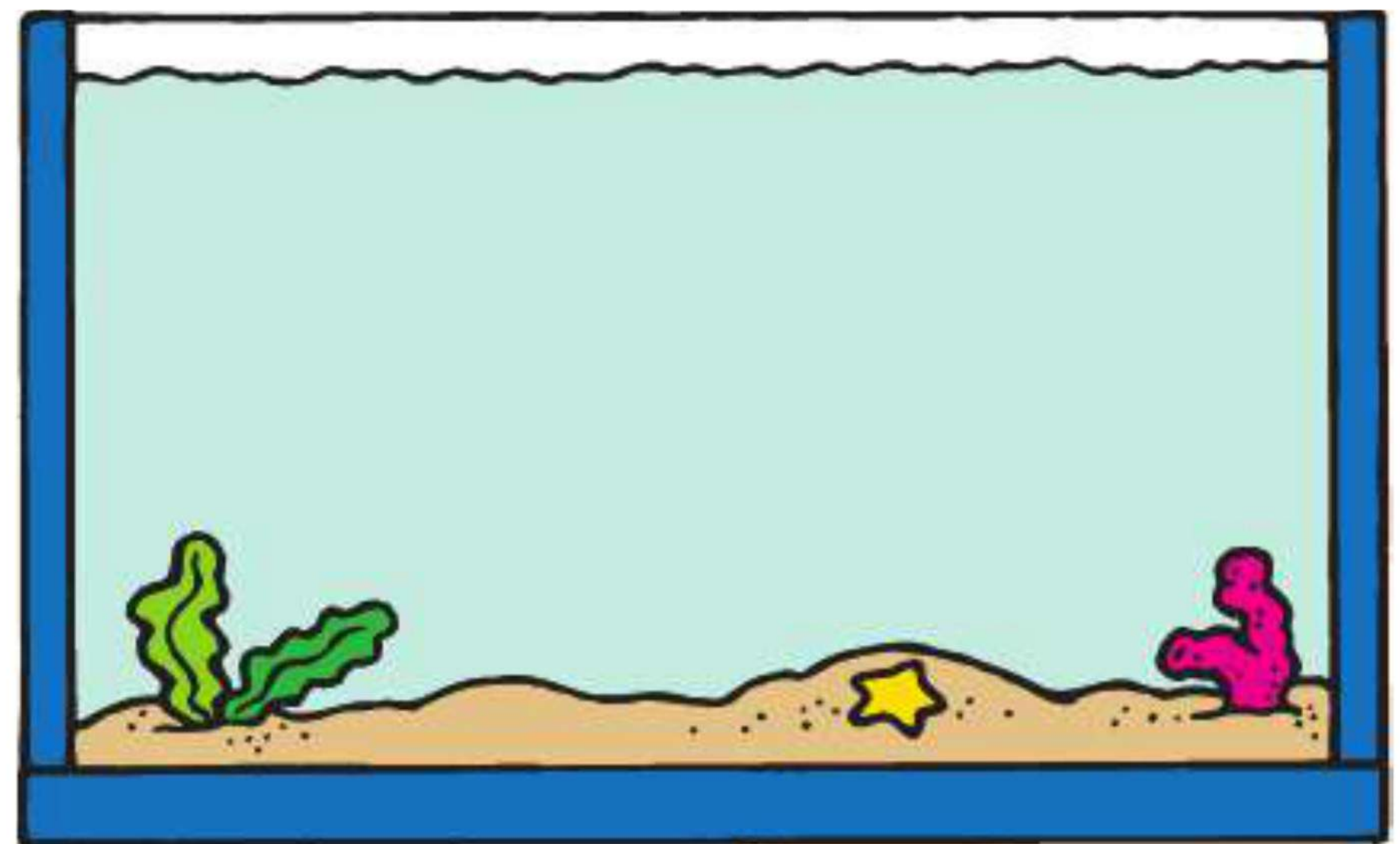
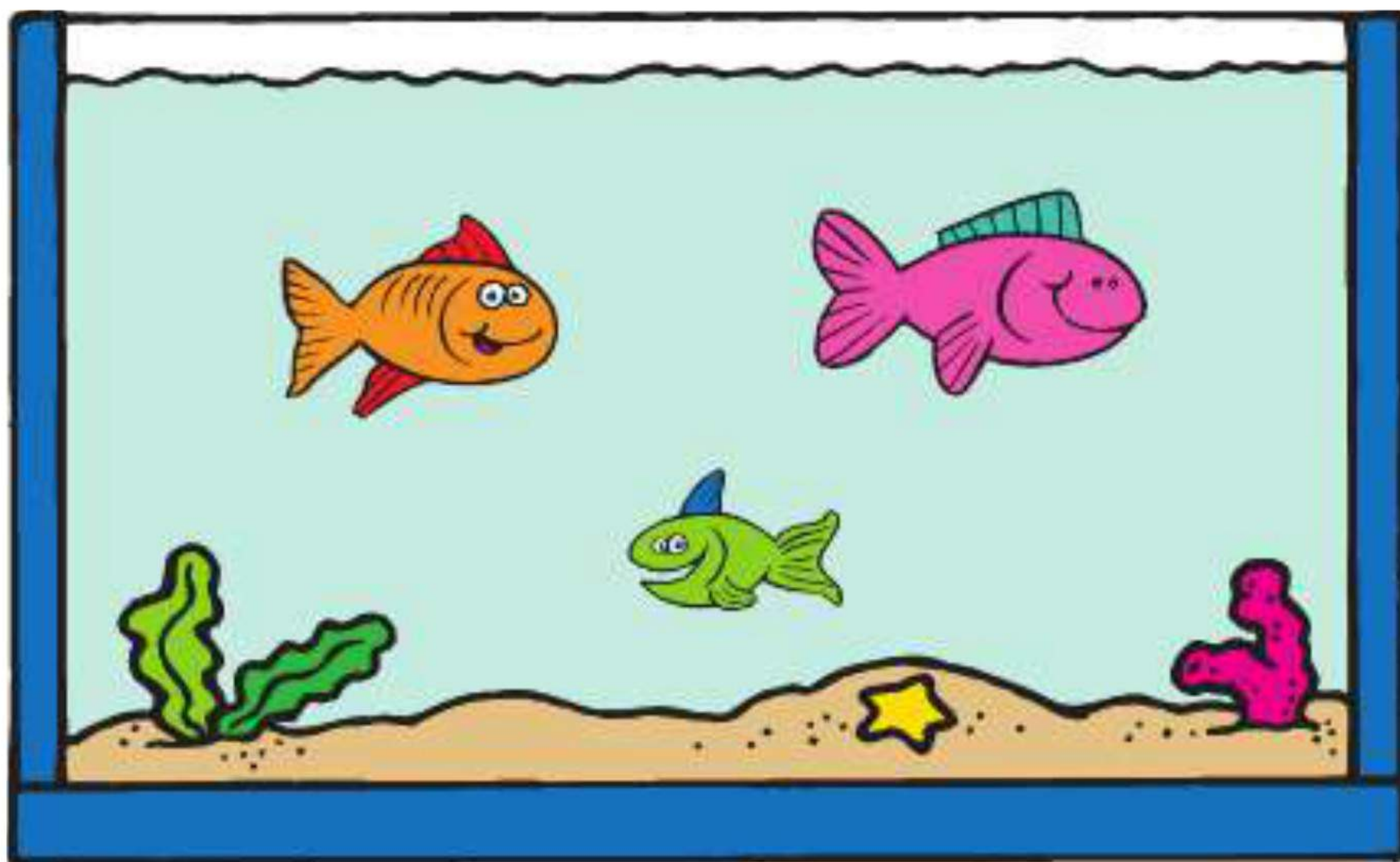
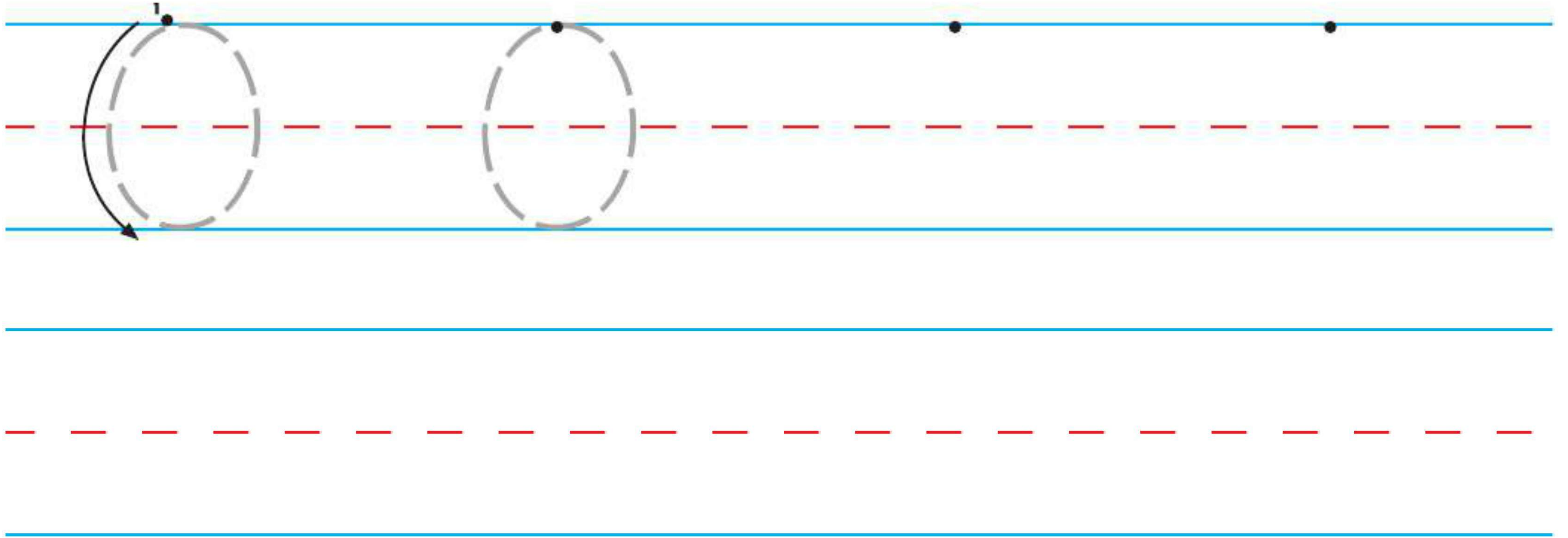



Zero 0

Directions: Trace and write the word **zero**. Then, circle the number of fish in each tank.

Tracing practice for the word "zero". The first row shows the word "zero" with numbered arrows indicating stroke order: 'z' (1: horizontal right, 2: diagonal down-right, 3: horizontal right), 'e' (1: horizontal right, 2: counter-clockwise curve), 'r' (1: vertical down, 2: counter-clockwise curve), and 'o' (1: counter-clockwise curve). The second row shows the word "zero" in a dashed font for tracing. Below are two blank sets of handwriting lines (top dashed red, middle solid blue, bottom dashed red).

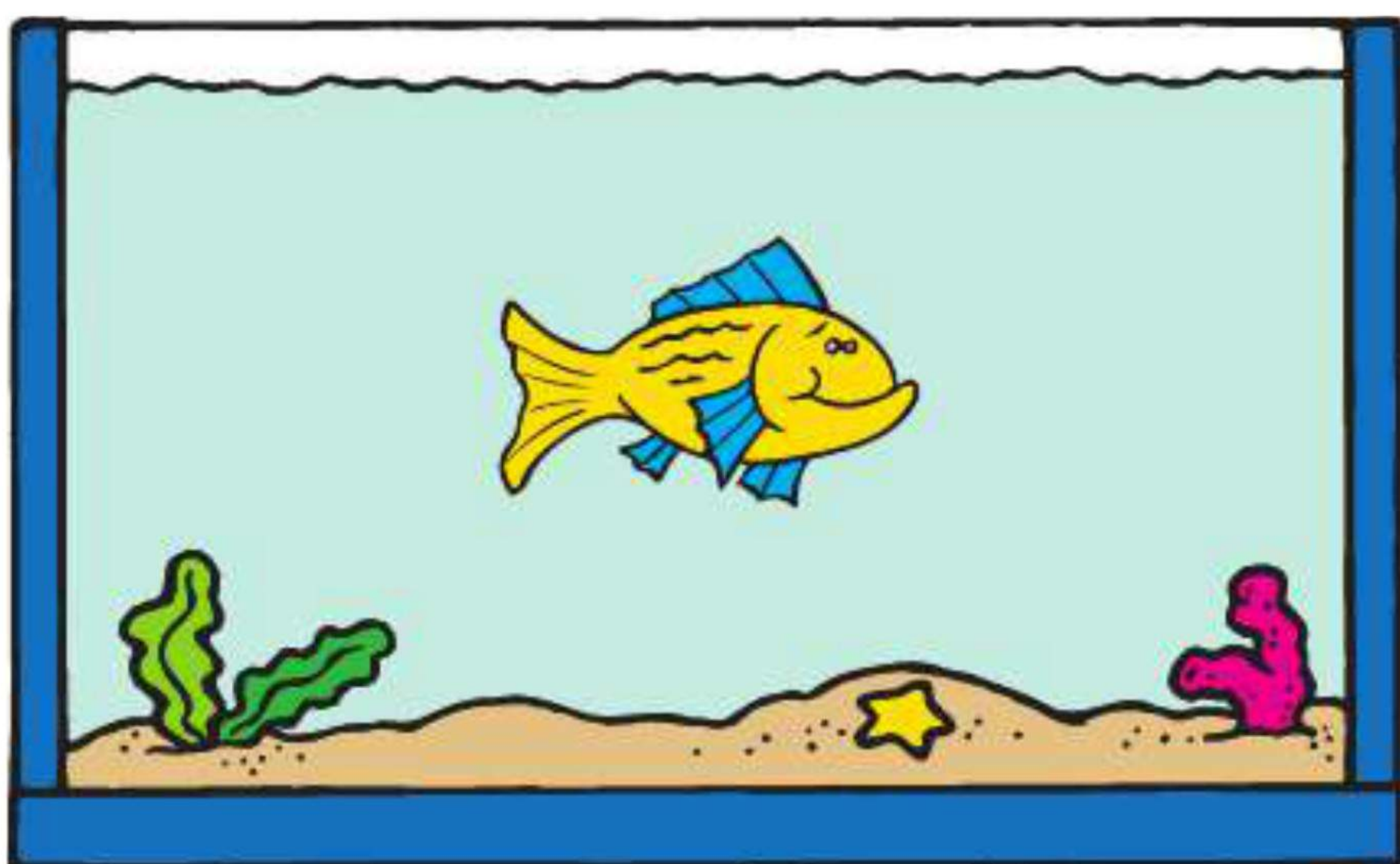

0 1 3

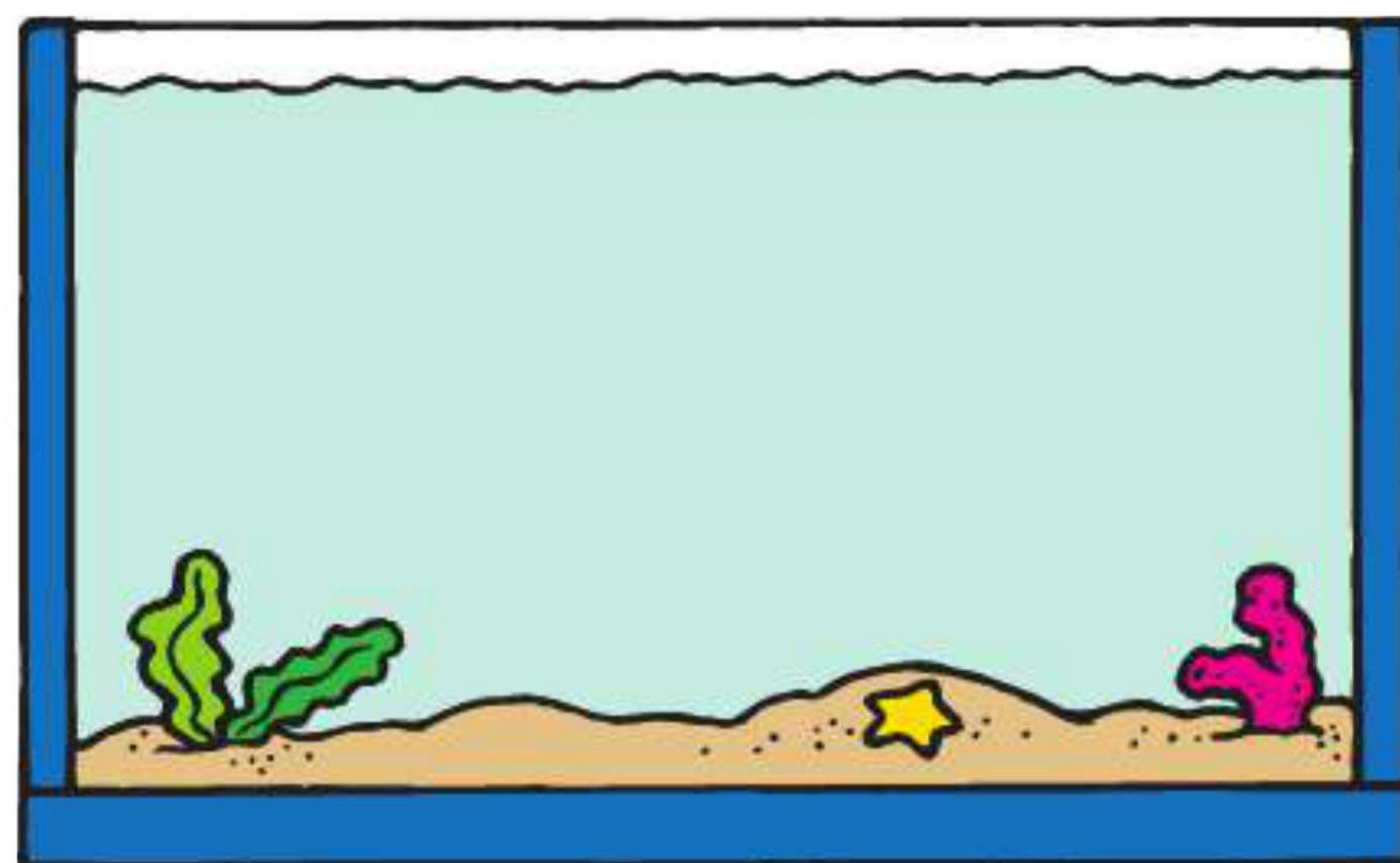

0 1 2

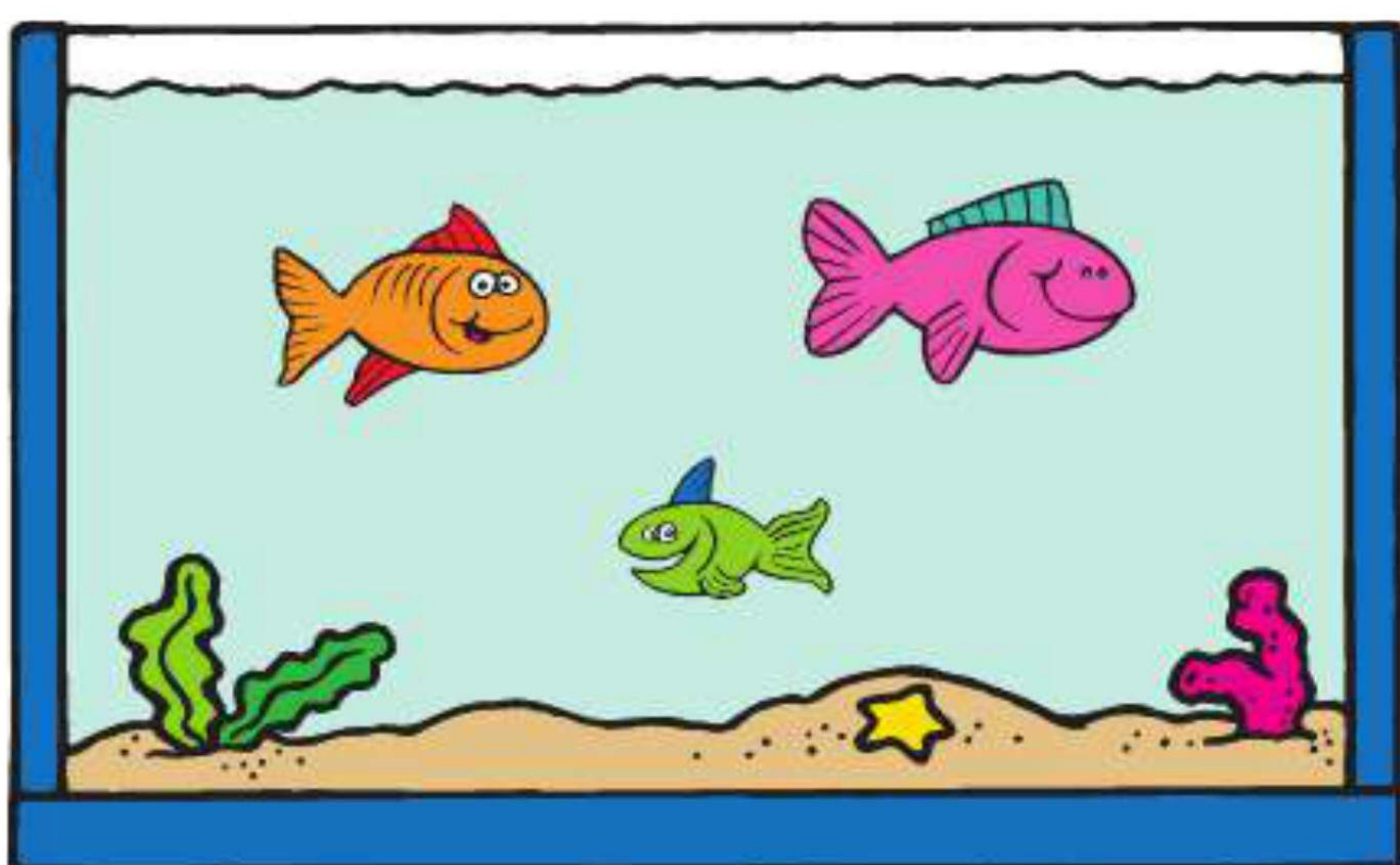

3 4 5

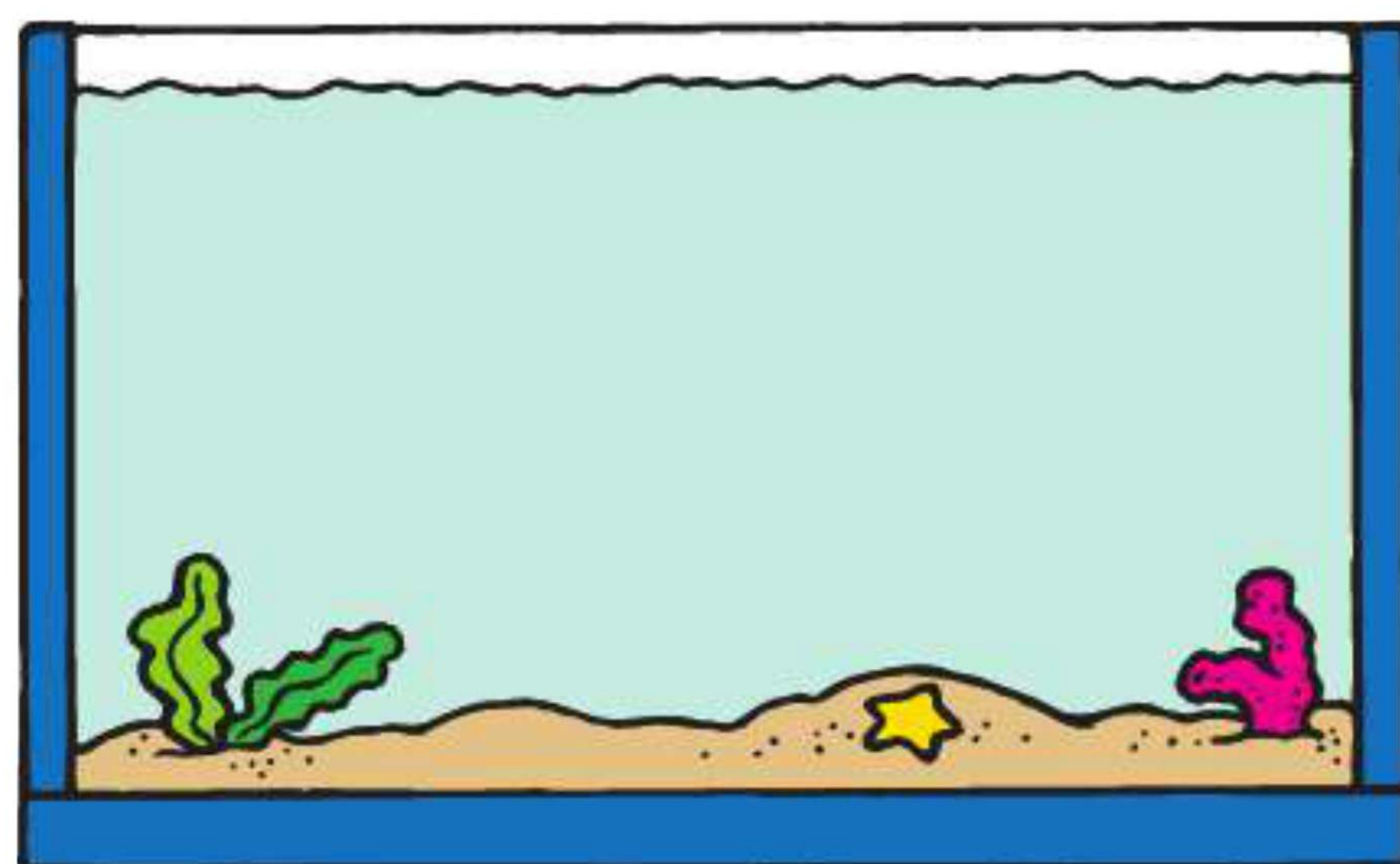

0 1 2

Name _____



One and Two 1, 2

Directions: Trace and write the numbers 1 and 2. Then, count and write the correct number.

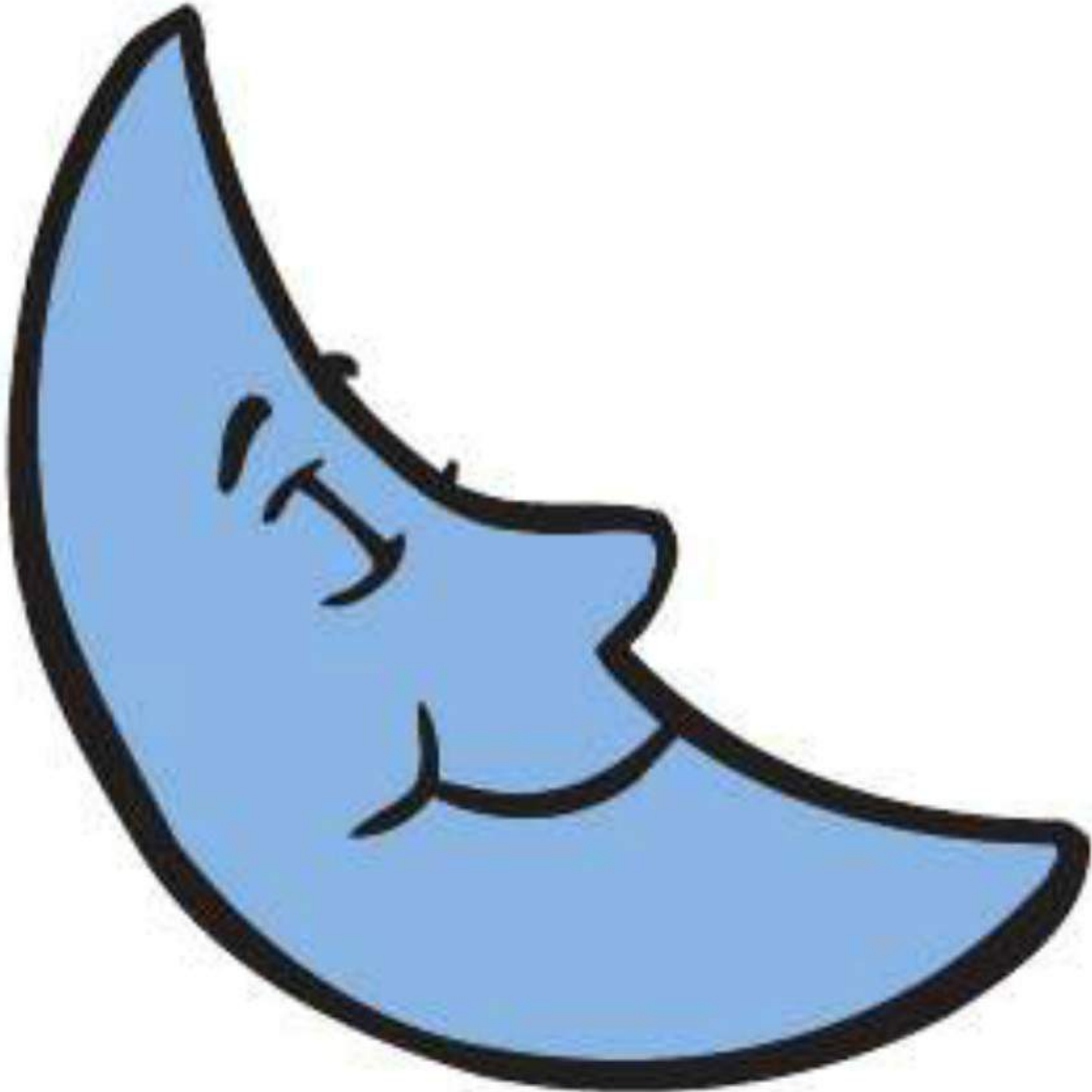
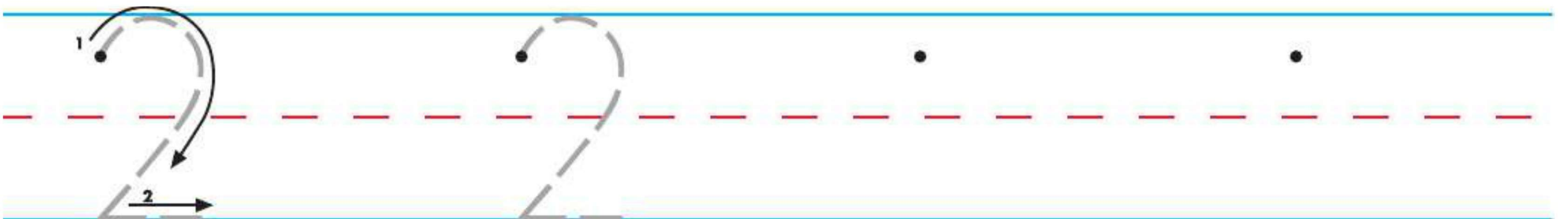
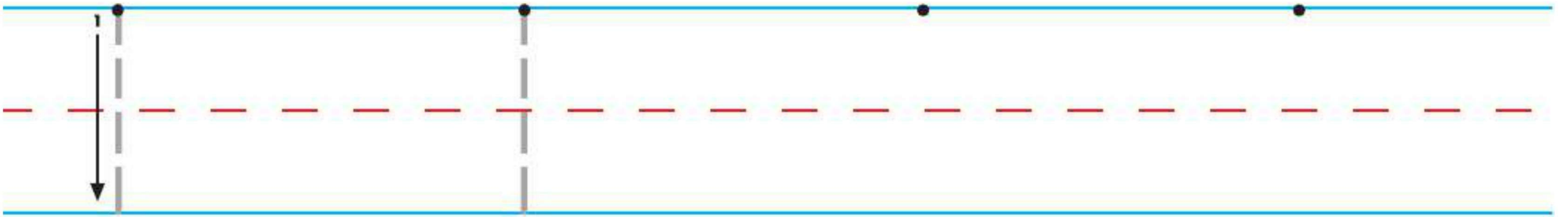

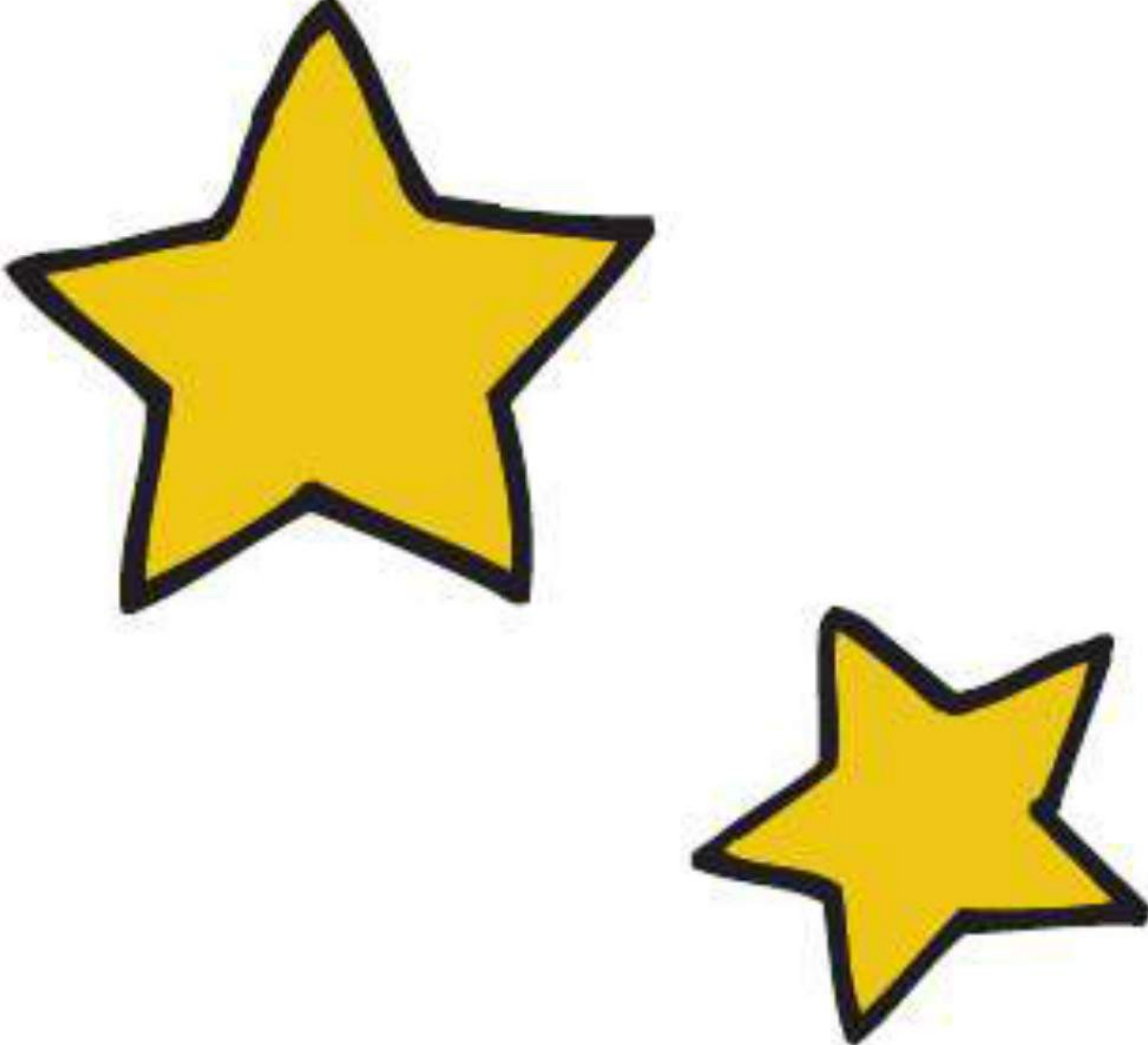



One and Two

Directions: Count and write the number in each box. Circle the groups of one. Color the groups of two.

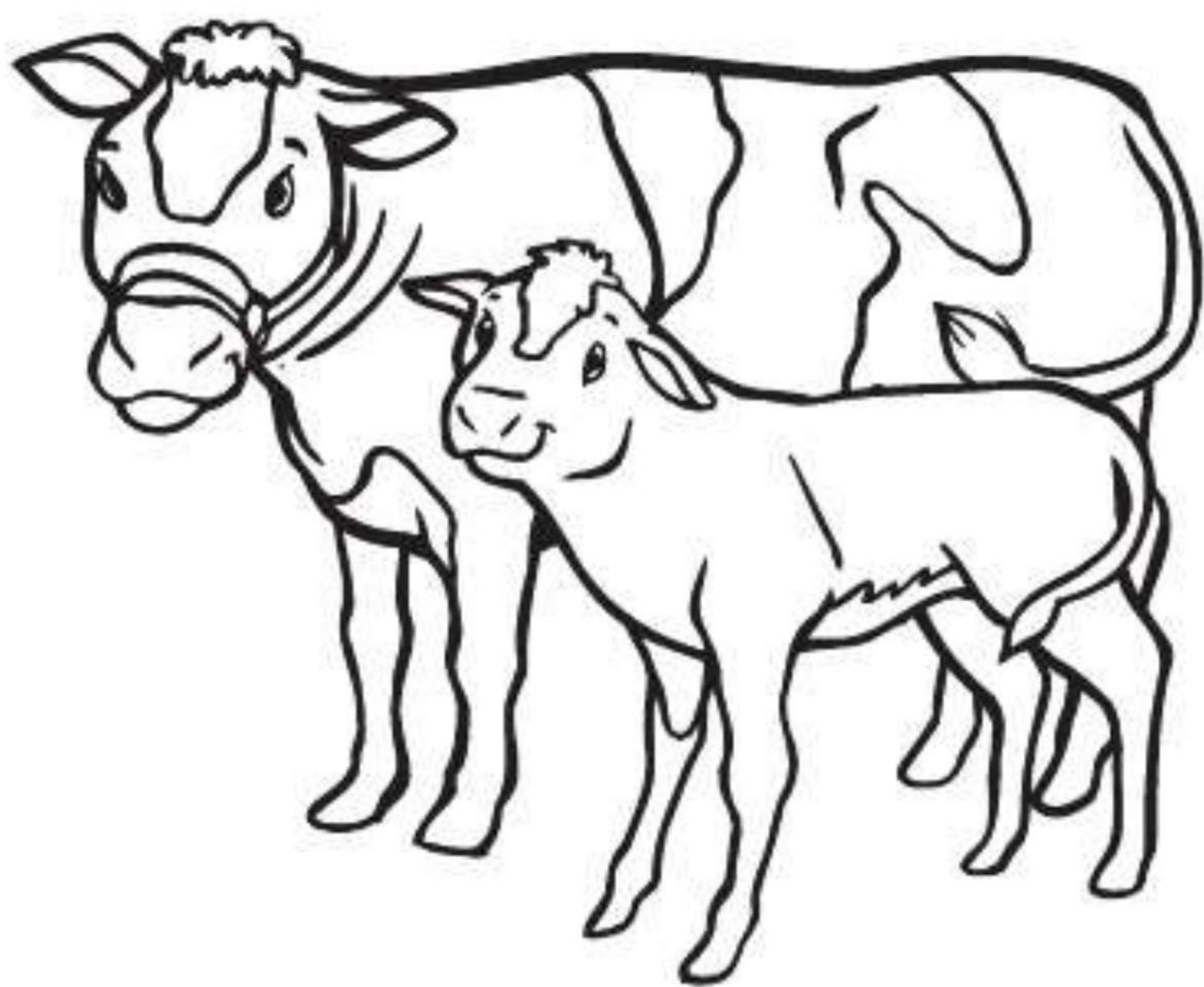

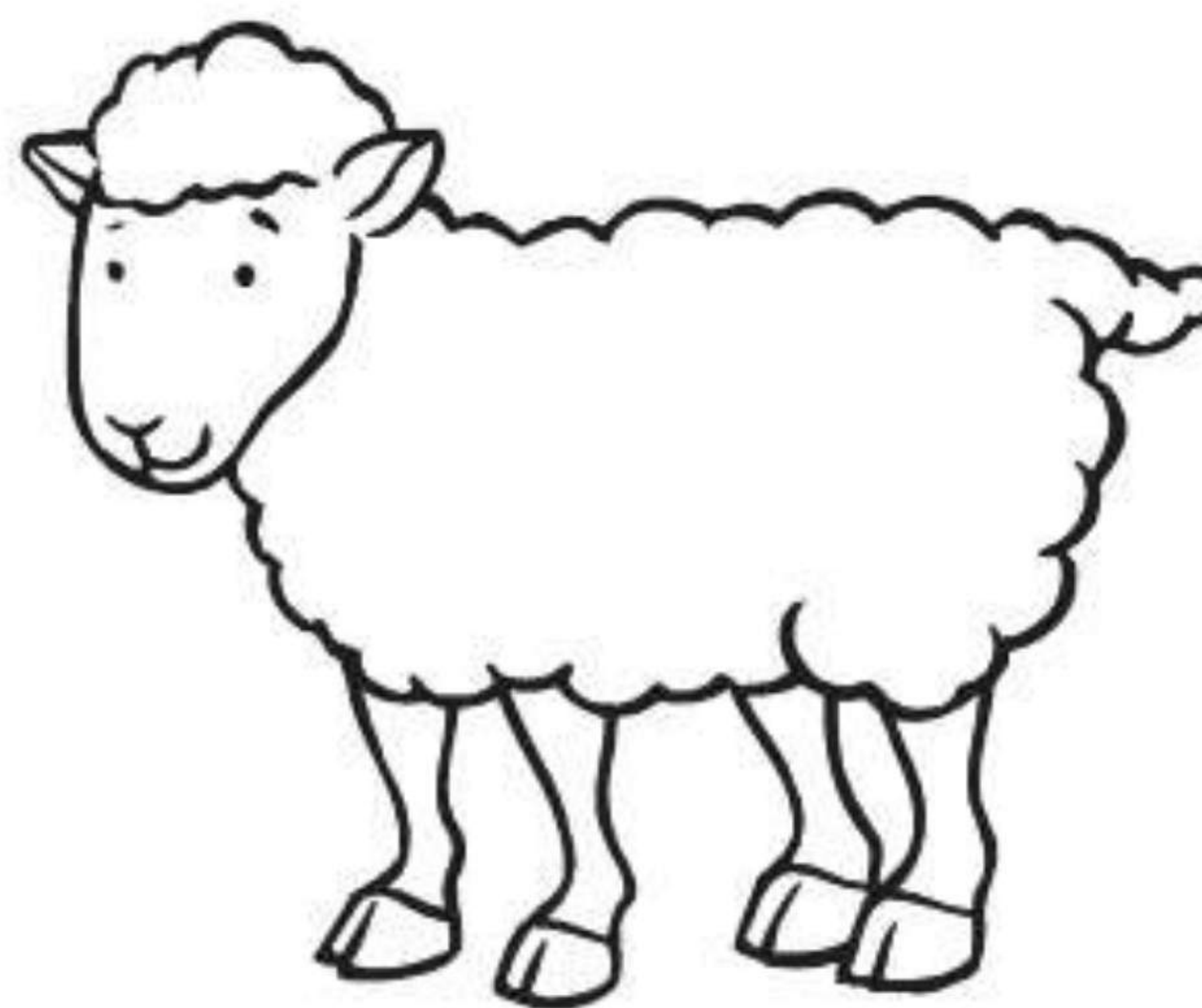

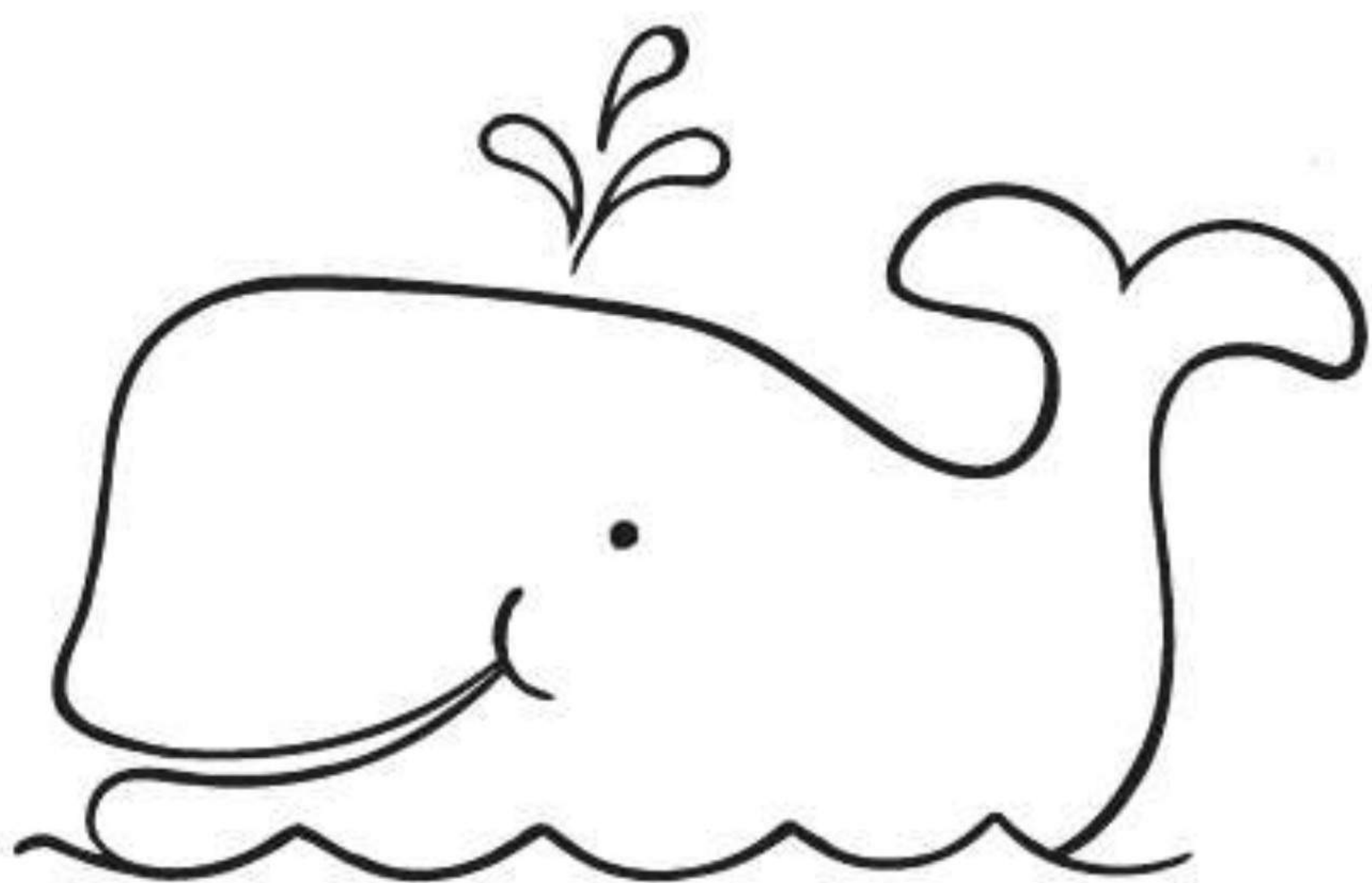

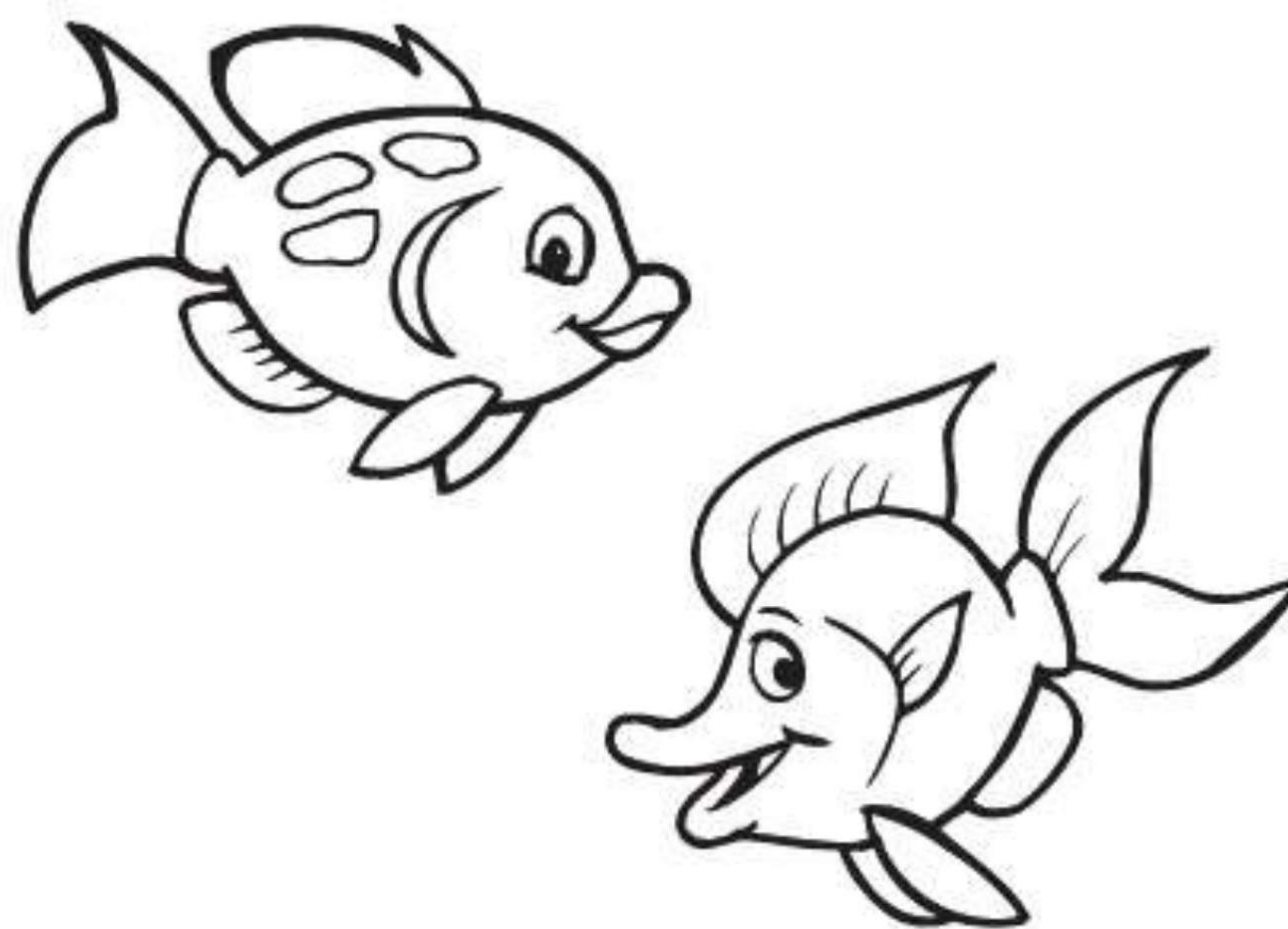





Name _____

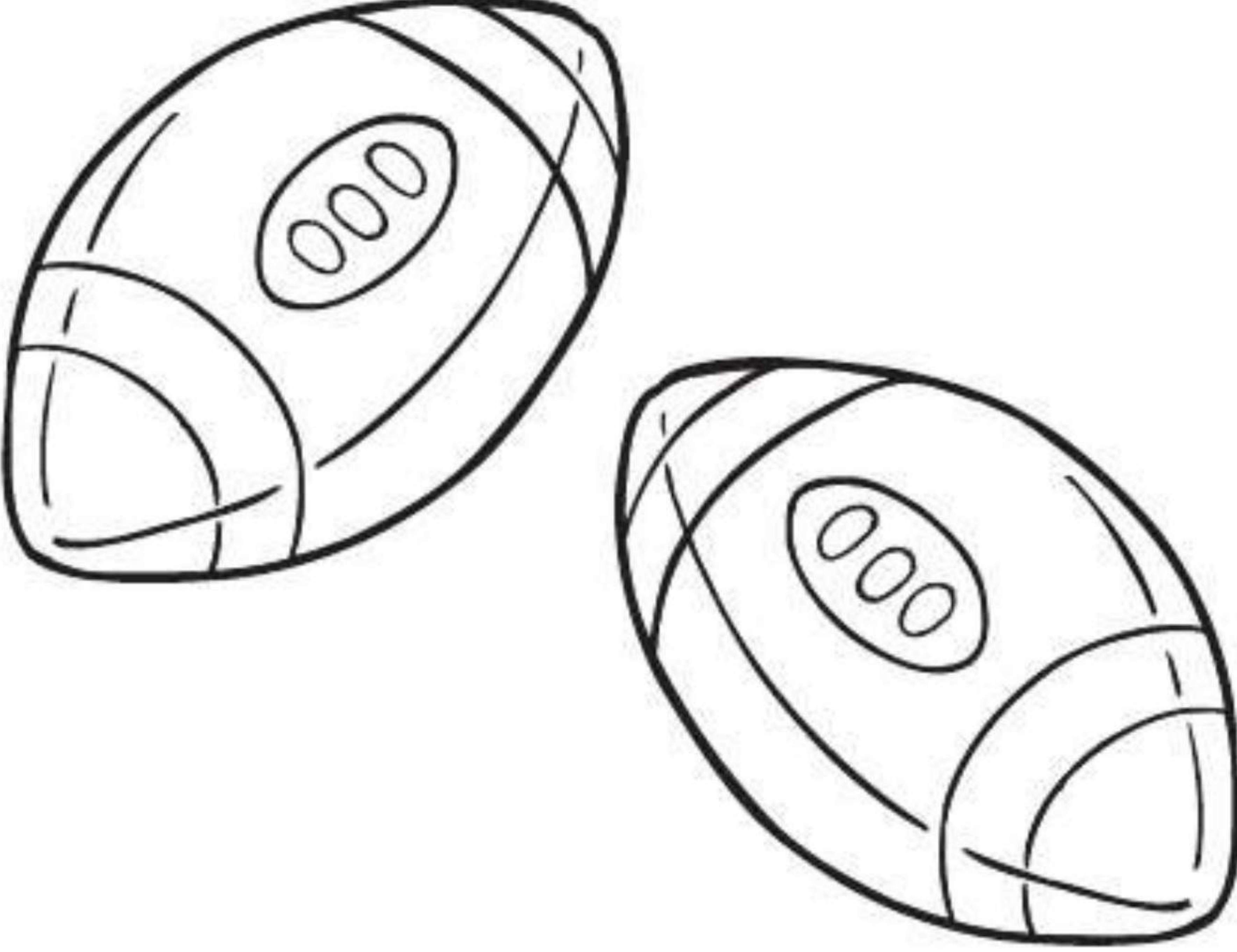

One and Two

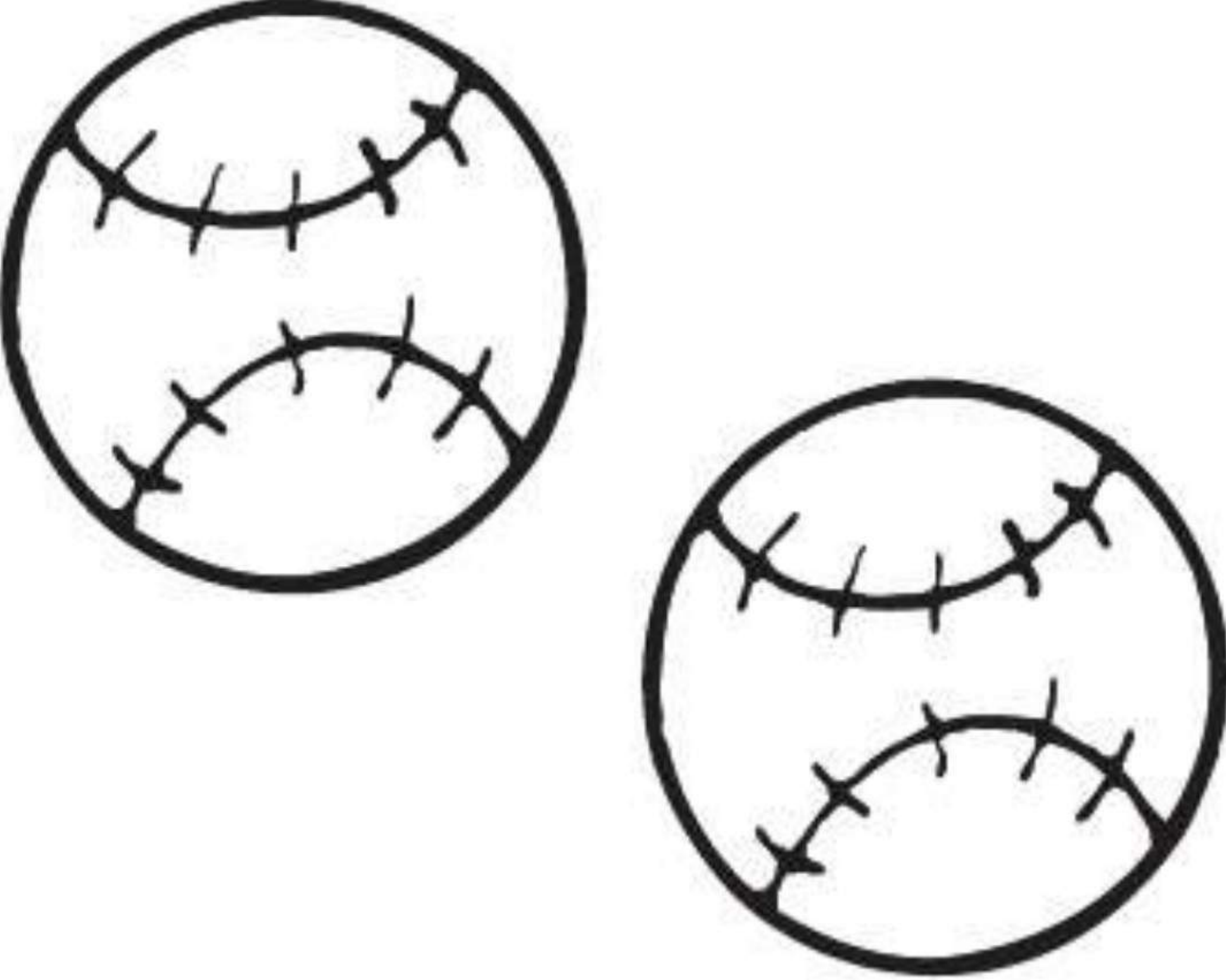
Directions: Count and write the number in each box. Circle the groups of one. Color the groups of two.

 _____	 _____
 _____	 _____



Three and Four 3, 4

Directions: Trace and write the numbers **3** and **4**. Then, count and write the correct number.

Tracing practice for numbers 3 and 4 on a three-line grid (top blue, middle red, bottom blue).

Row 1 (Number 3):
- A dashed number 3 with a starting dot and a curved arrow labeled '1' showing the stroke direction.
- A dashed number 3 with a starting dot.
- Two dots on the top blue line for starting points.

Row 2 (Number 4):
- A dashed number 4 with a starting dot and arrows labeled '1' and '2' showing the stroke directions (vertical down, horizontal right, vertical down).
- A dashed number 4 with a starting dot.
- Two dots on the top blue line for starting points.

Counting activity with two boxes.

Left box: Contains 3 orange paw prints. Below the prints is a horizontal line for writing the count.

Right box: Contains 4 brown paw prints. Below the prints is a horizontal line for writing the count.



Three and Four

Directions: Count and write the number in each box. Circle the groups of three. Color the groups of four.

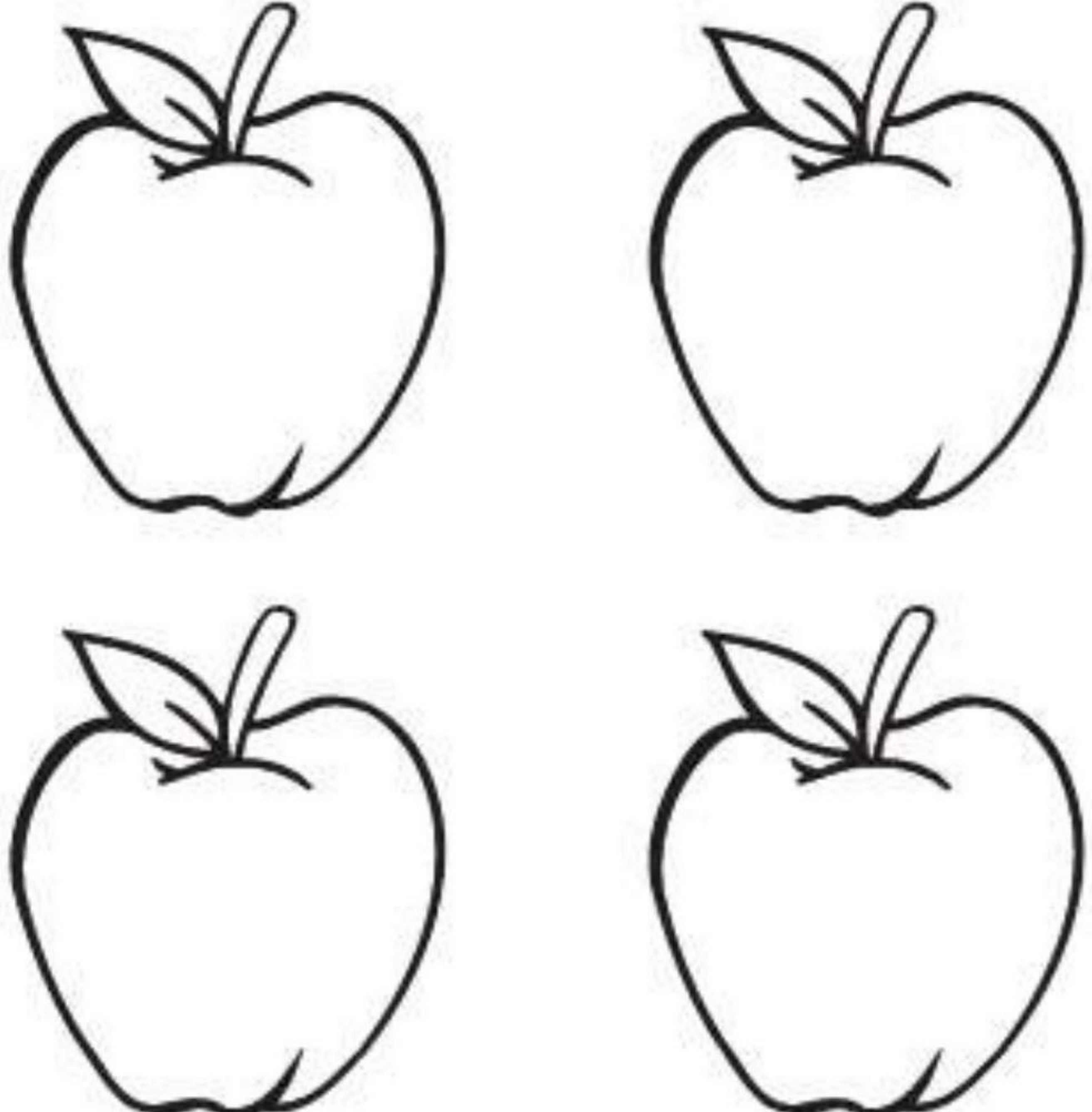
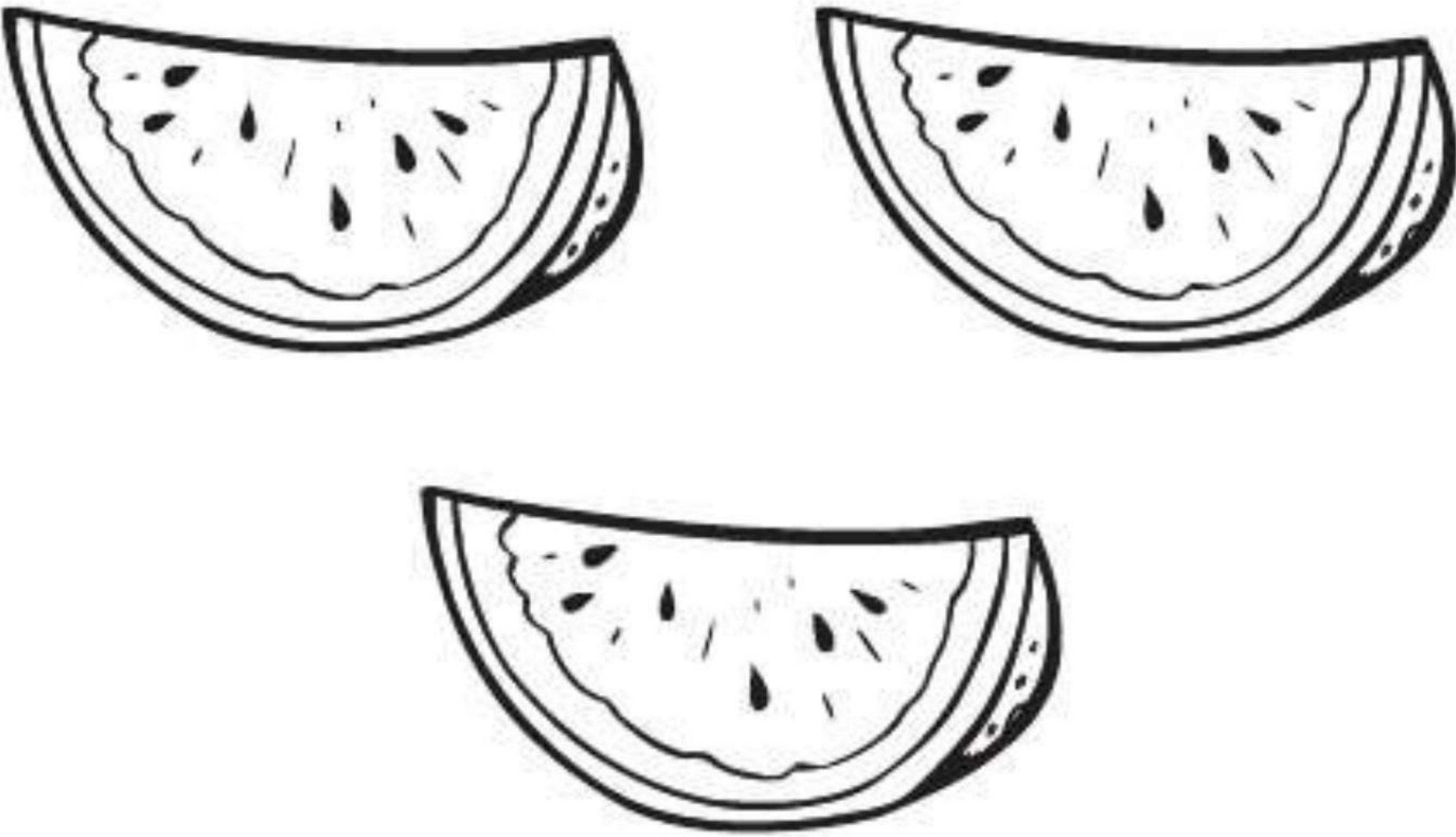
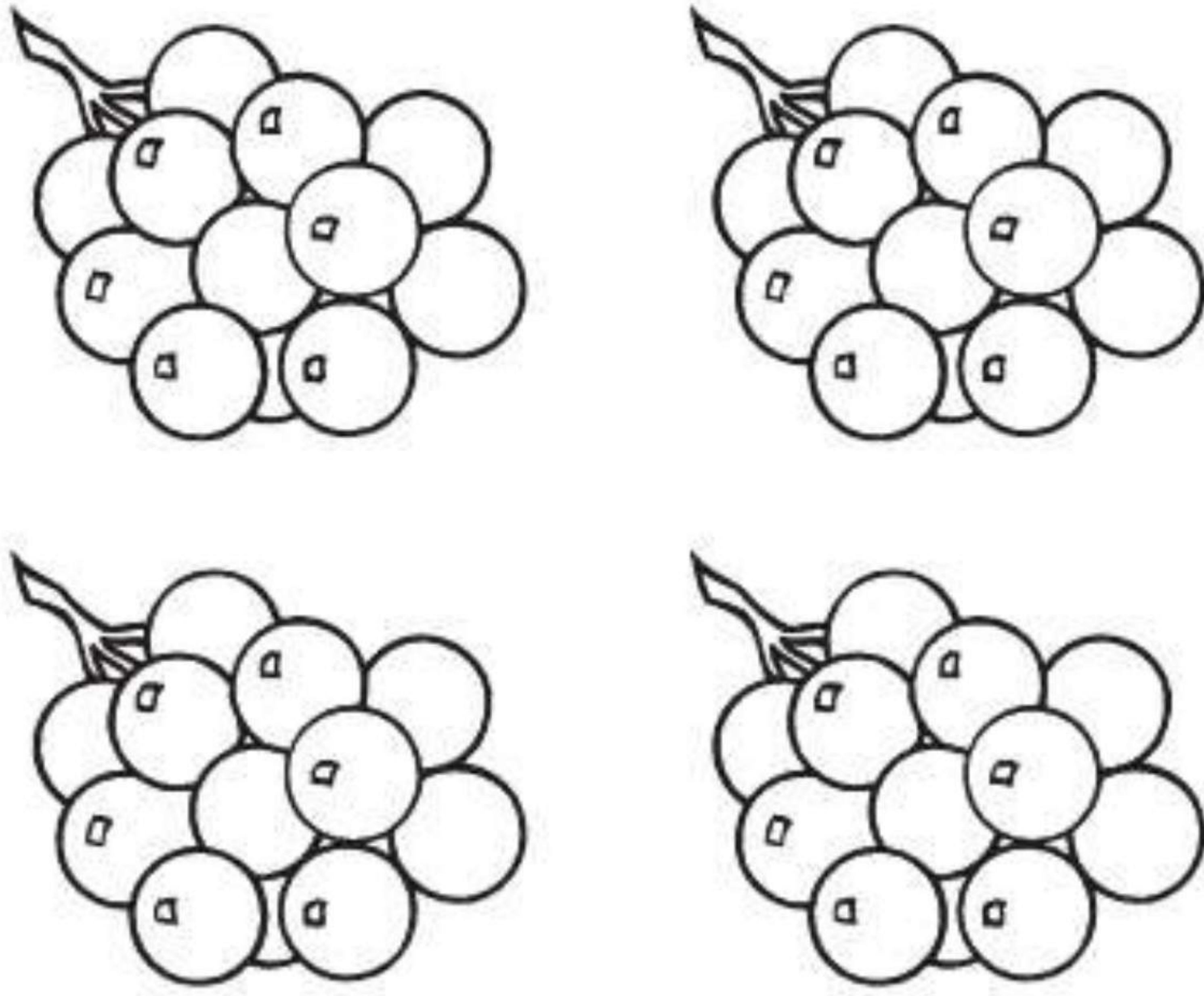
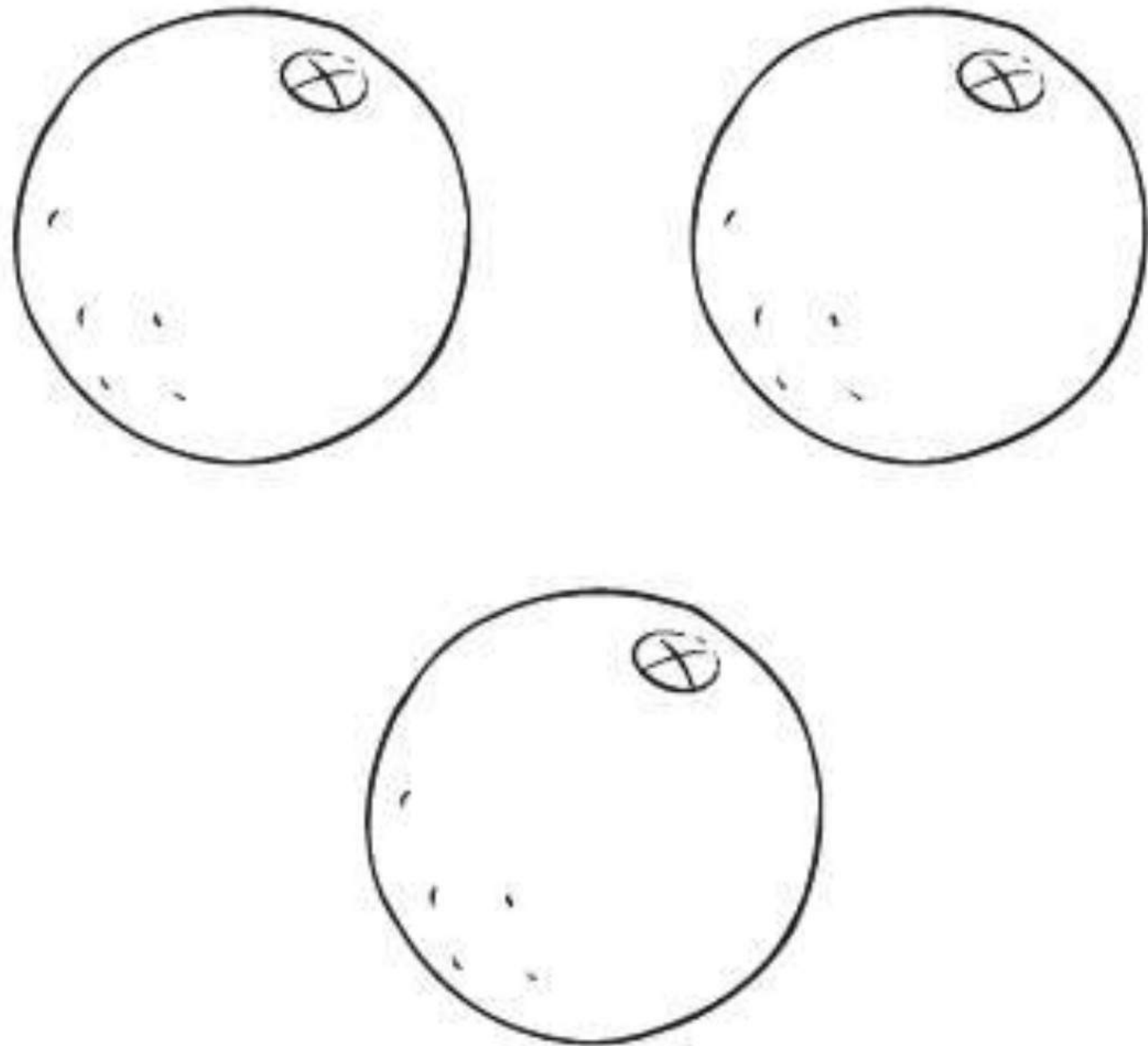
 _____	 _____
 _____	 _____



Three and Four

Directions: Count and write the number in each box. Circle the groups of three. Color the groups of four.

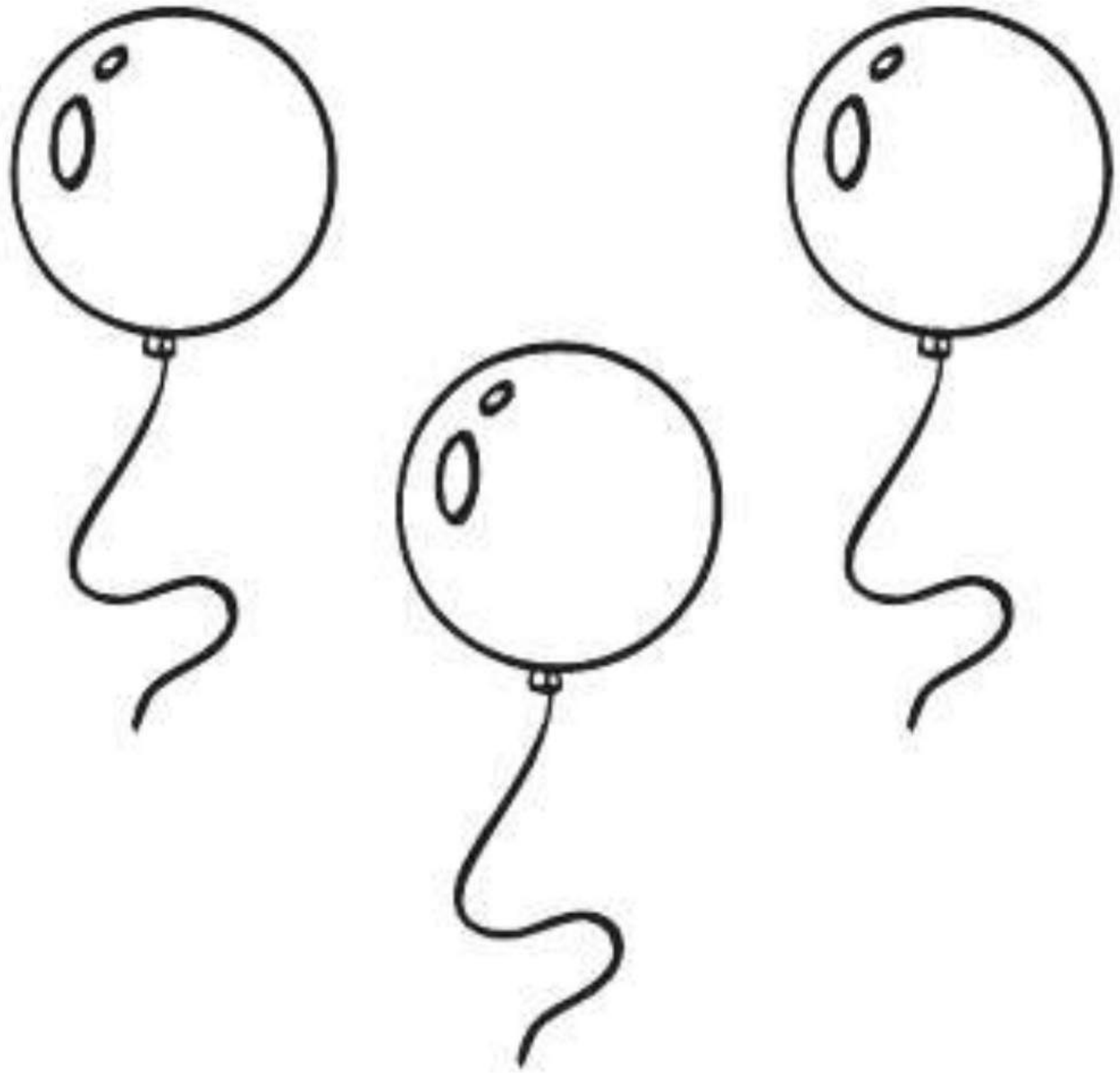
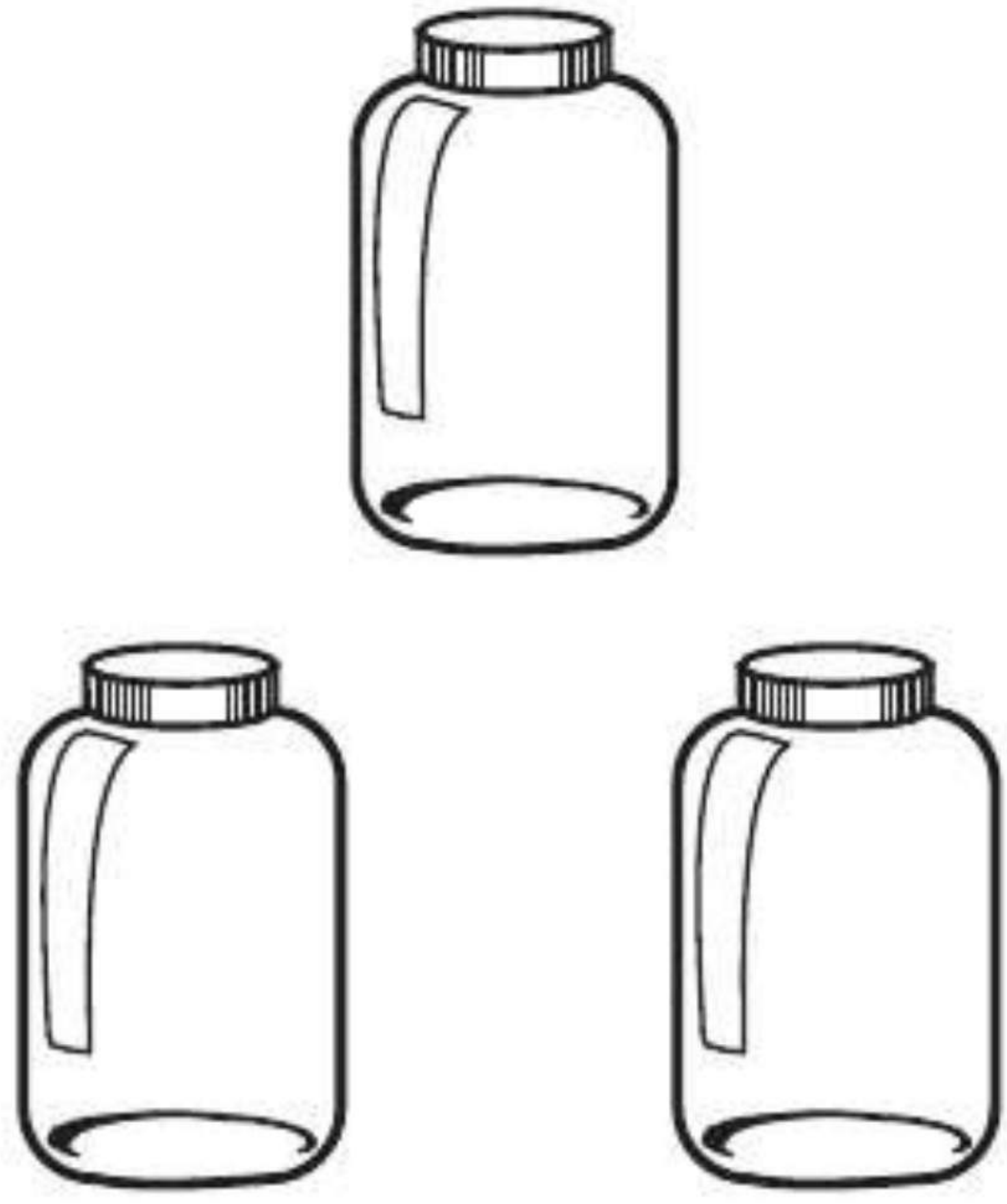
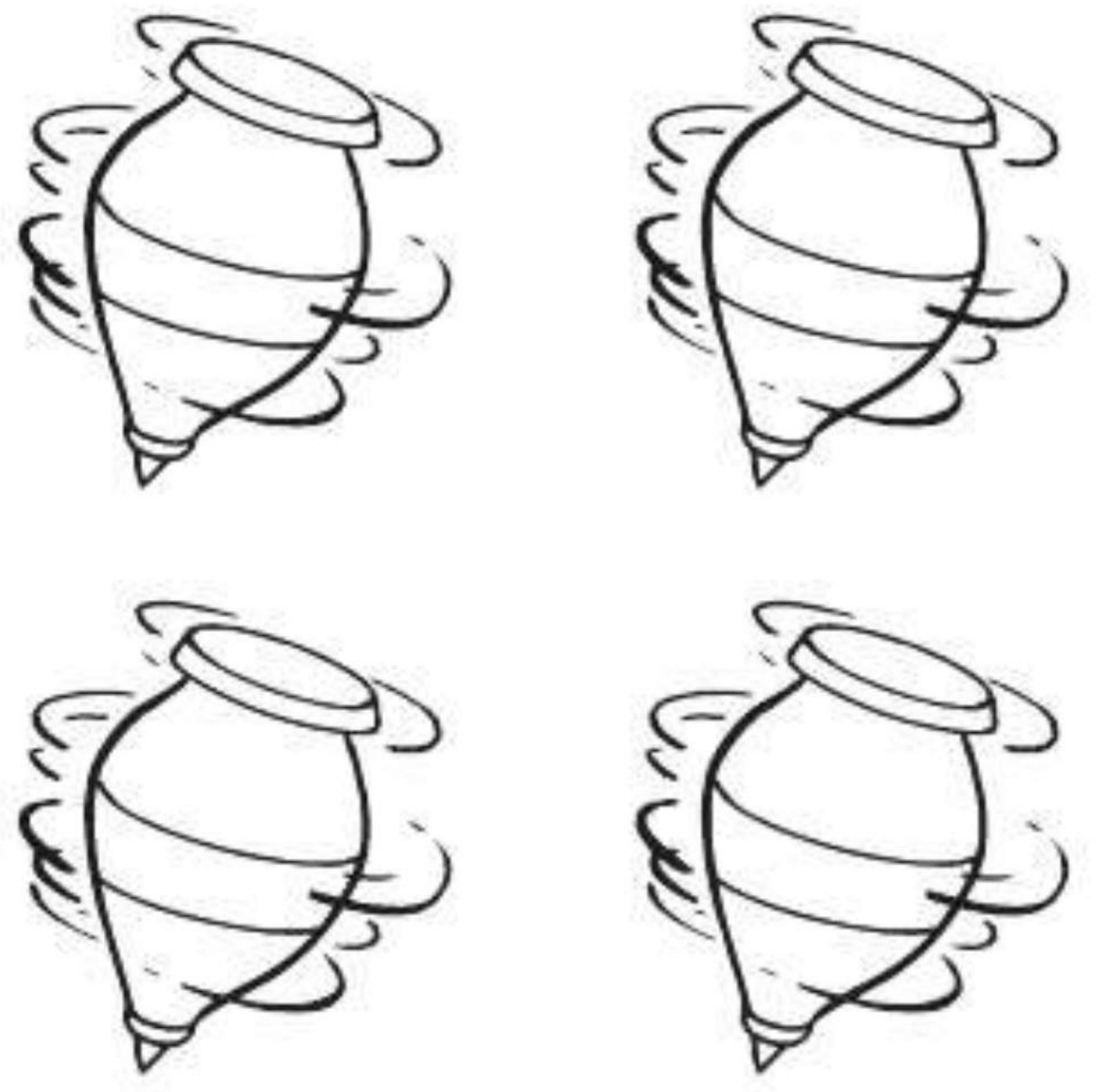
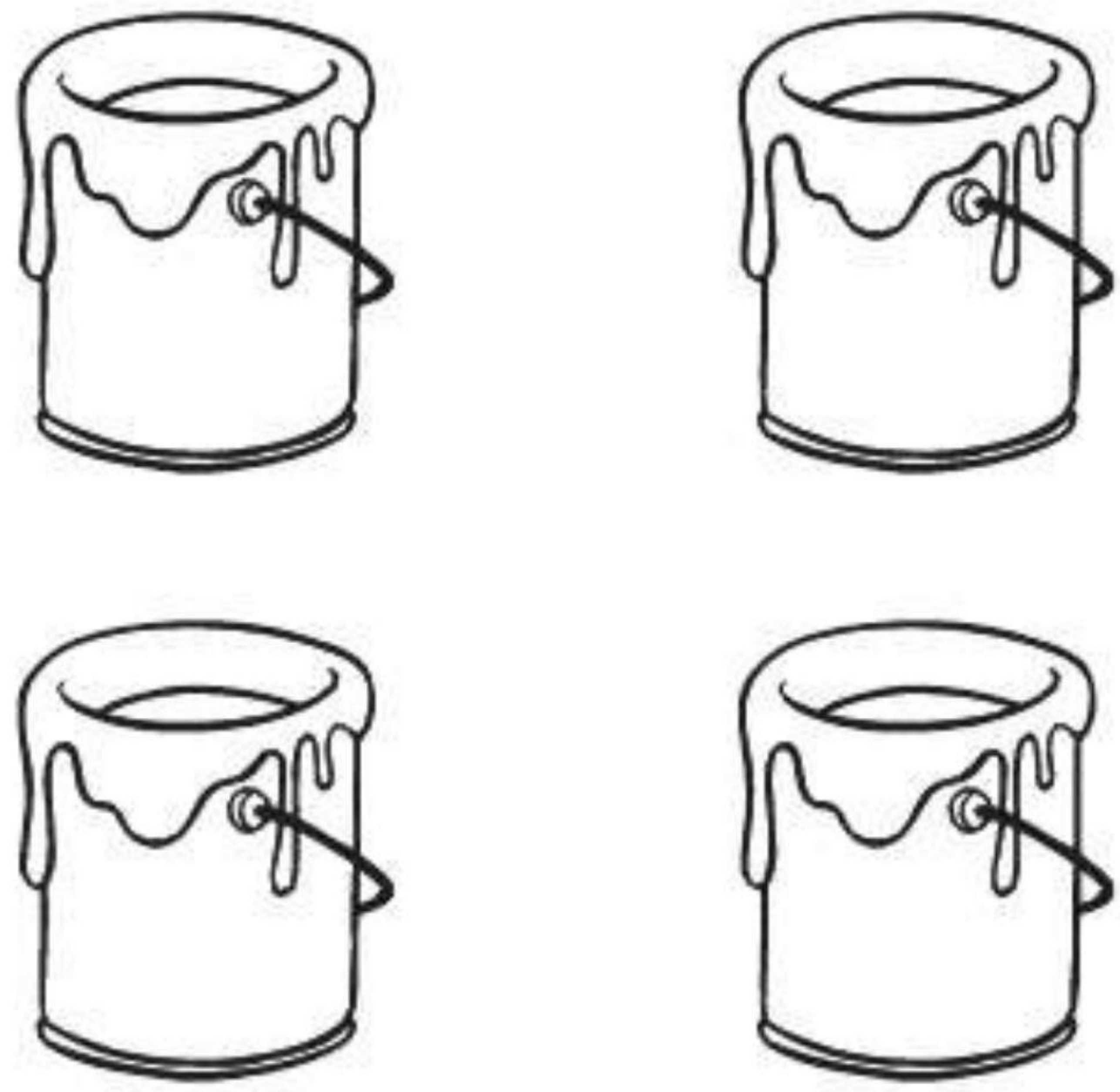
 _____	 _____
 _____	 _____

Name _____



Five 5

Directions: Trace and write the number **5**. Then, color 5 dogs in each box.

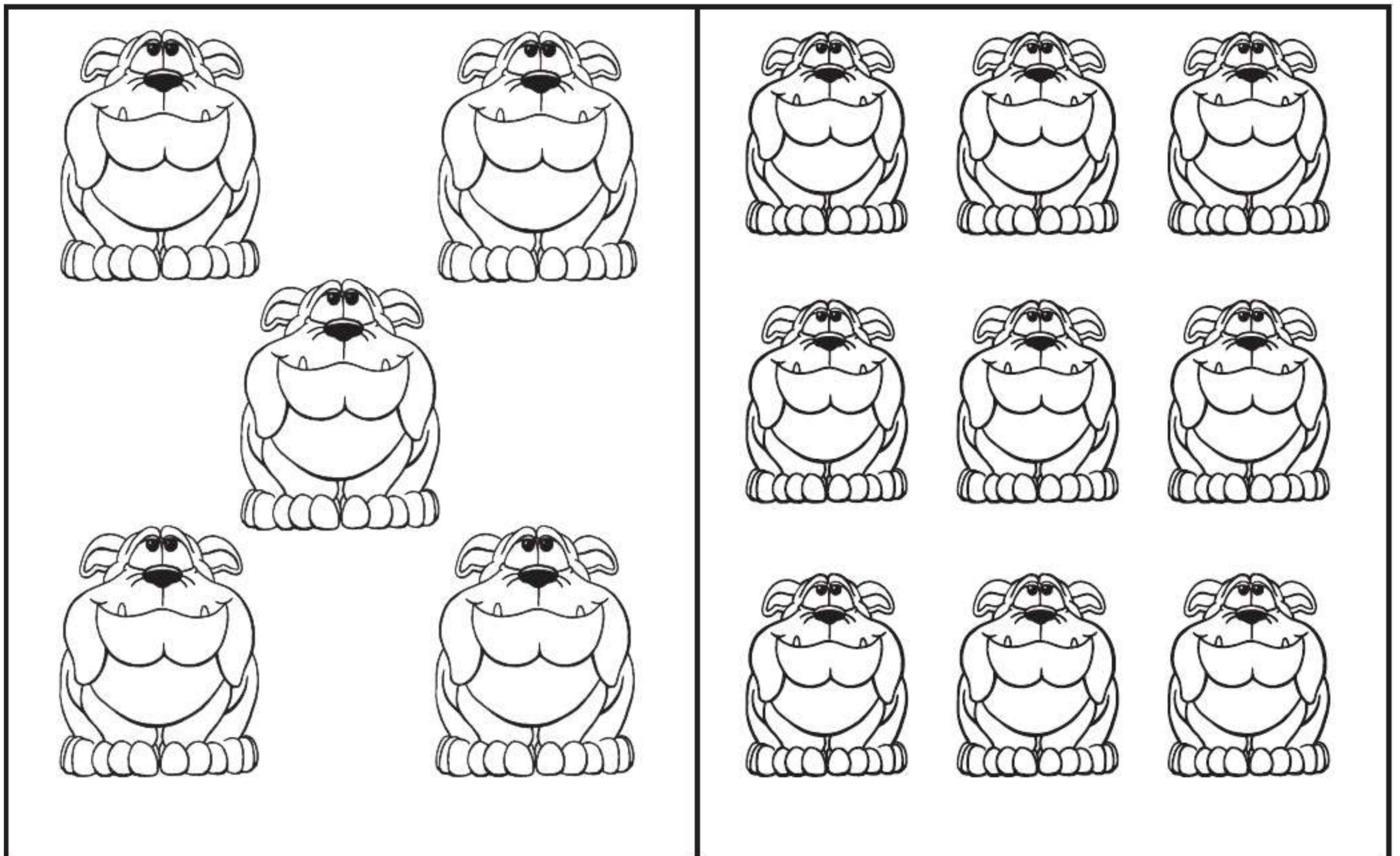
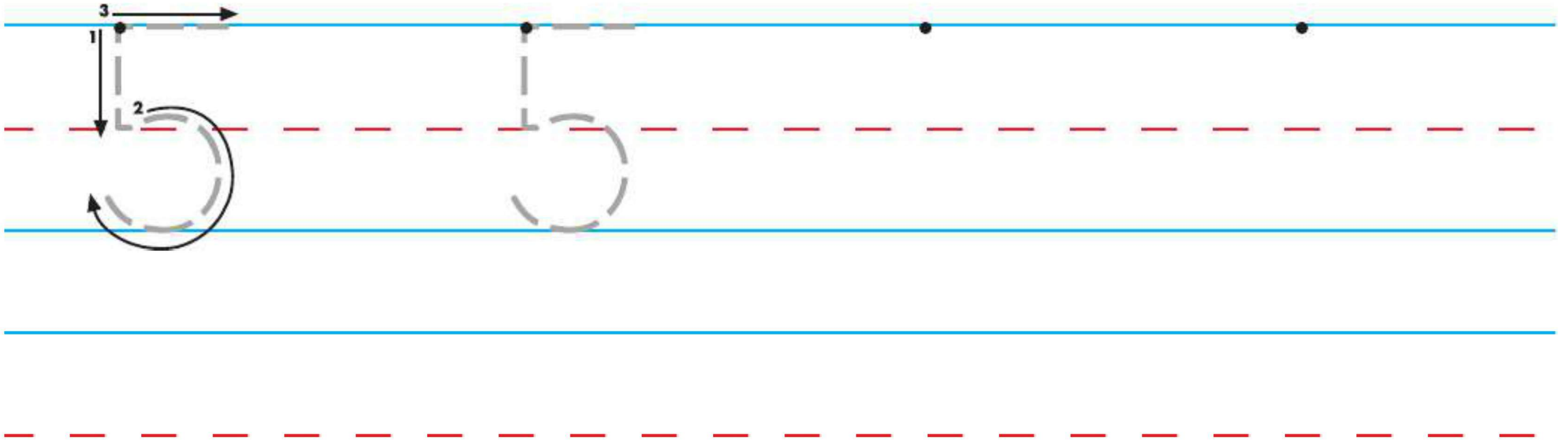



Five 5

Directions: Trace and write the word **five**. Then, write the correct number on each domino.

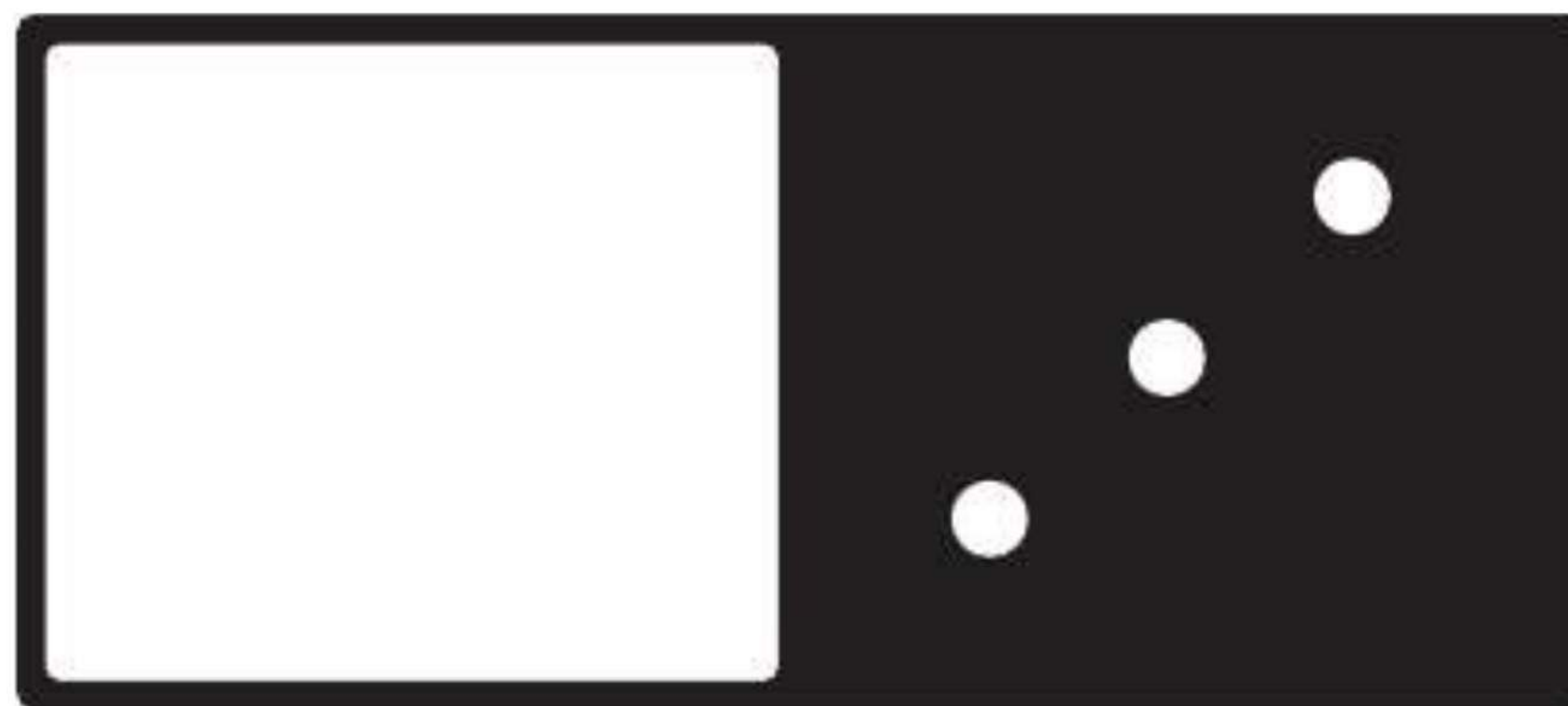
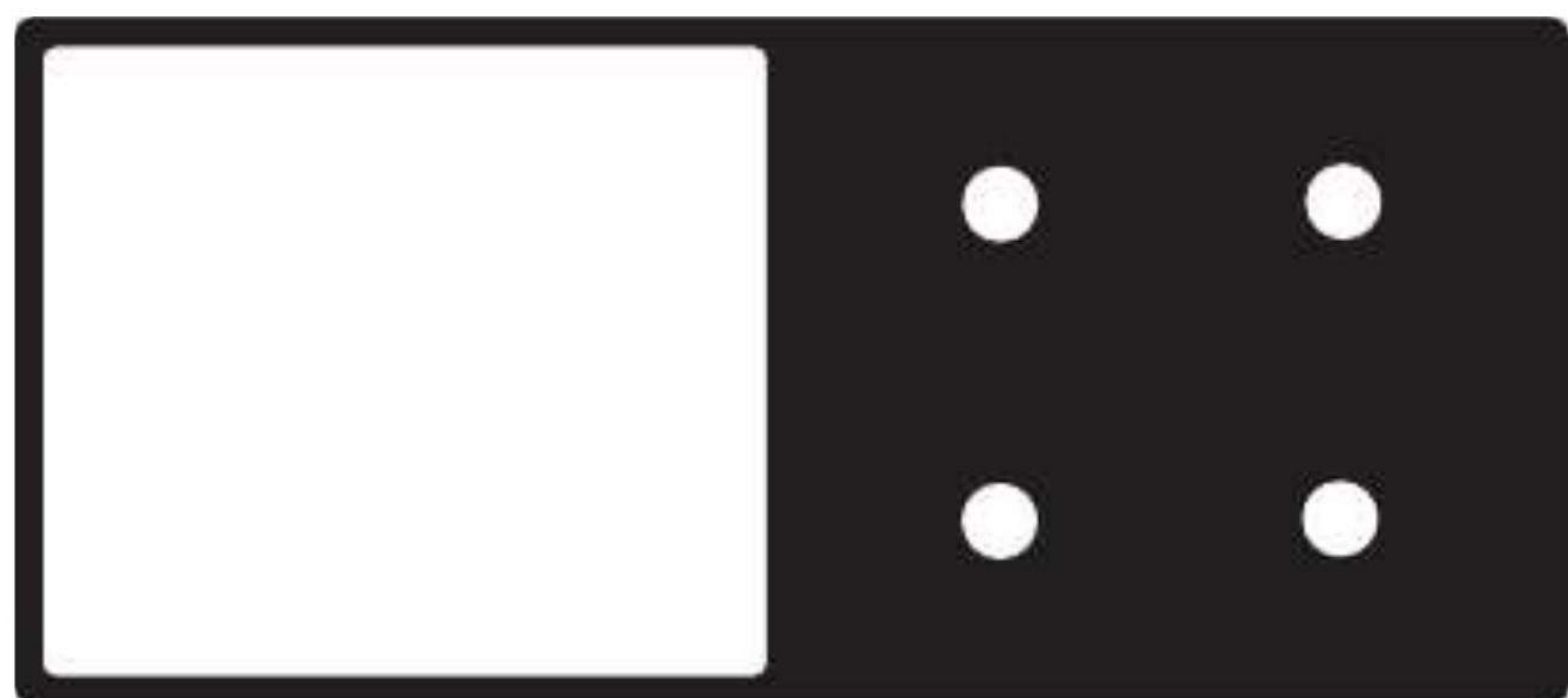
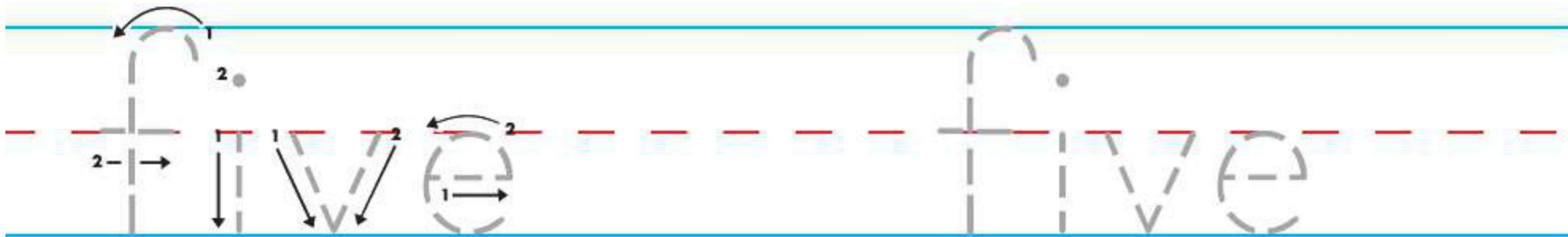

Review Numbers 1-5

Directions: Look at the picture. Read the questions. Circle the correct number.

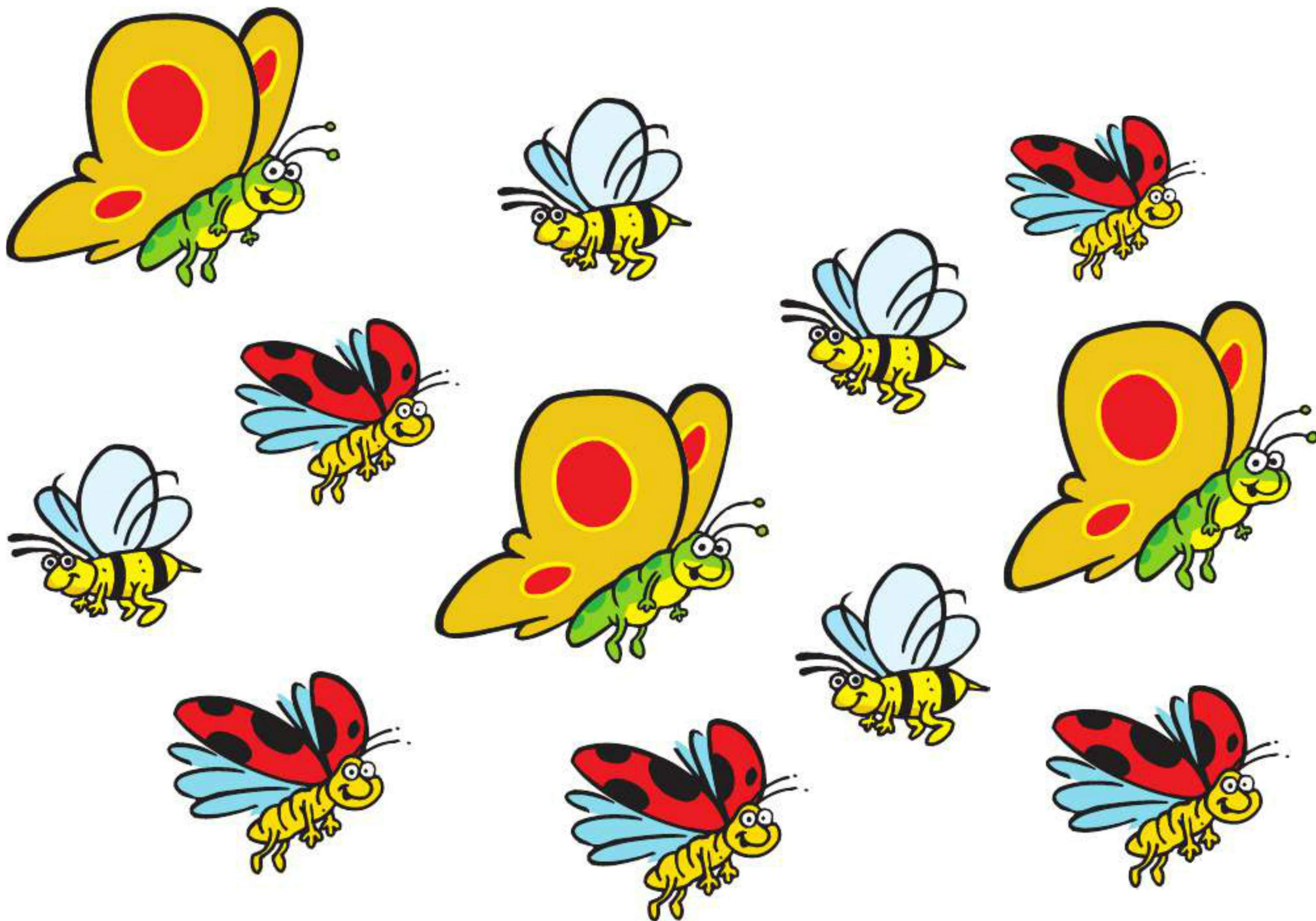

◆ How many in  all? 3 4 5

◆ How many in  all? 3 4 5

◆ How many in  all? 3 4 5



Review Numbers 1-5

Directions: Count the balloons, then write the correct number on the line.







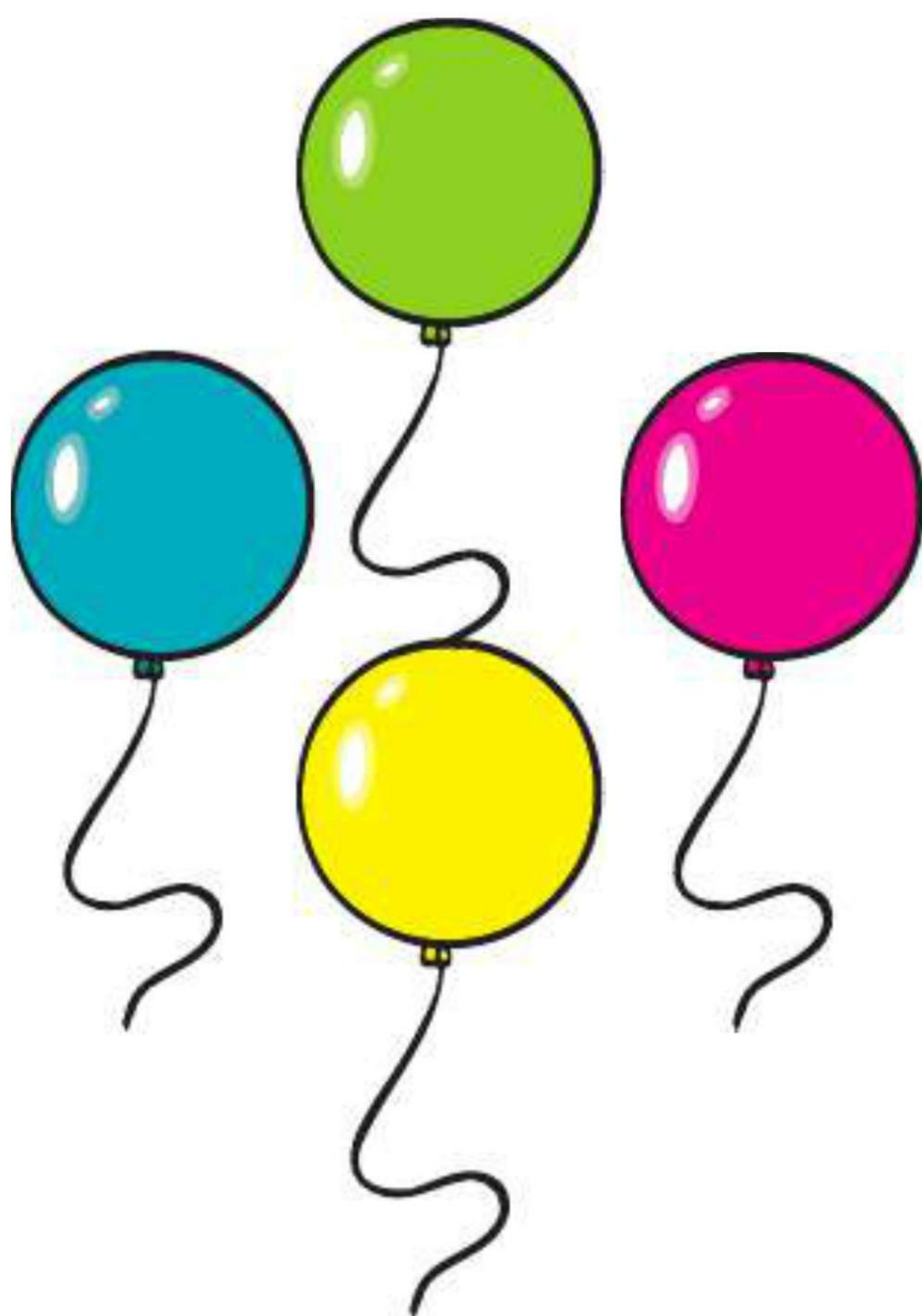



Name _____

NUMBERS 0-20



Six 6

Directions: Trace and write the number 6. Then, draw six coins in the piggy bank.

Tracing practice area with two sets of handwriting lines. Each set consists of a solid top blue line, a dashed middle red line, and a solid bottom blue line. The first set contains a solid number 6 with a starting dot and a curved arrow indicating the stroke direction, followed by a dashed number 6 for tracing. The second set contains four starting dots on the top blue line for independent writing practice.

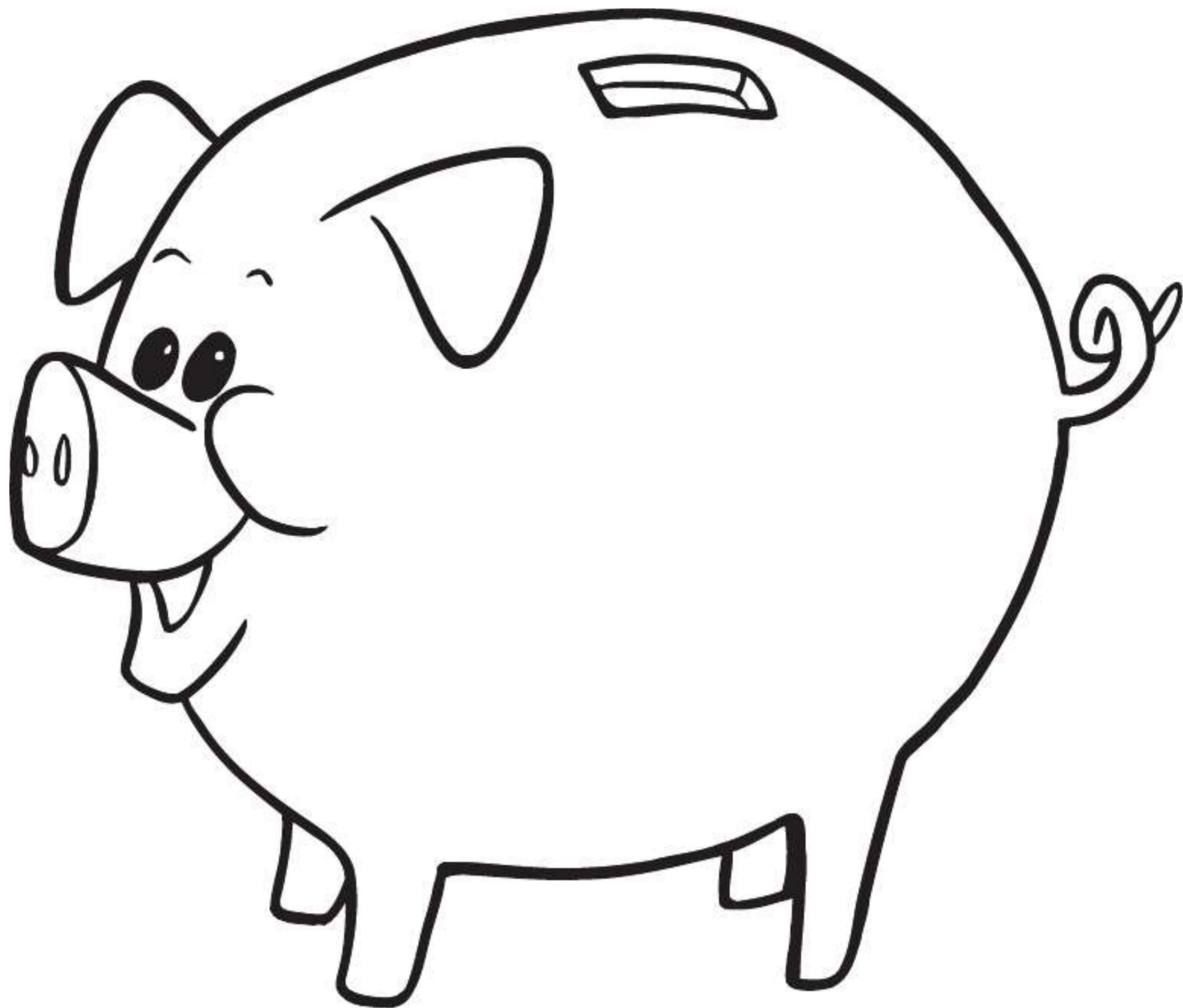



Six 6

Directions: Trace and write the word **six**. Then, draw an **X** on each group of six things.

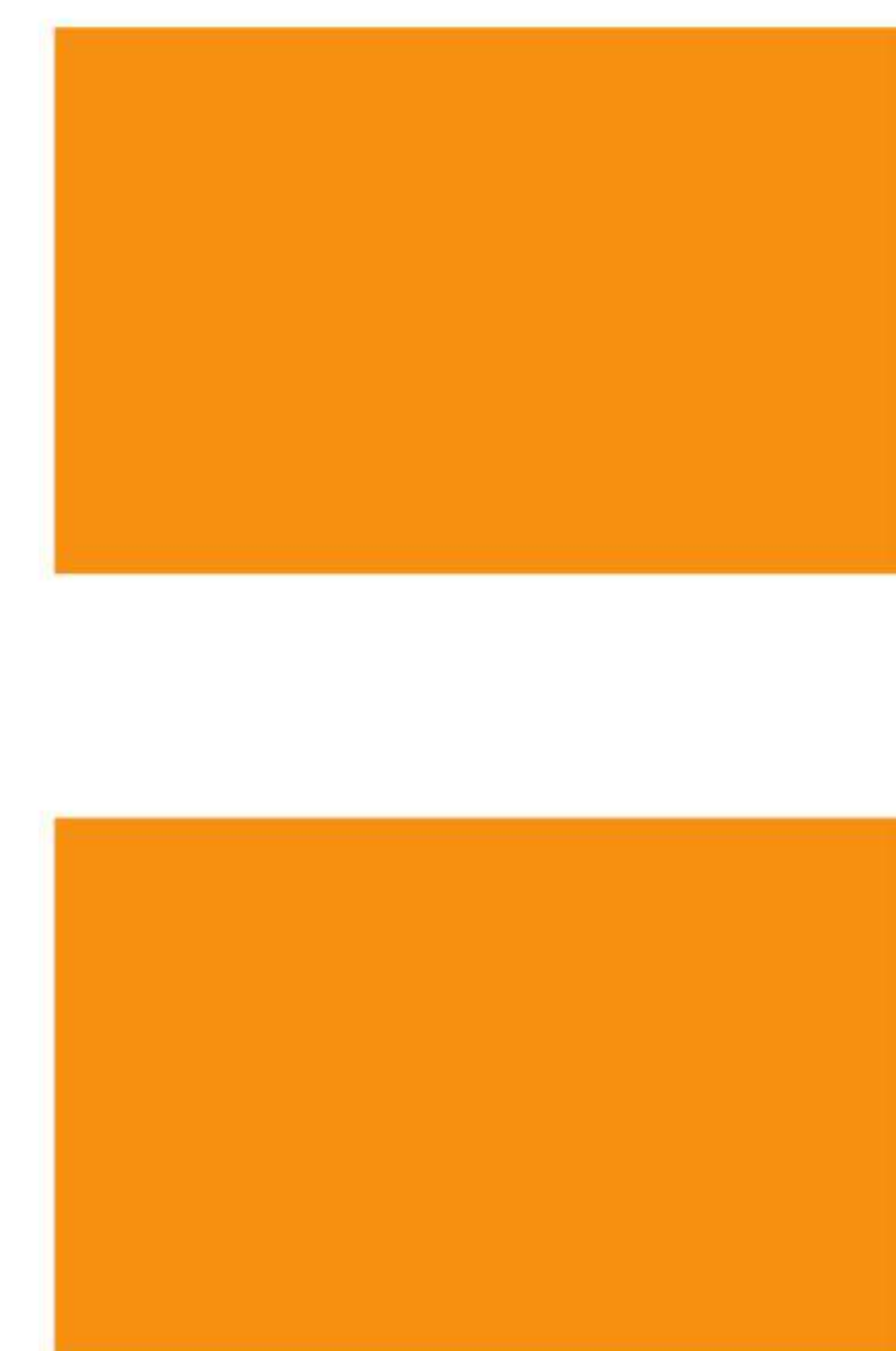
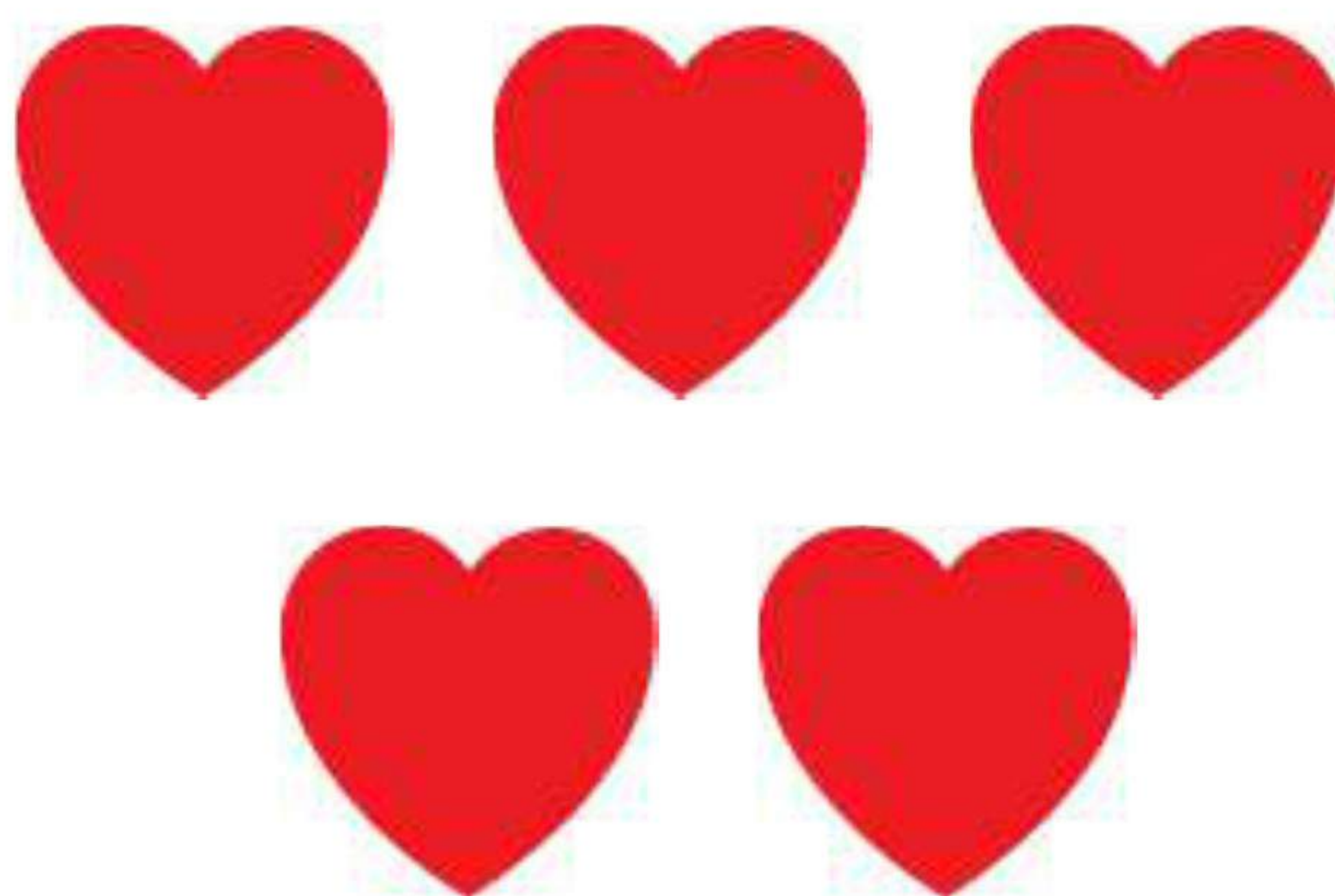
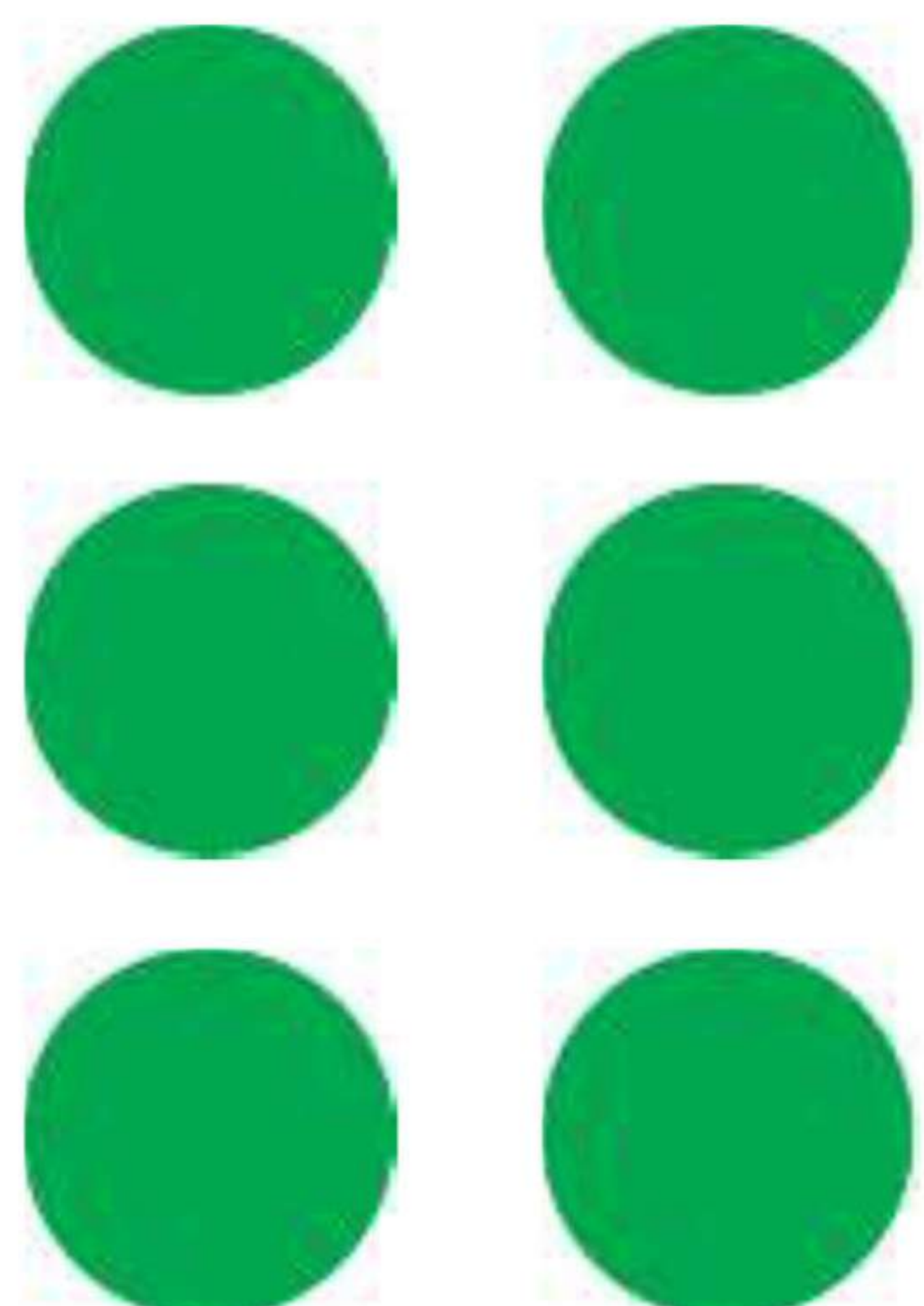
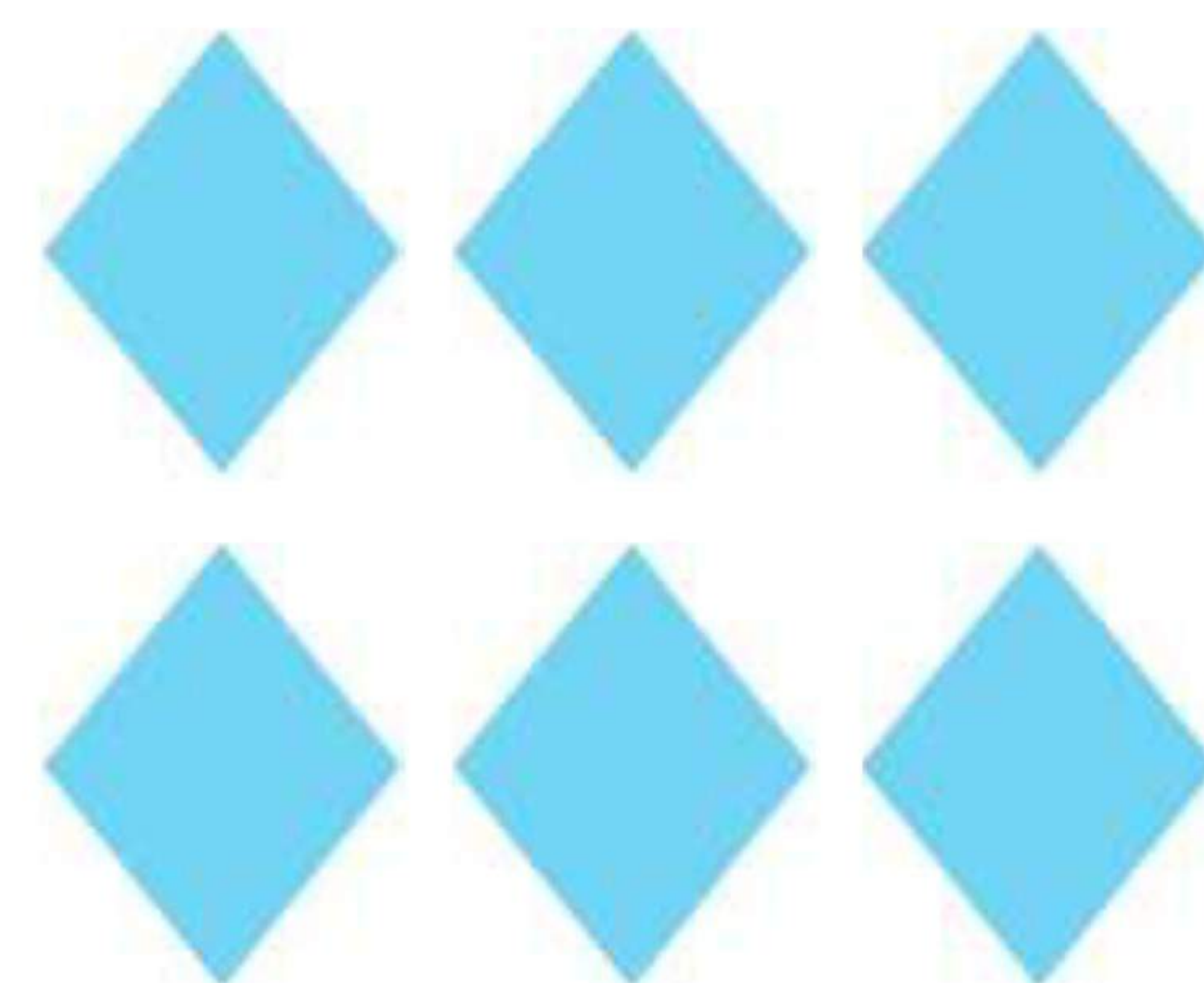
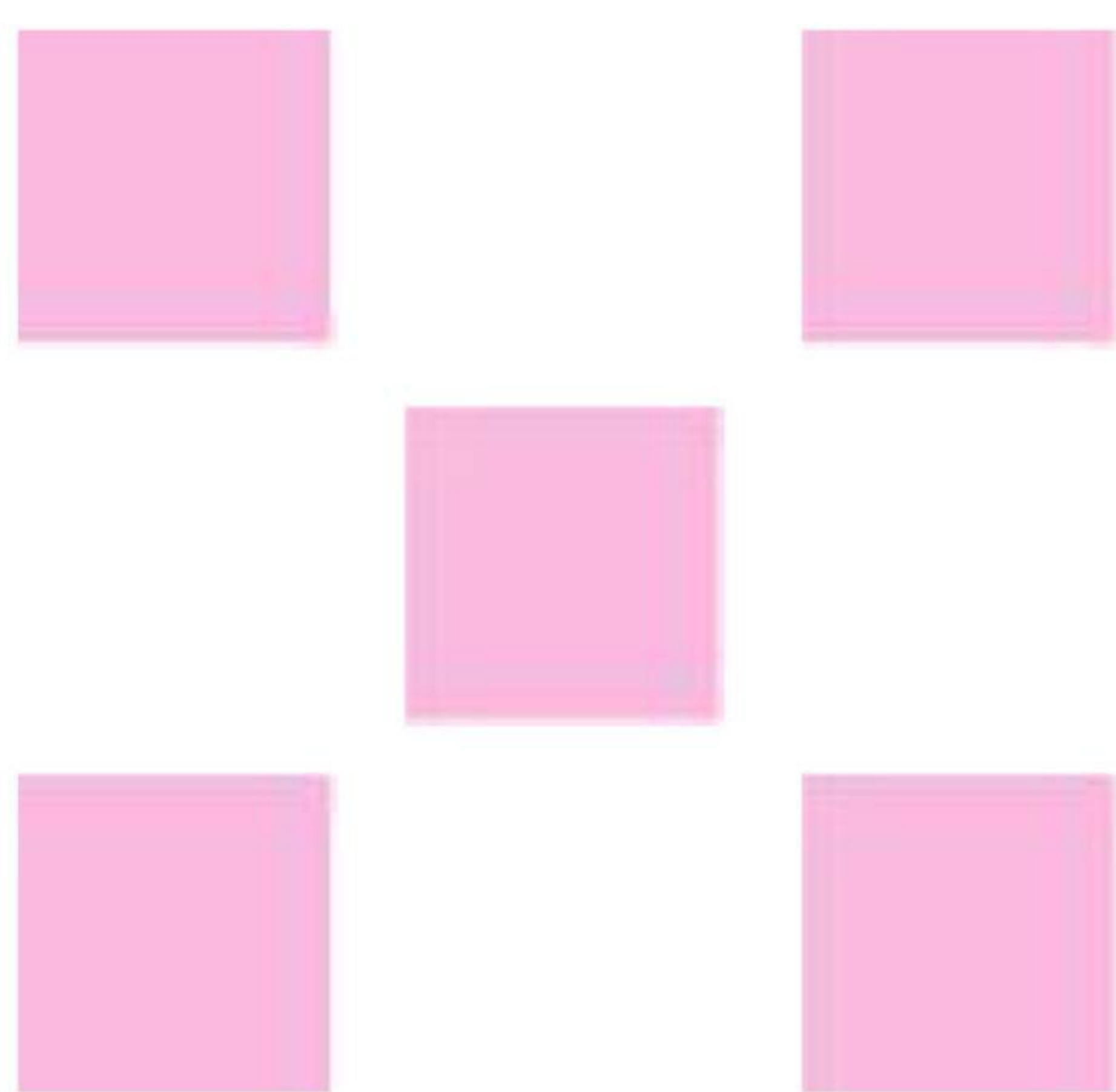
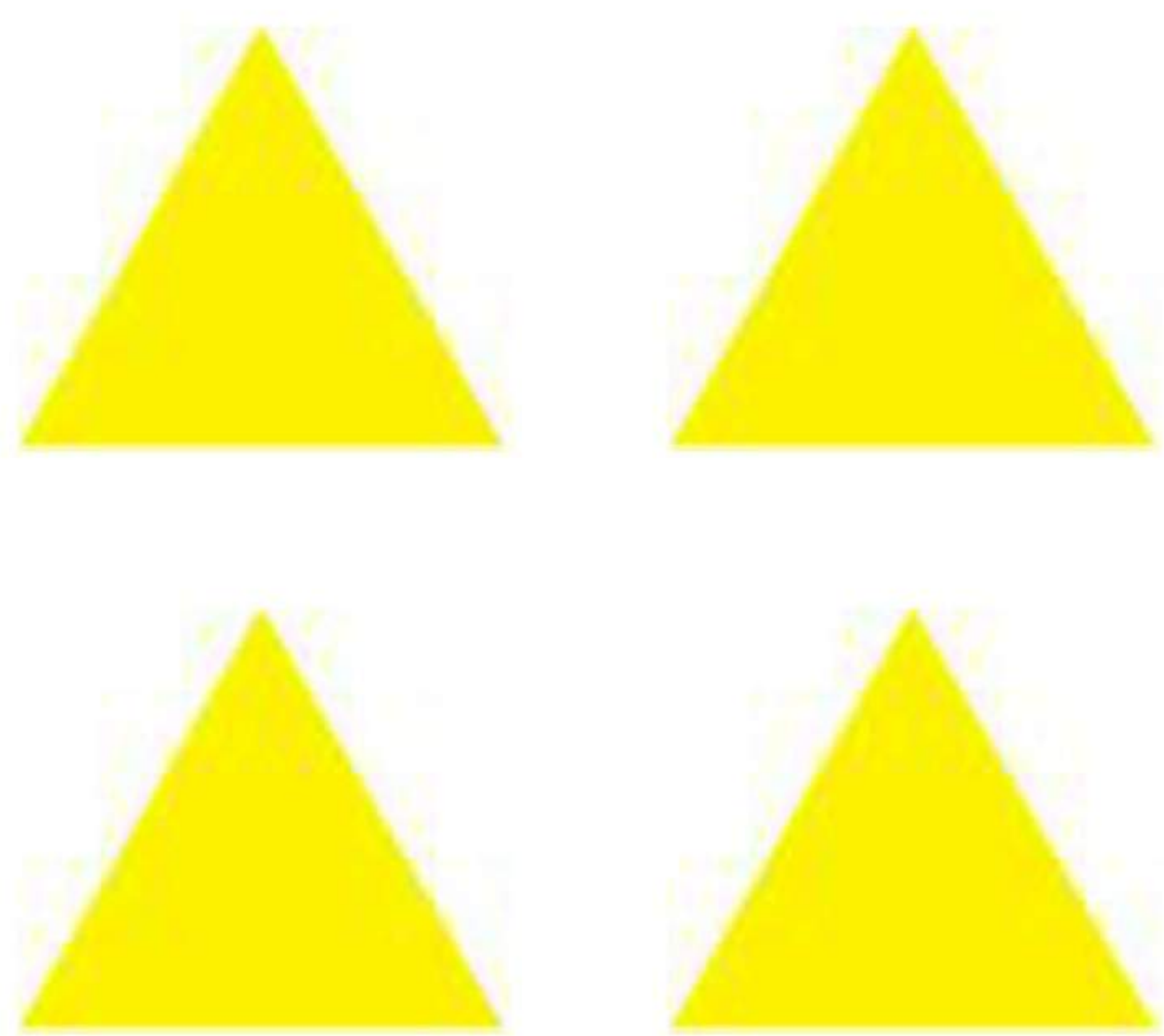

Tracing practice for the word "six". The first row shows the word "six" with numbered arrows indicating stroke order: 1 for the 'S' curve, 2 for the vertical line, and 1 and 2 for the 'X' strokes. The second row shows the word "six" in a dashed format for tracing. Below these are two sets of blank handwriting lines (top blue, middle dashed red, bottom blue) for independent practice.



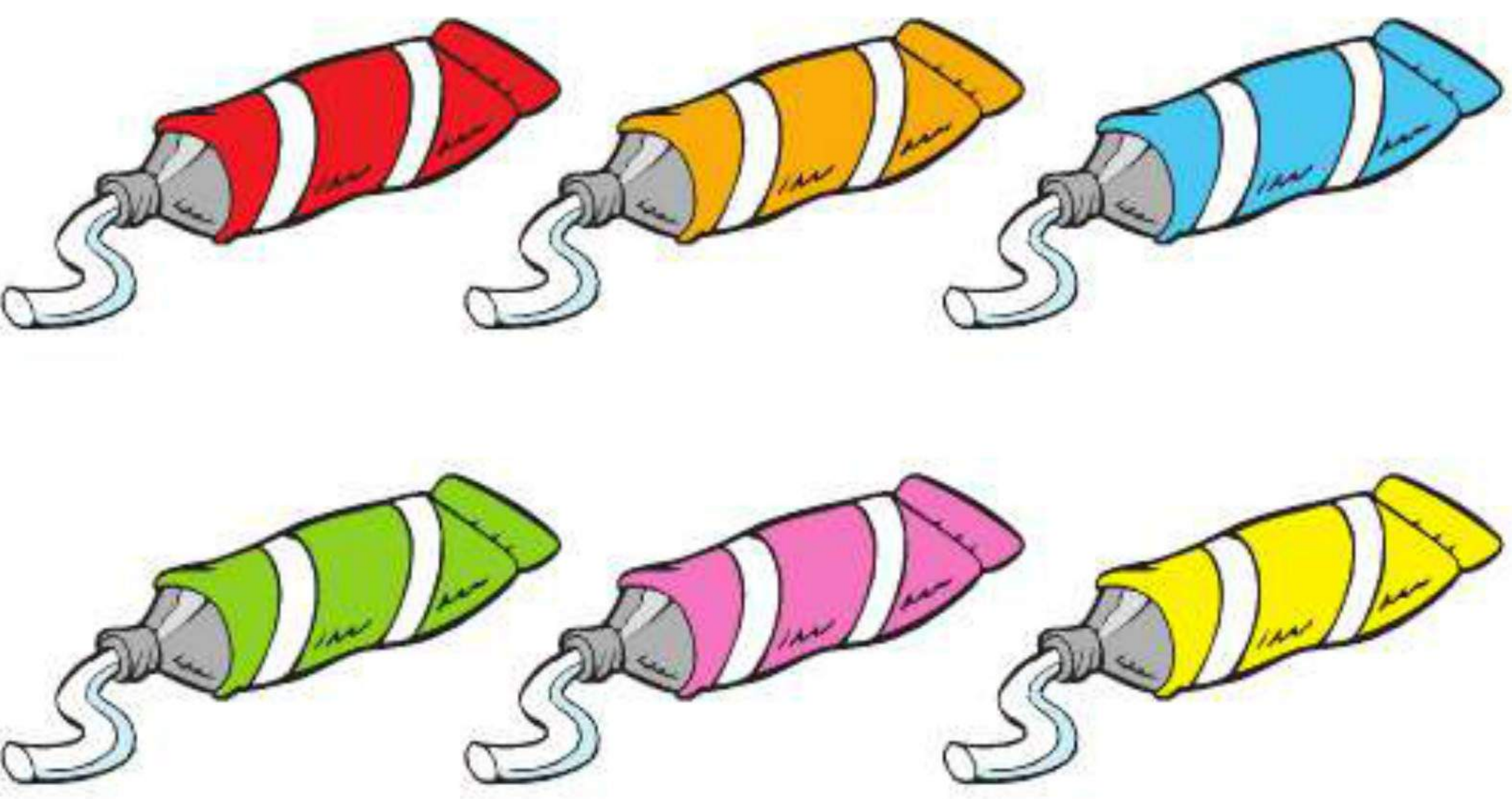

Review Numbers 1-6

Directions: Circle the correct number in each box.

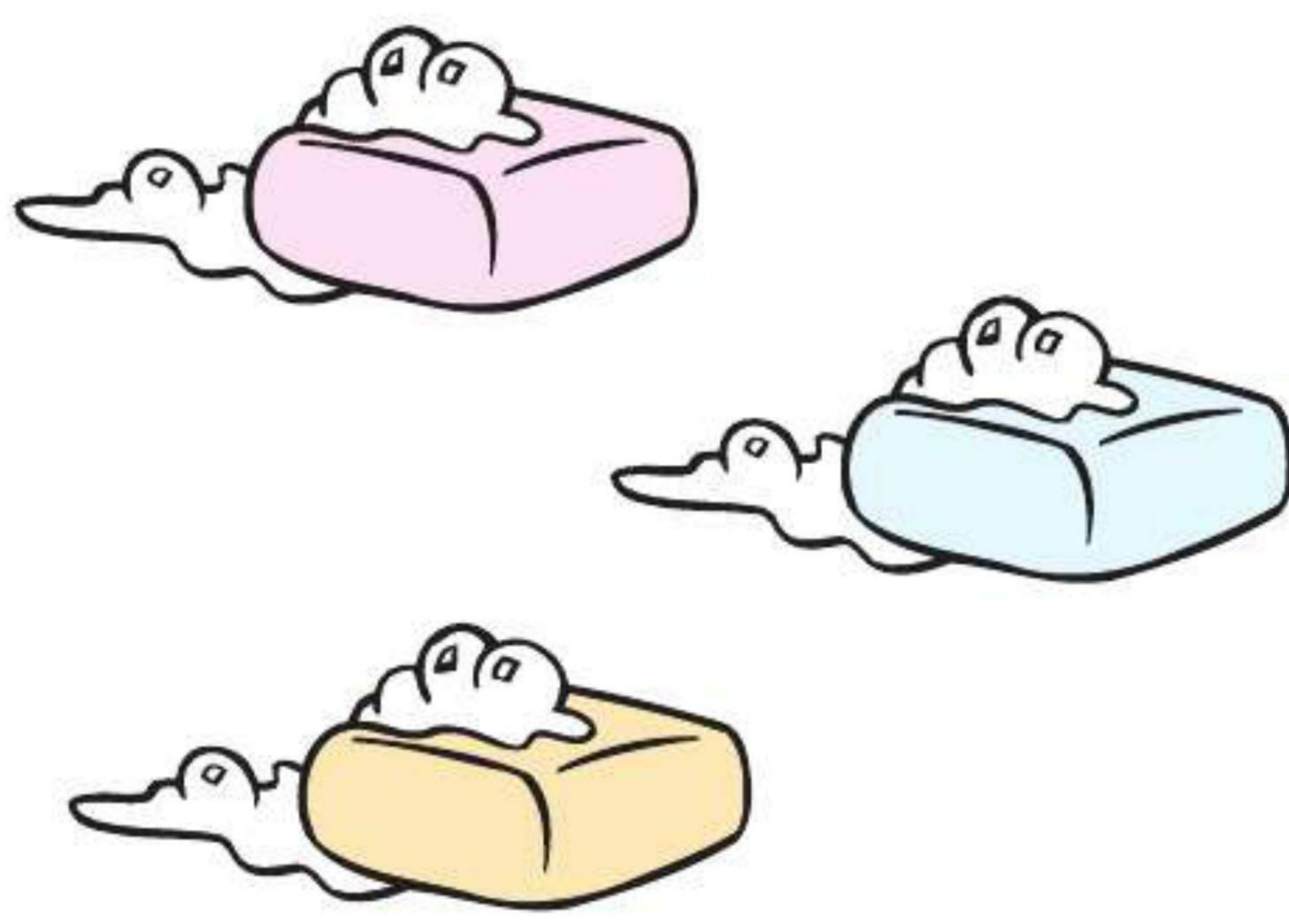
 <p>3 4 5</p>	 <p>4 5 6</p>
 <p>1 2 3</p>	 <p>2 3 4</p>



Seven 7

Directions: Trace and write the number 7. Then, draw seven cookies.

Tracing practice for the number 7. The first line shows a solid number 7 with a starting dot and an arrow labeled '1' indicating the stroke direction. The second line shows a dashed number 7 for tracing. The third and fourth lines are blank with a starting dot and a dashed line for tracing. The fifth and sixth lines are blank with a starting dot and a dashed line for tracing. The seventh and eighth lines are blank with a starting dot and a dashed line for tracing.



Seven 7

Directions: Trace and write the word **seven**. Count the ladybugs. Connect the dots. Color the picture.

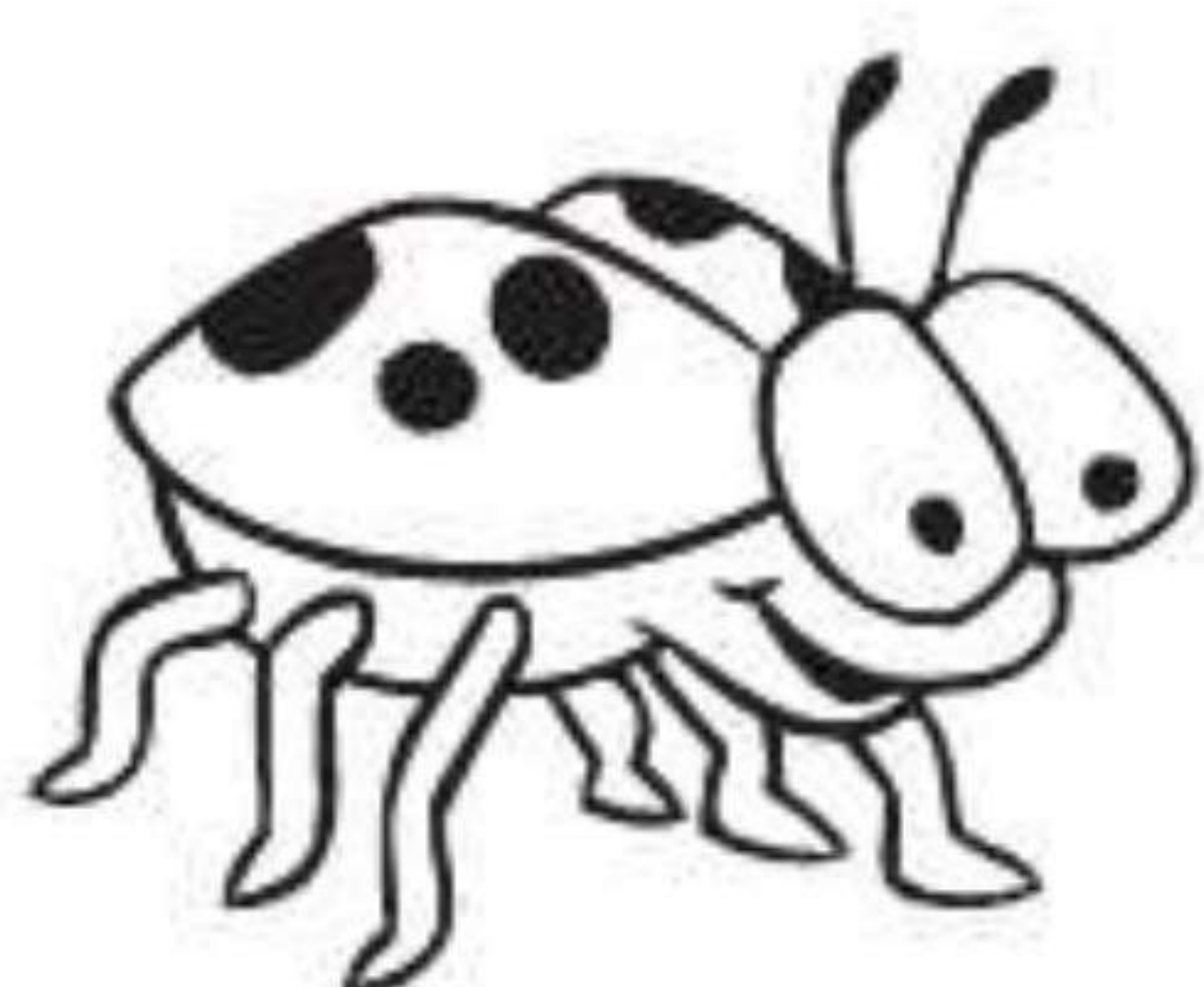

2●



●3

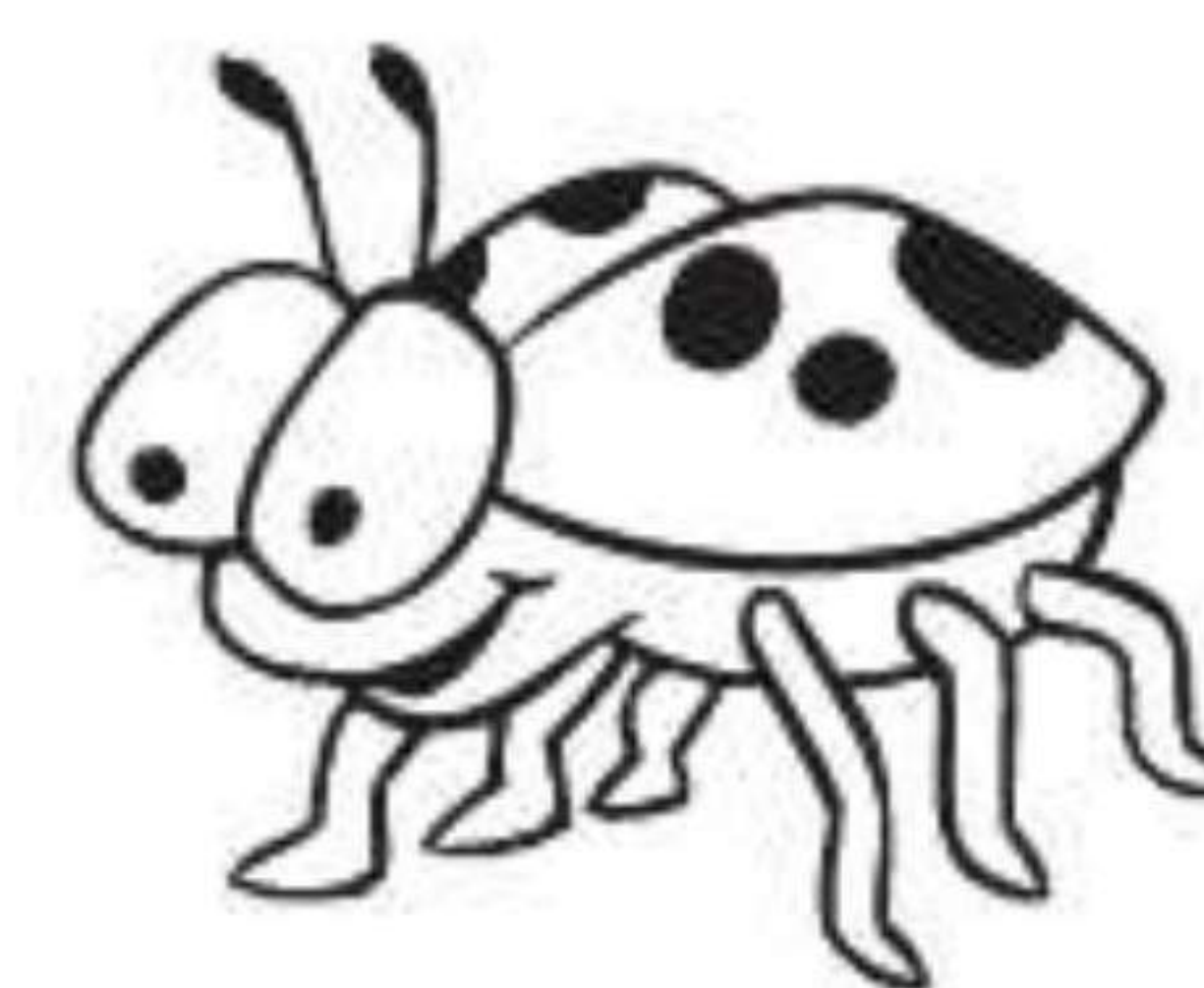

●4

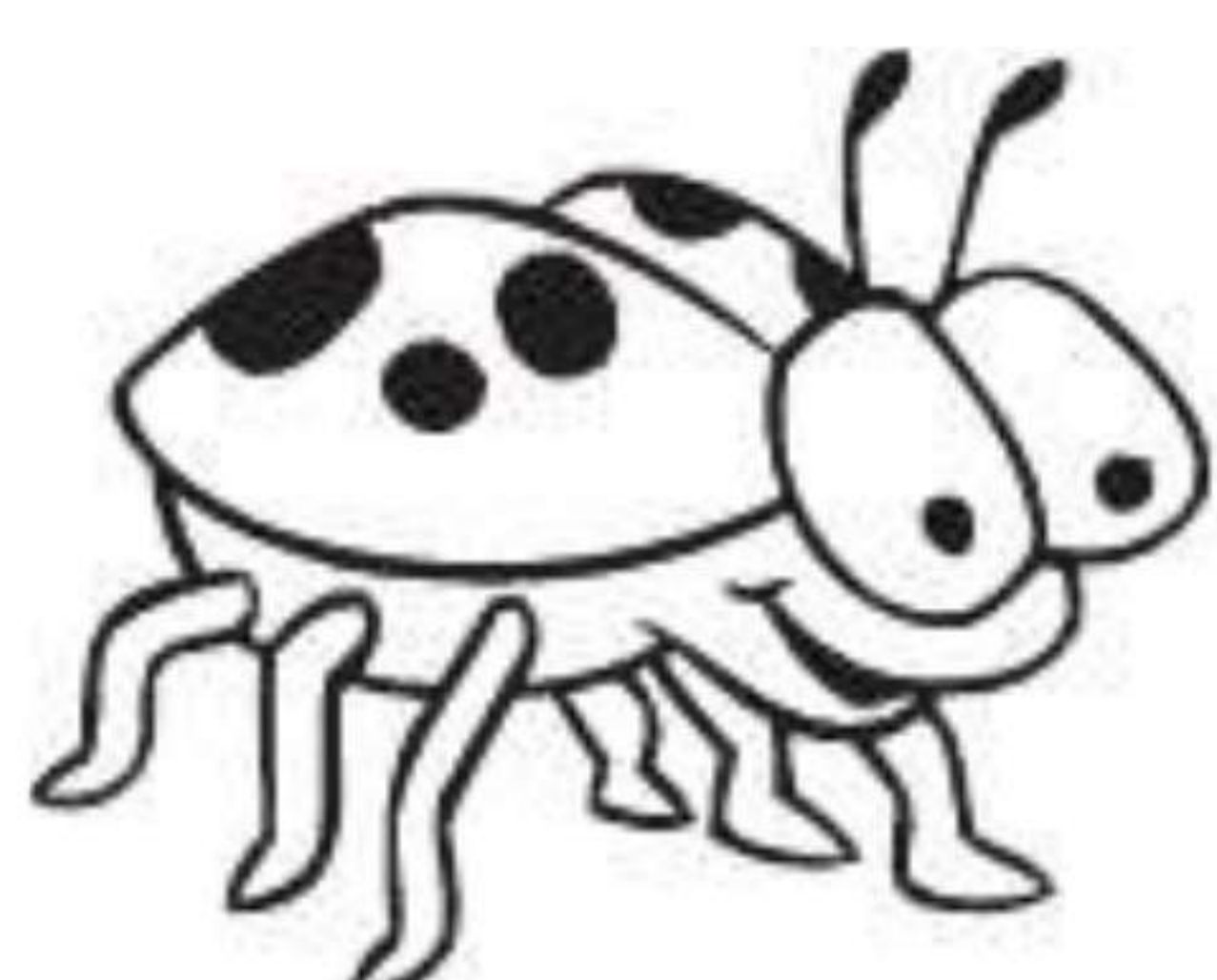
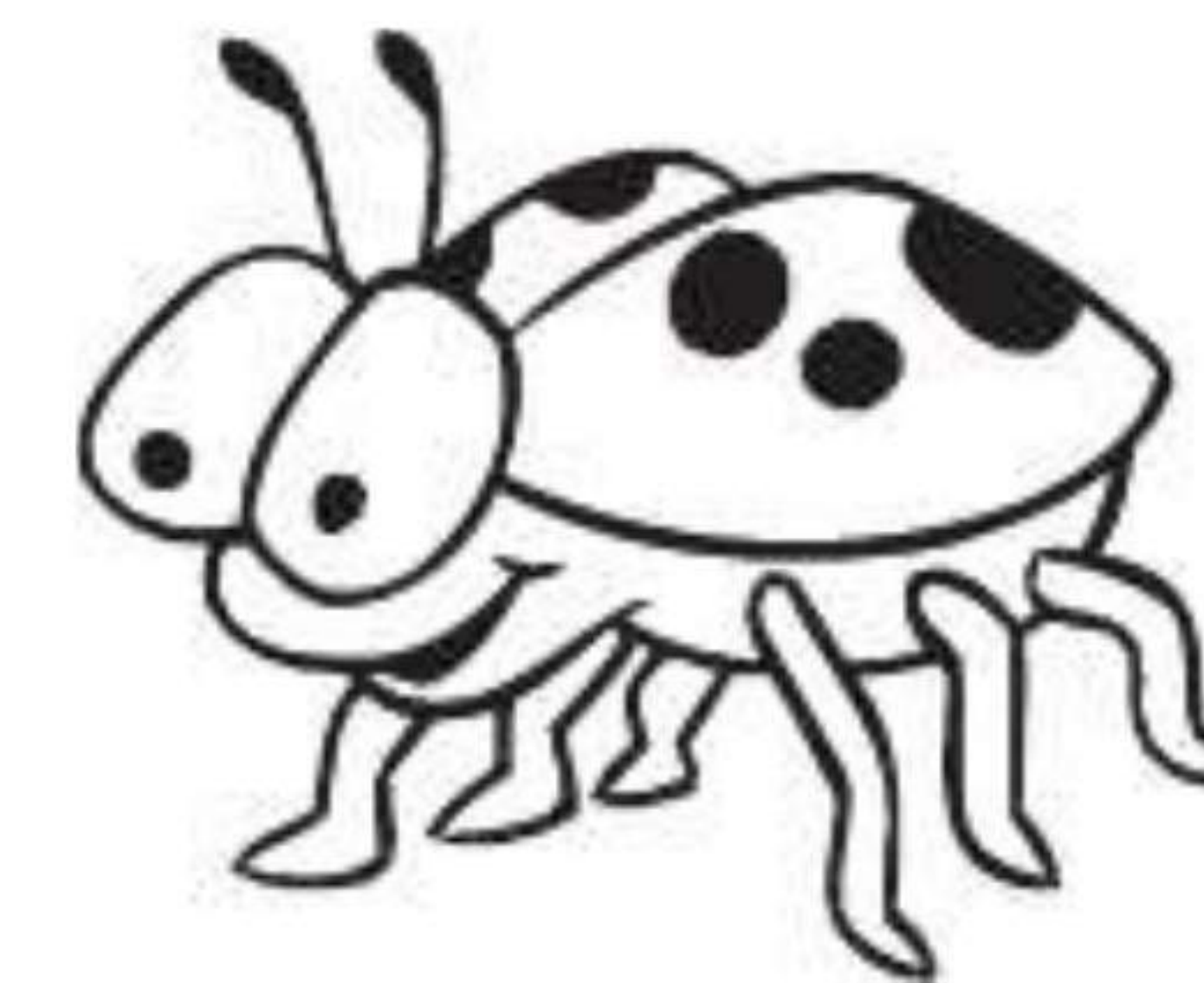
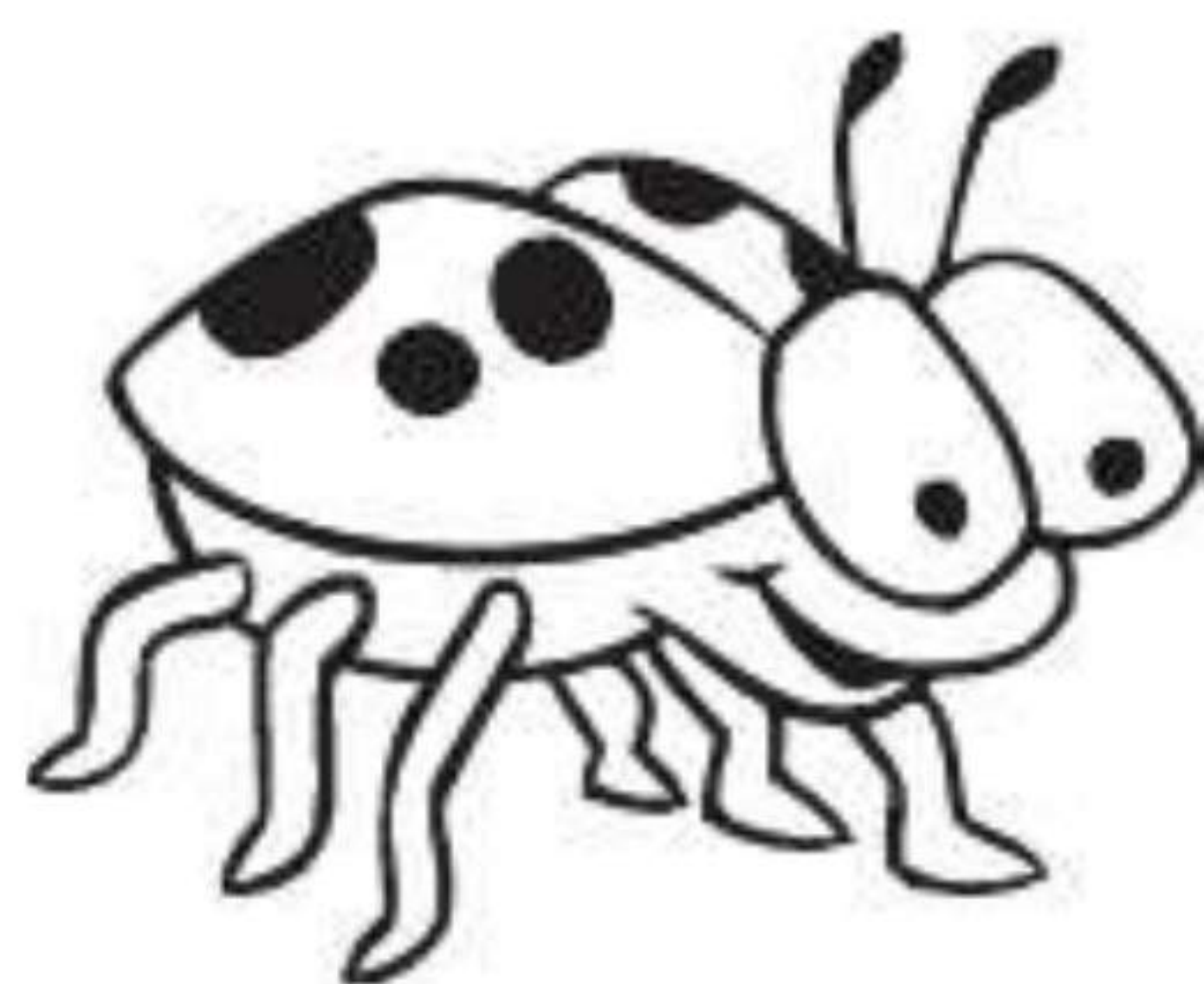
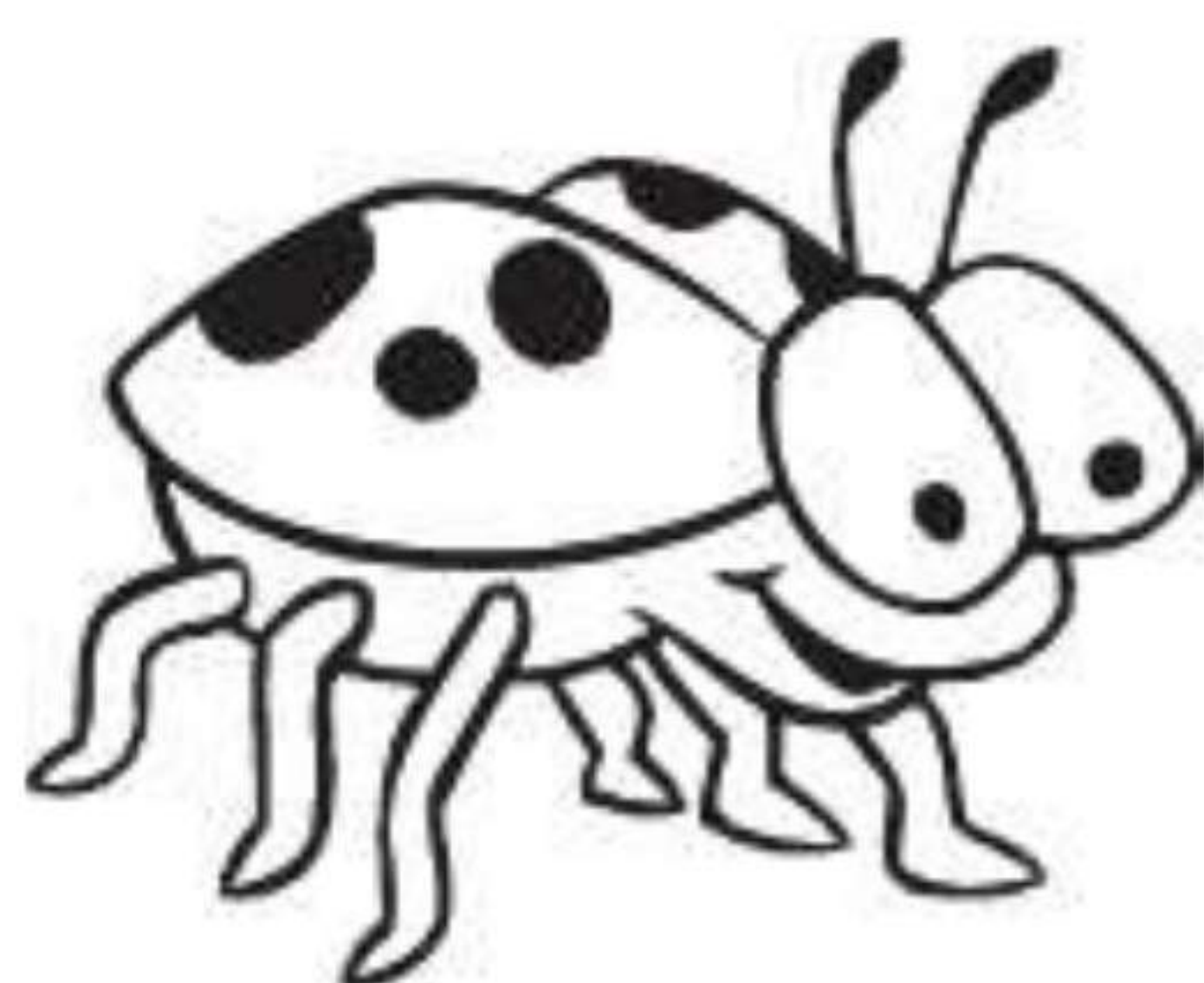

6●

●5

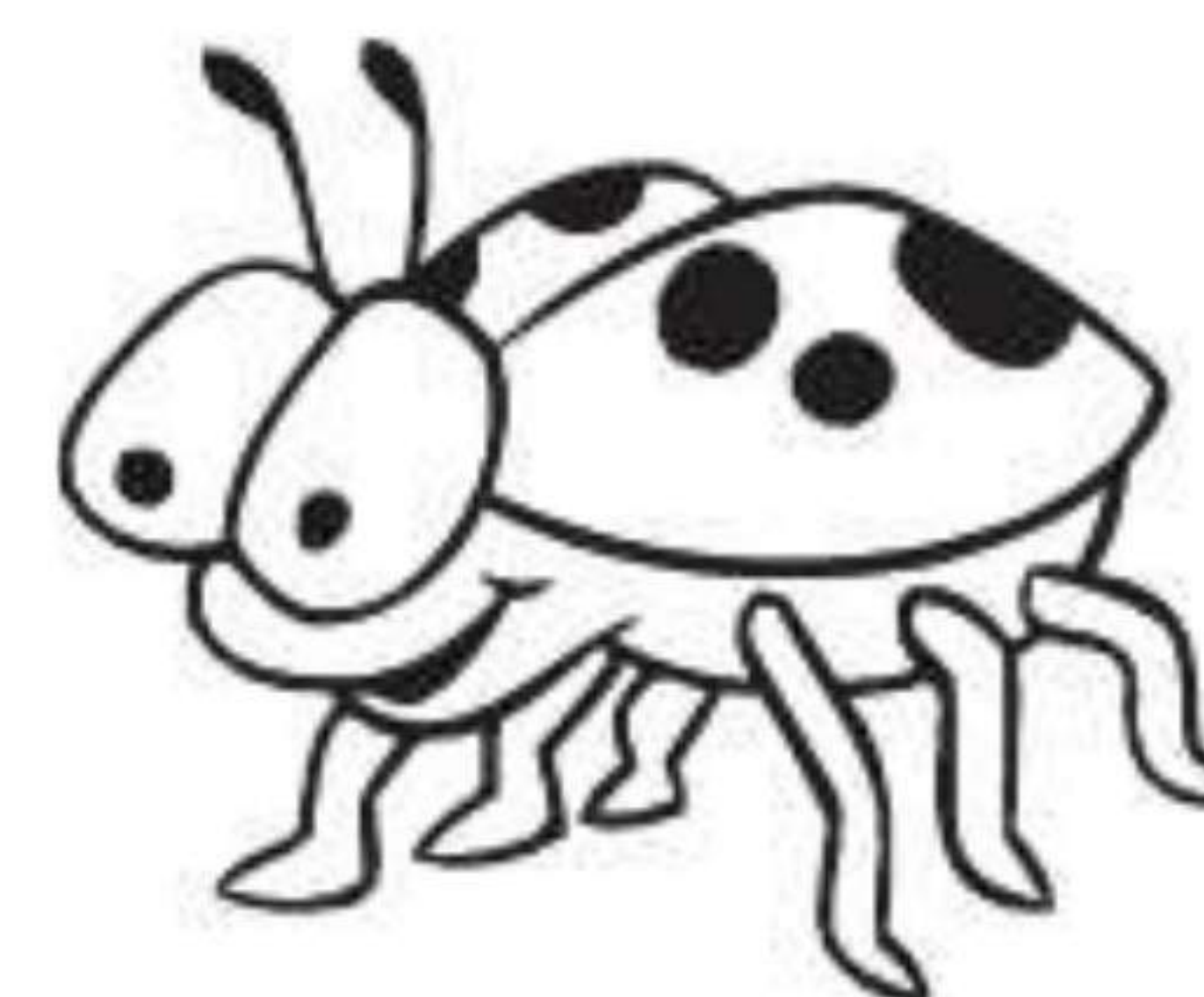



Eight 8

Directions: Trace and write the number 8. Then, draw eight peas on the plate.

Tracing practice area with three sets of horizontal lines (top blue, middle dashed red, bottom blue). The first set contains a solid number 8 with arrows showing stroke direction, a dashed number 8 for tracing, and two dots for starting points. The second and third sets are blank for independent practice.

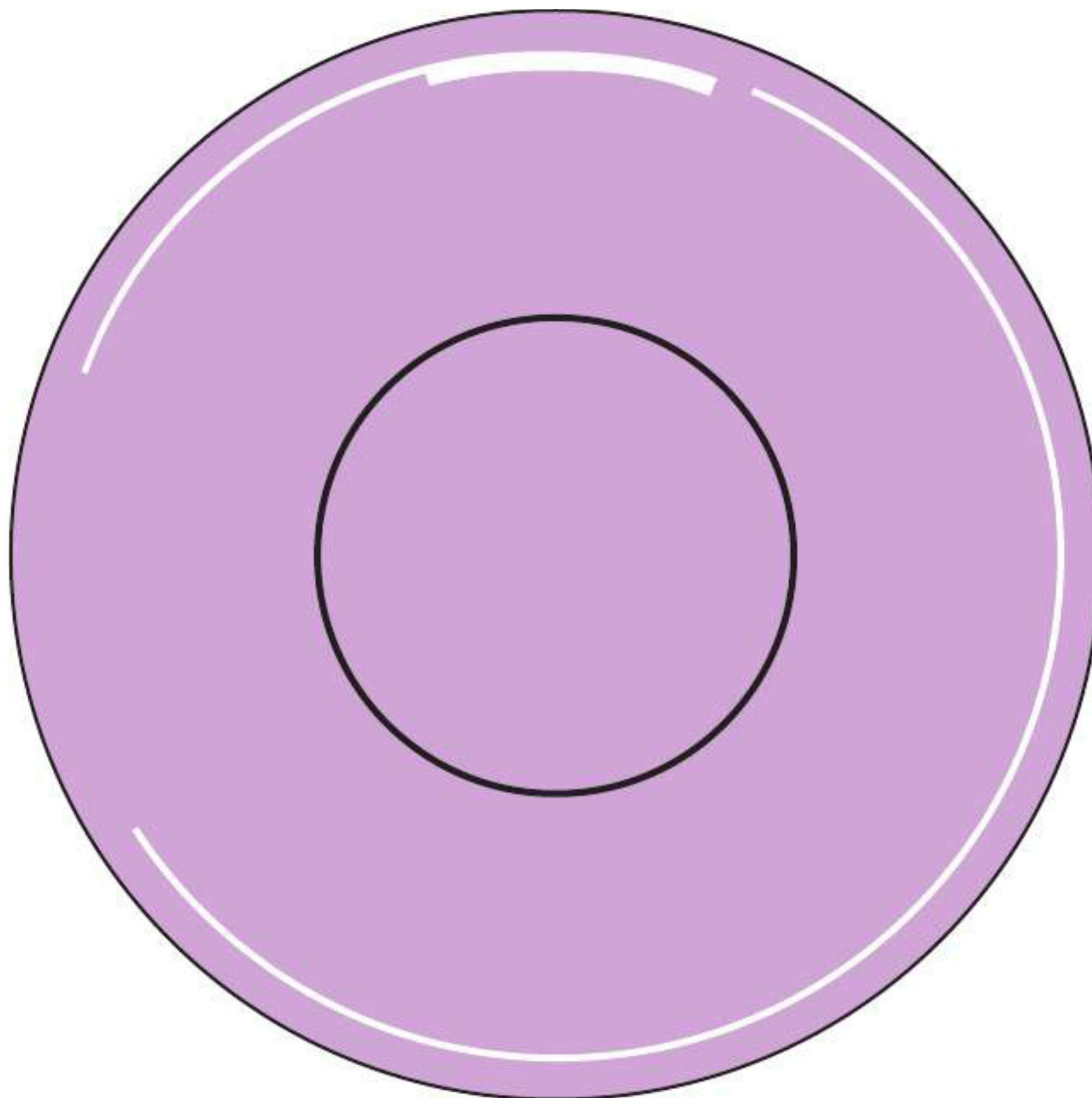



Eight 8

Directions: Trace and write the word **eight**. Then, color the pictures that have eight spots.

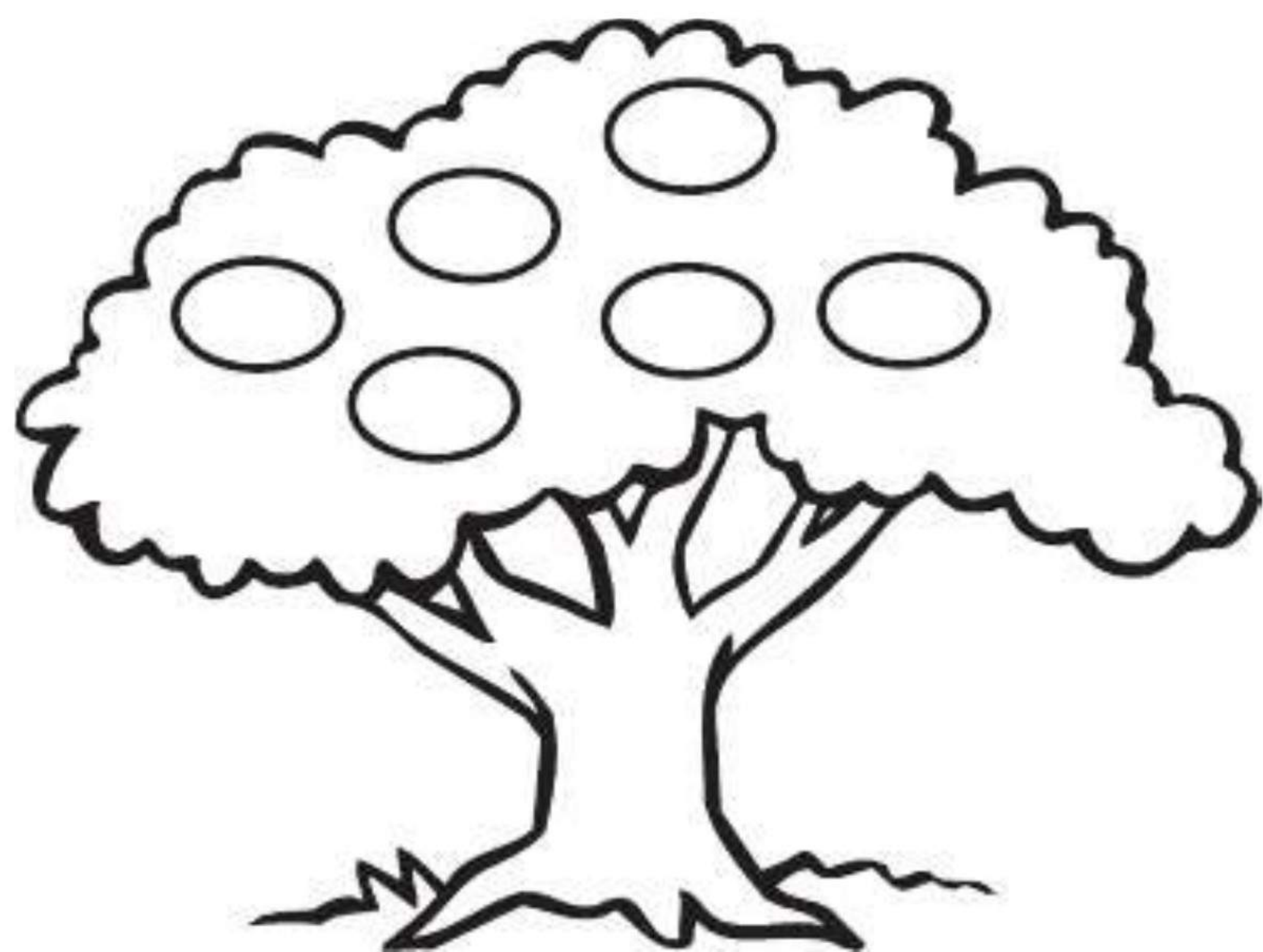
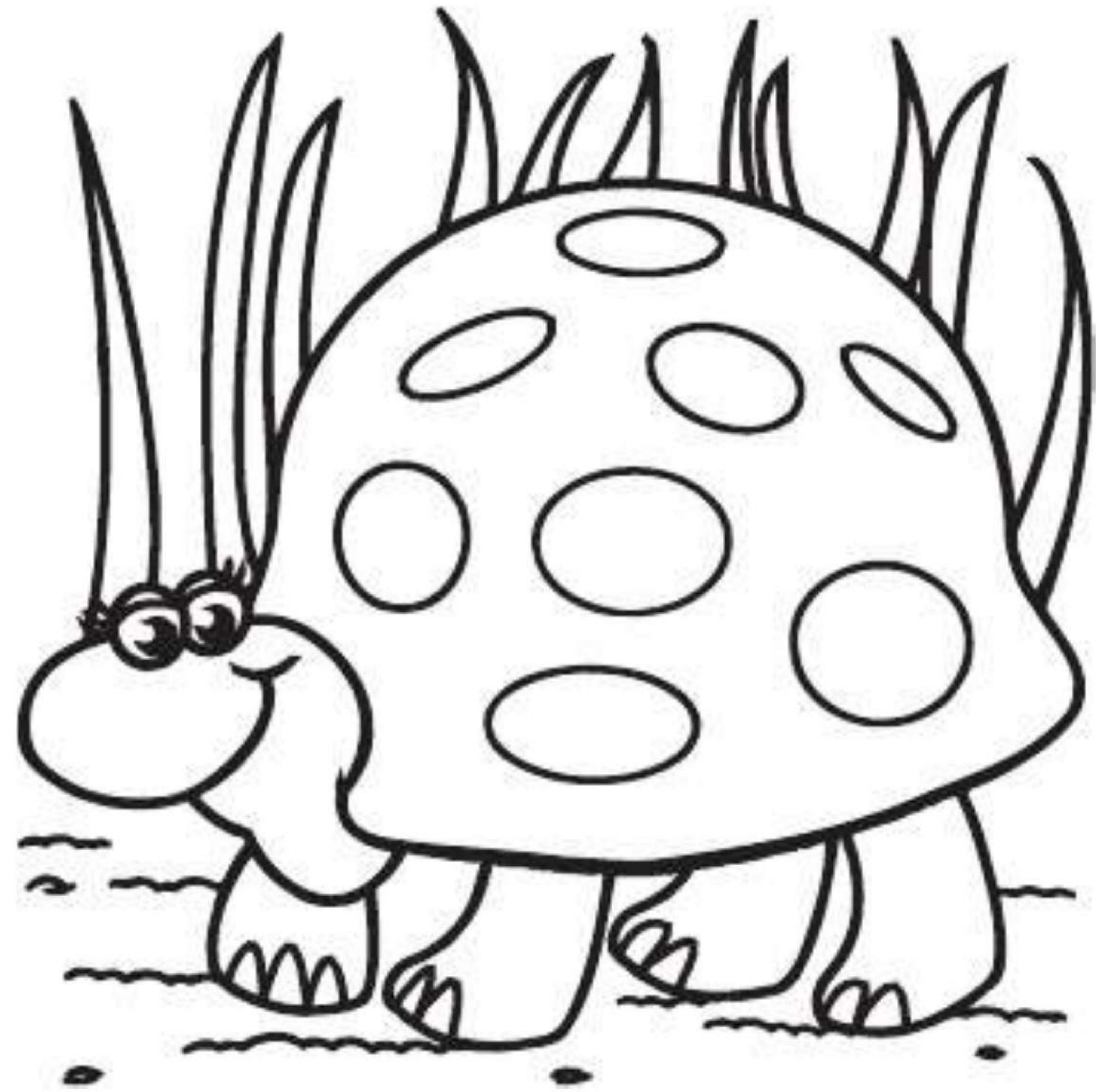



Nine and Ten 9, 10

Directions: Trace and write the numbers 9 and 10. Then, count and write the correct number.

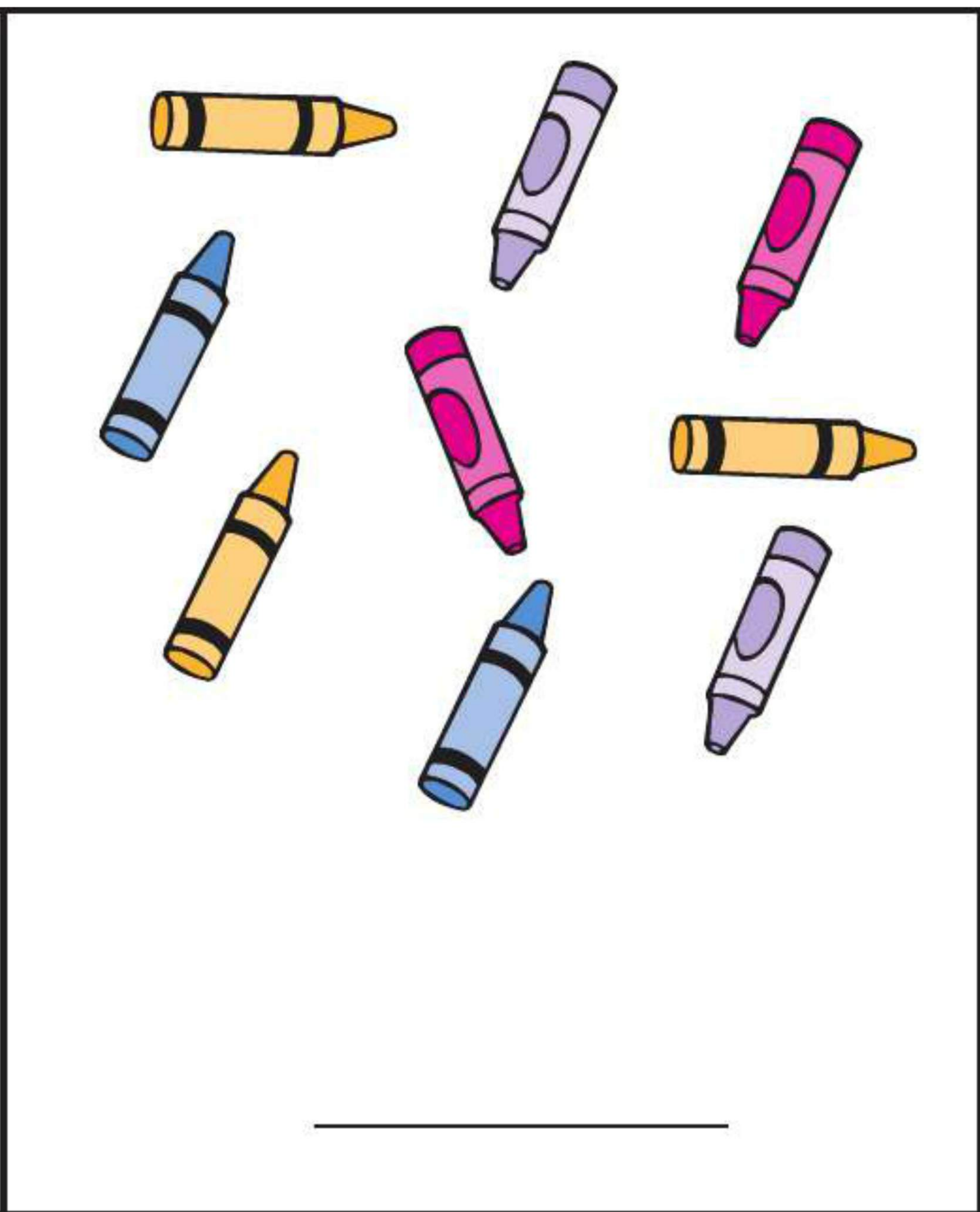
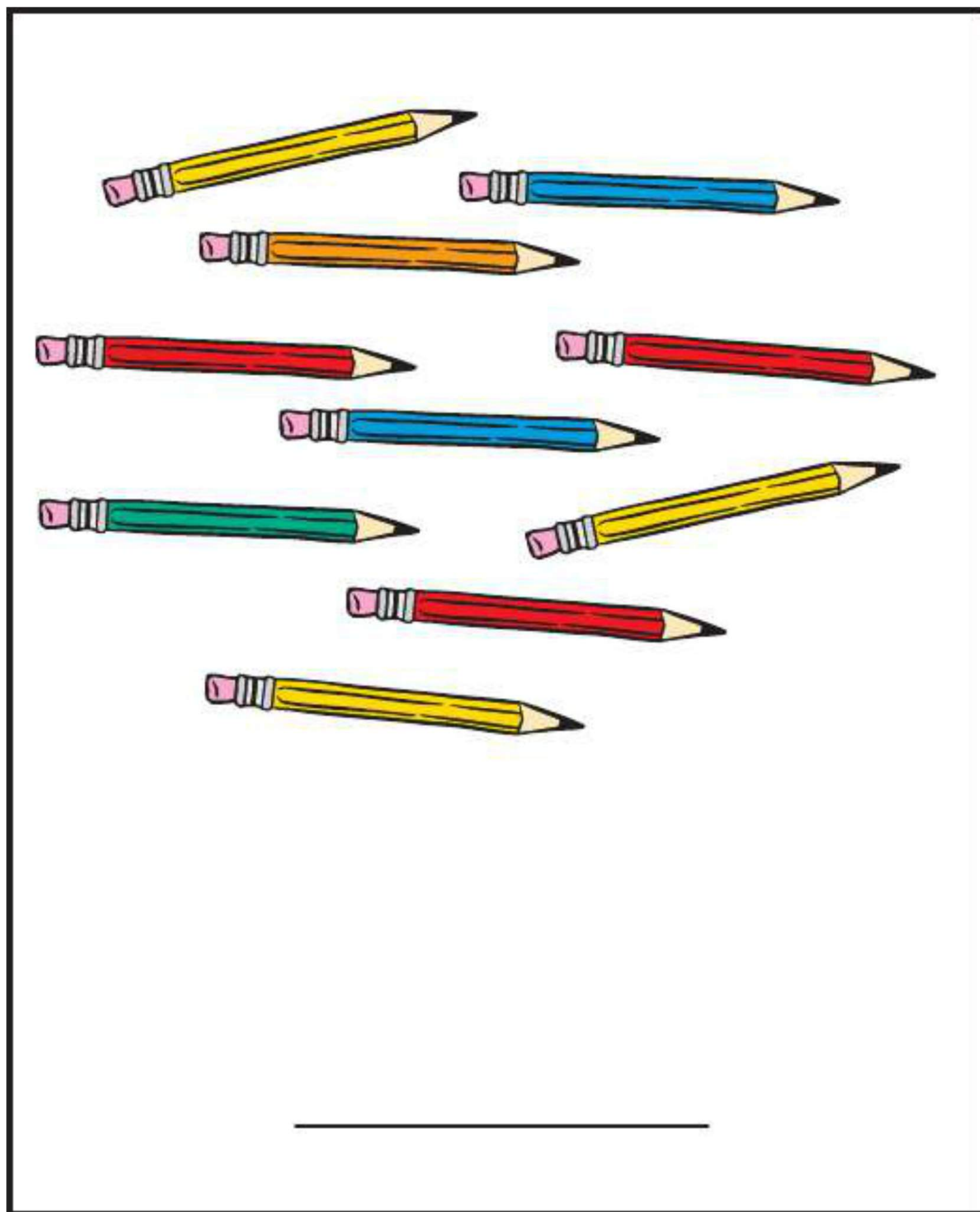
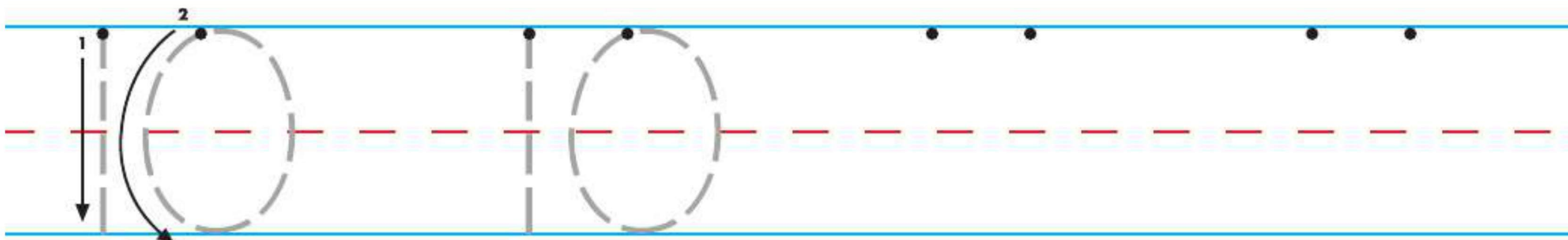
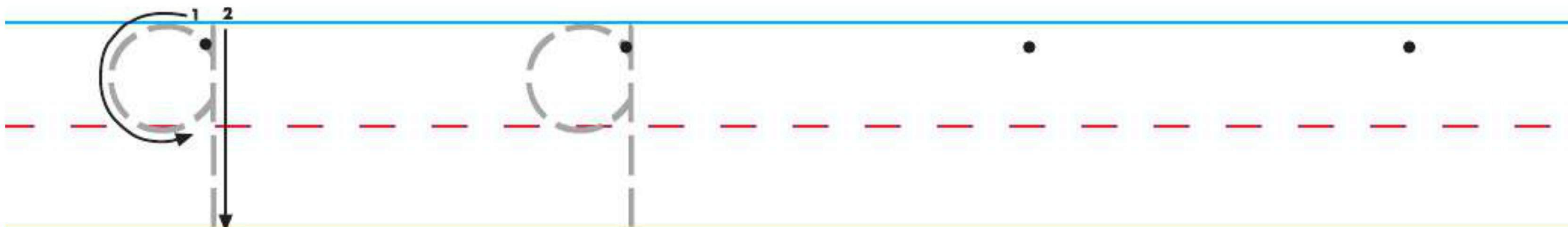



Nine 9

Directions: Trace and write the word **nine**. Count the shapes on each quilt square below. Color the squares with nine shapes **green**. Color the other squares **yellow**.

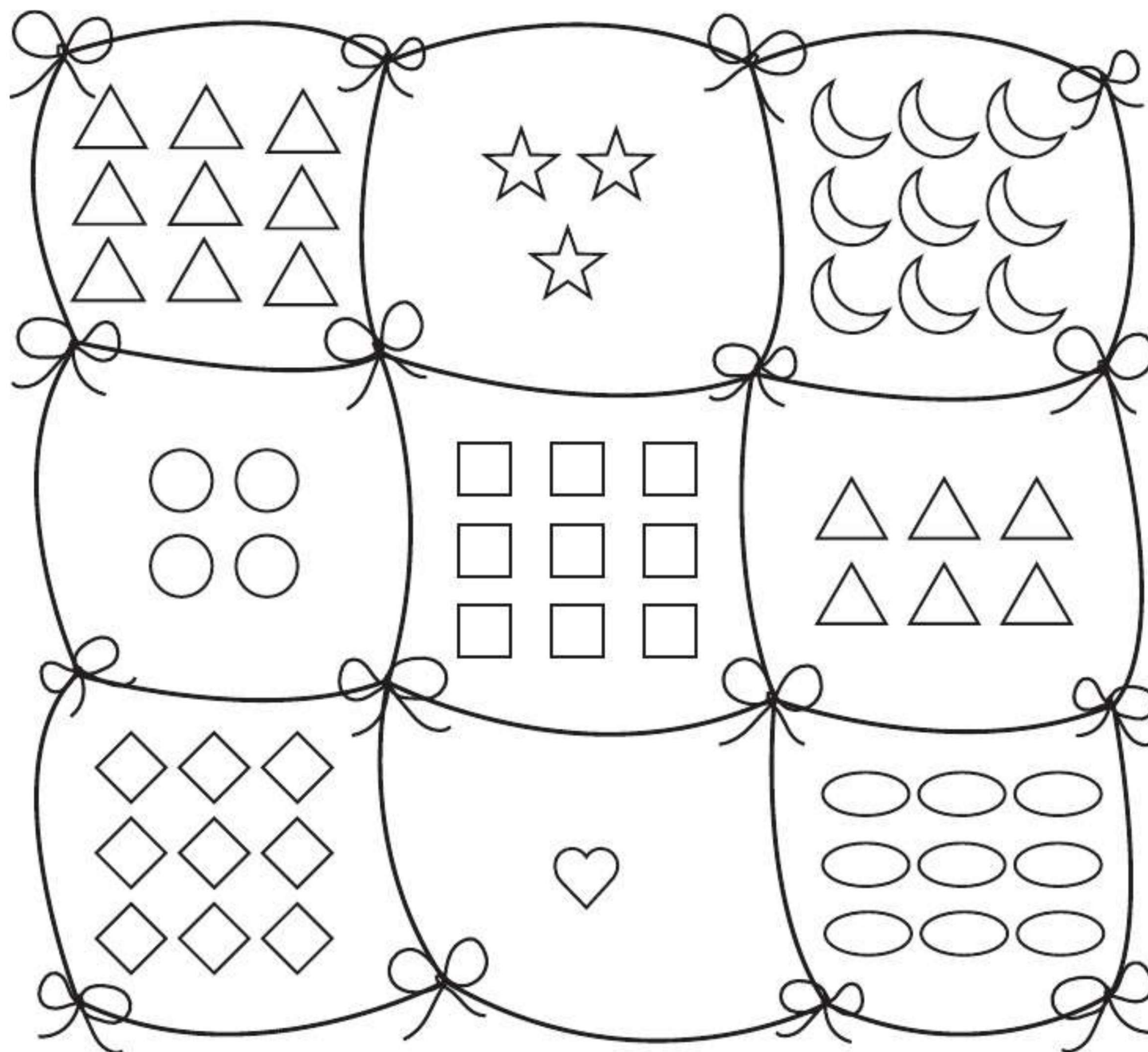
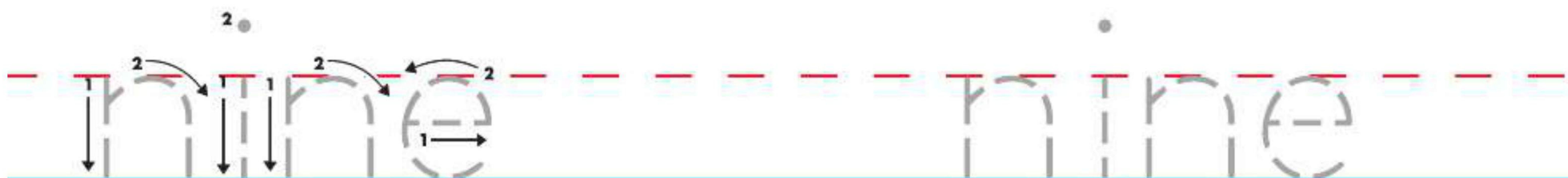



Ten 10

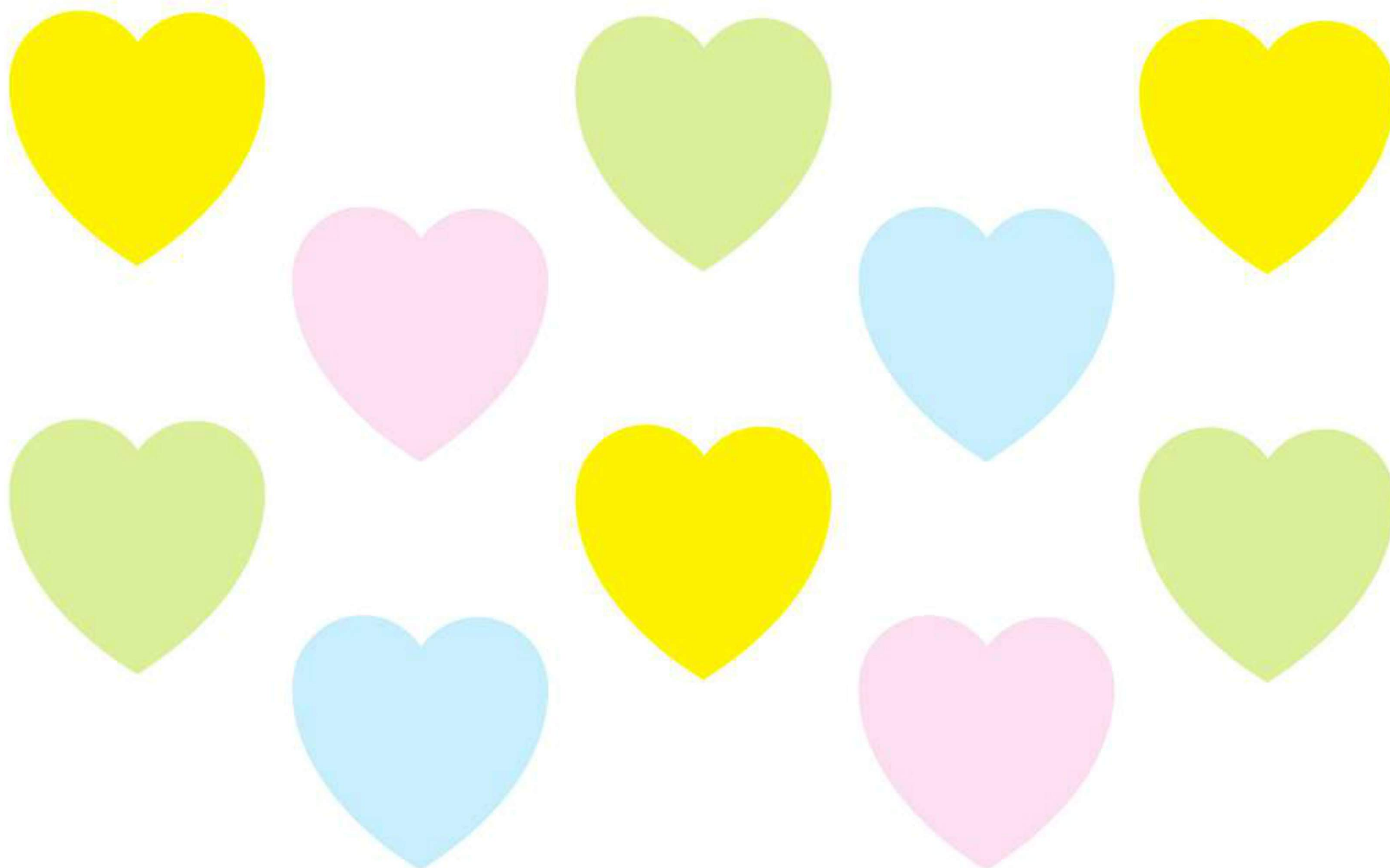
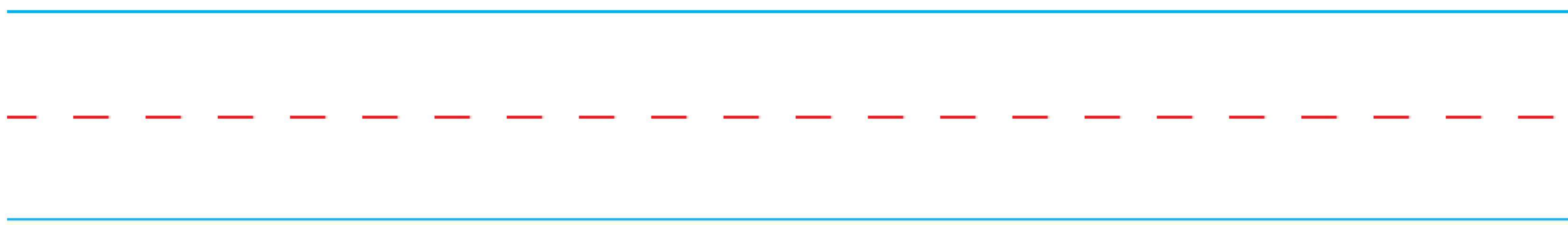
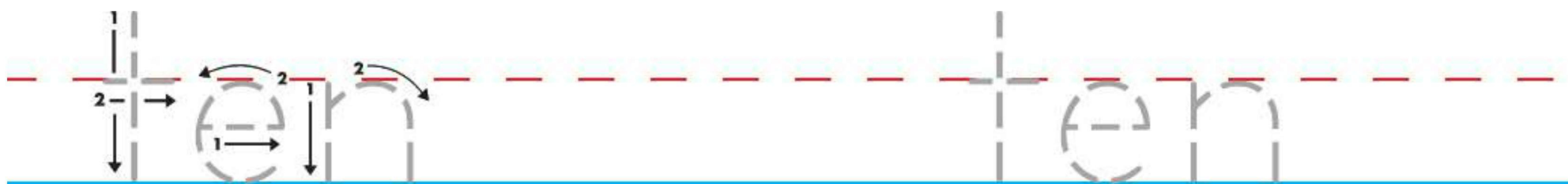

Directions: Trace and write the word **ten**. Then, write the numbers **1** to **10** on the empty hearts.



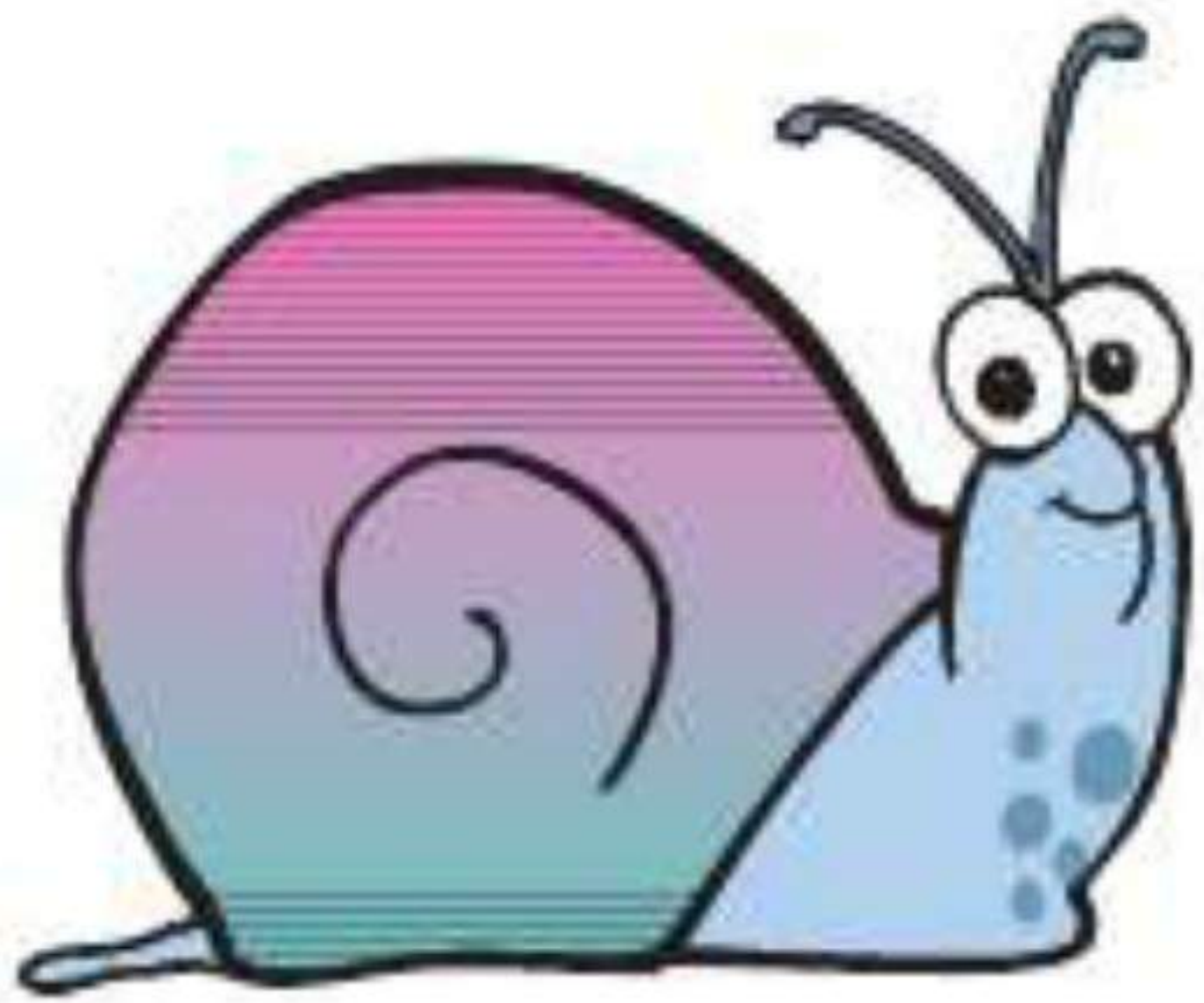
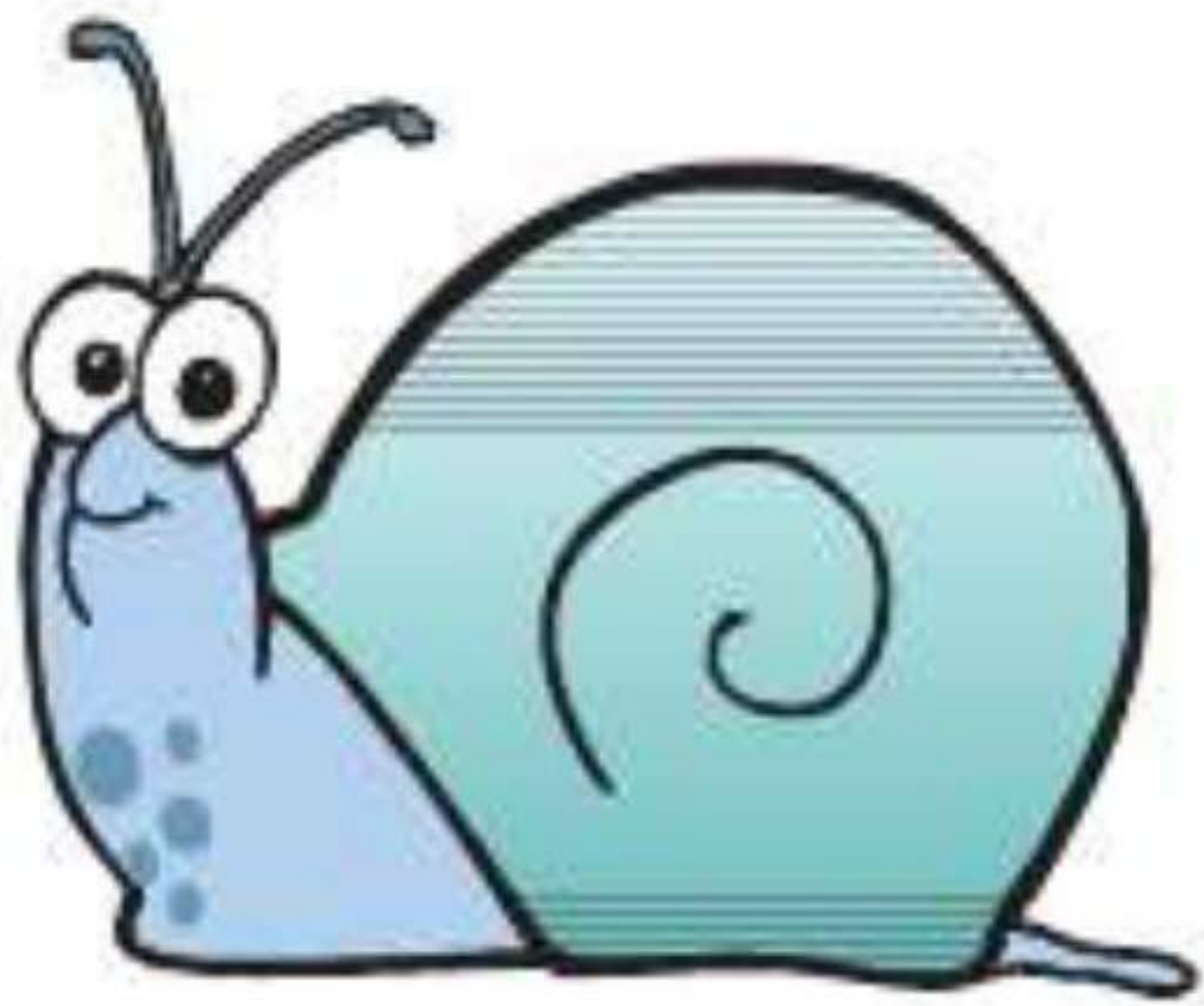
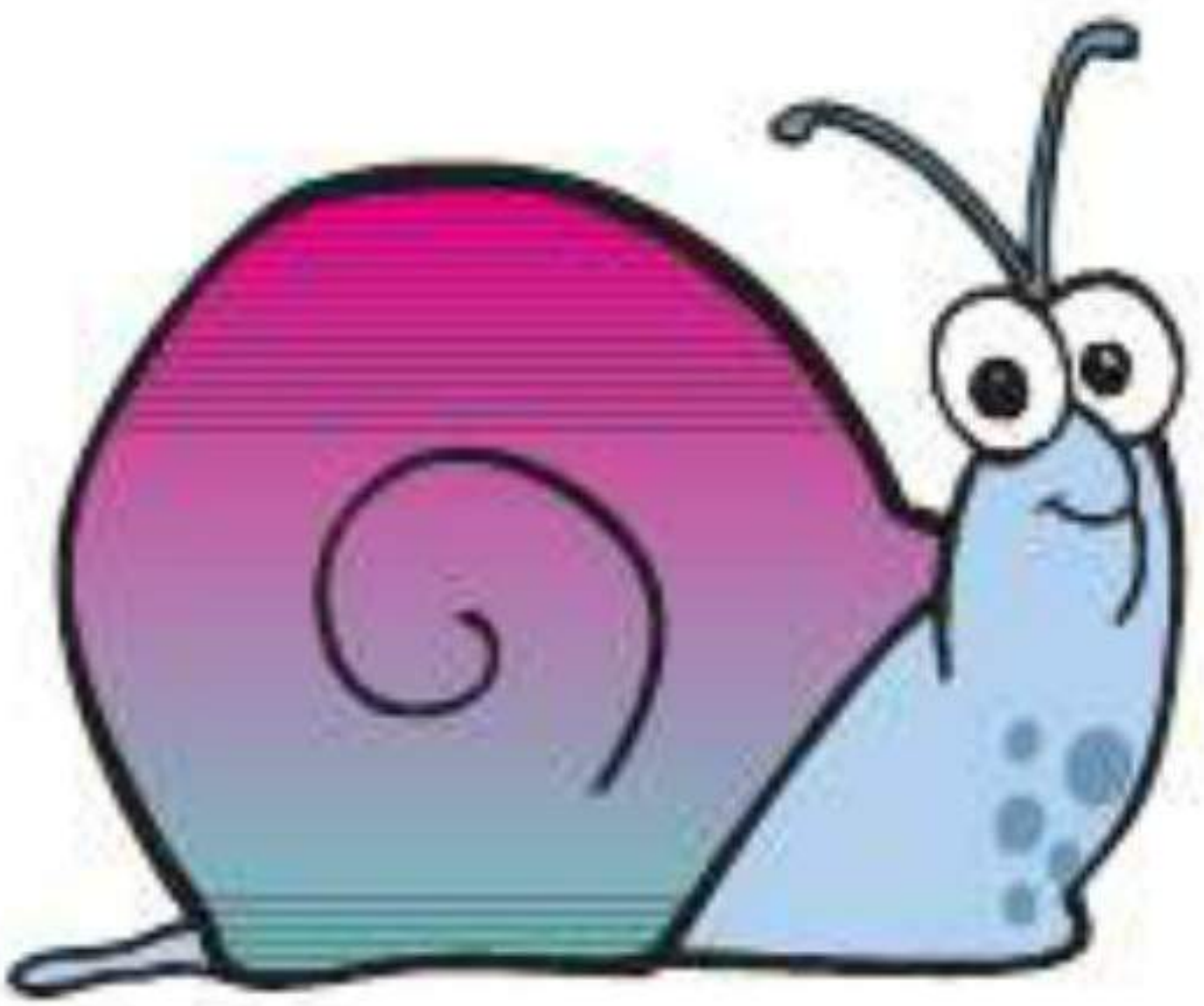
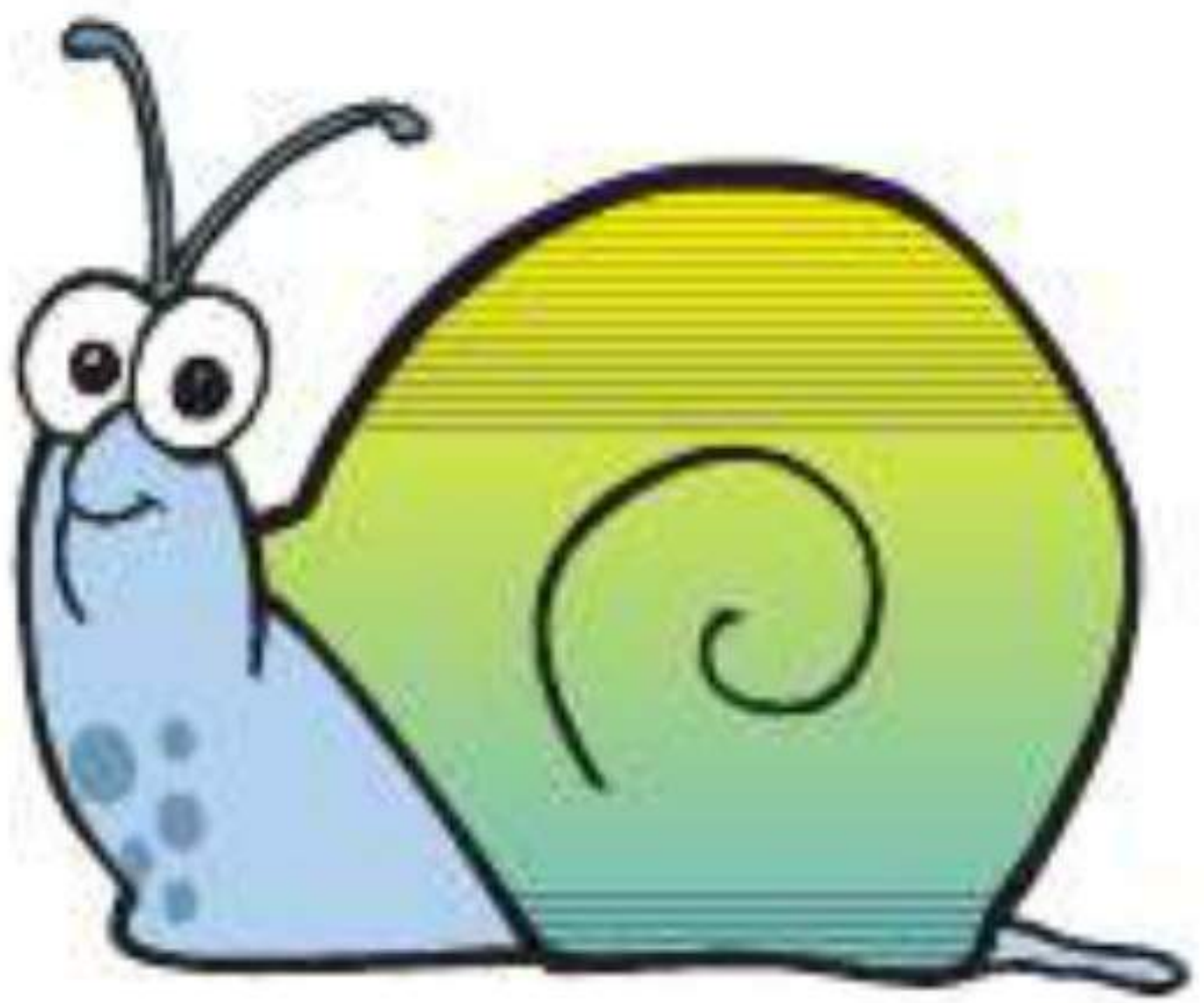
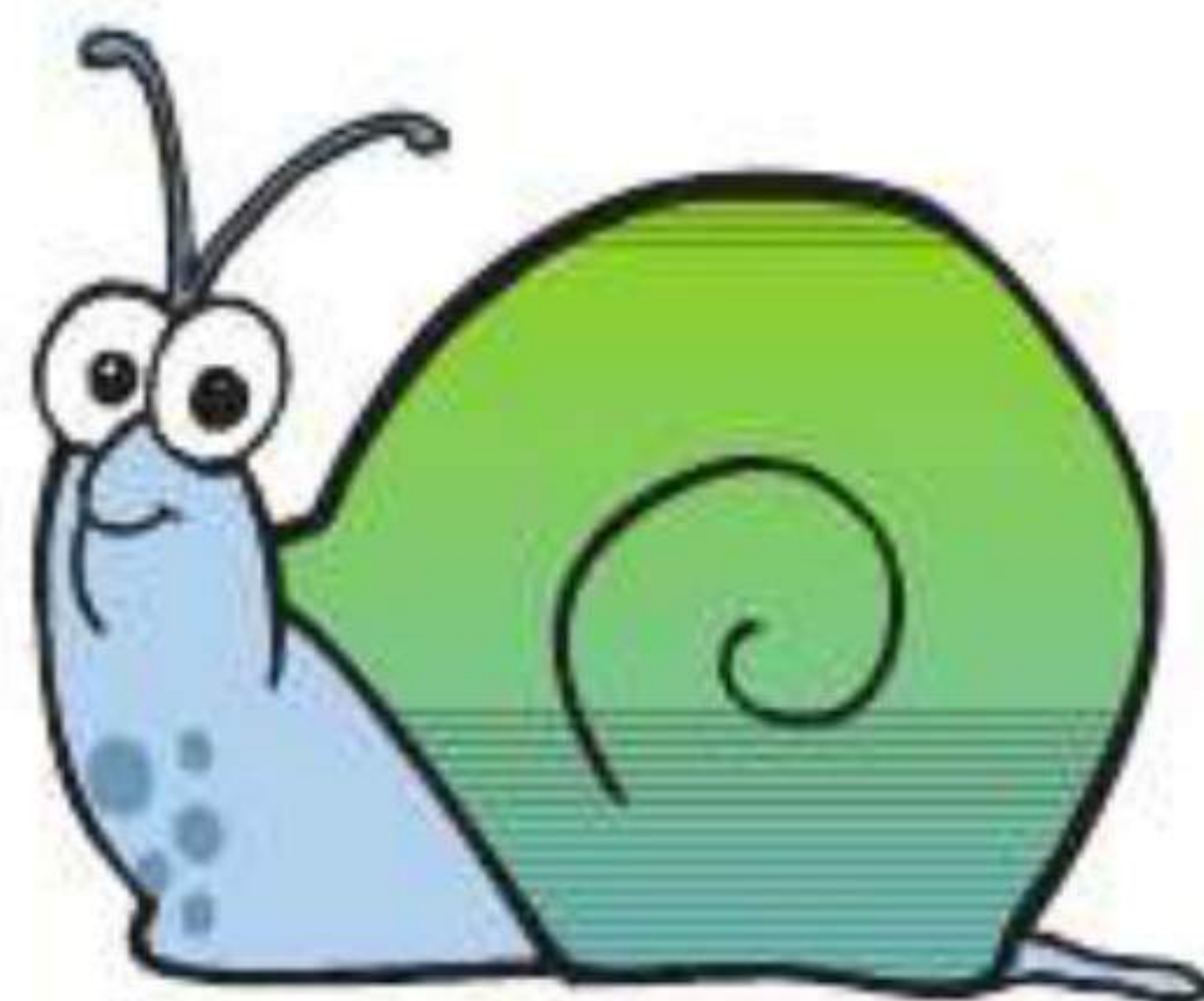
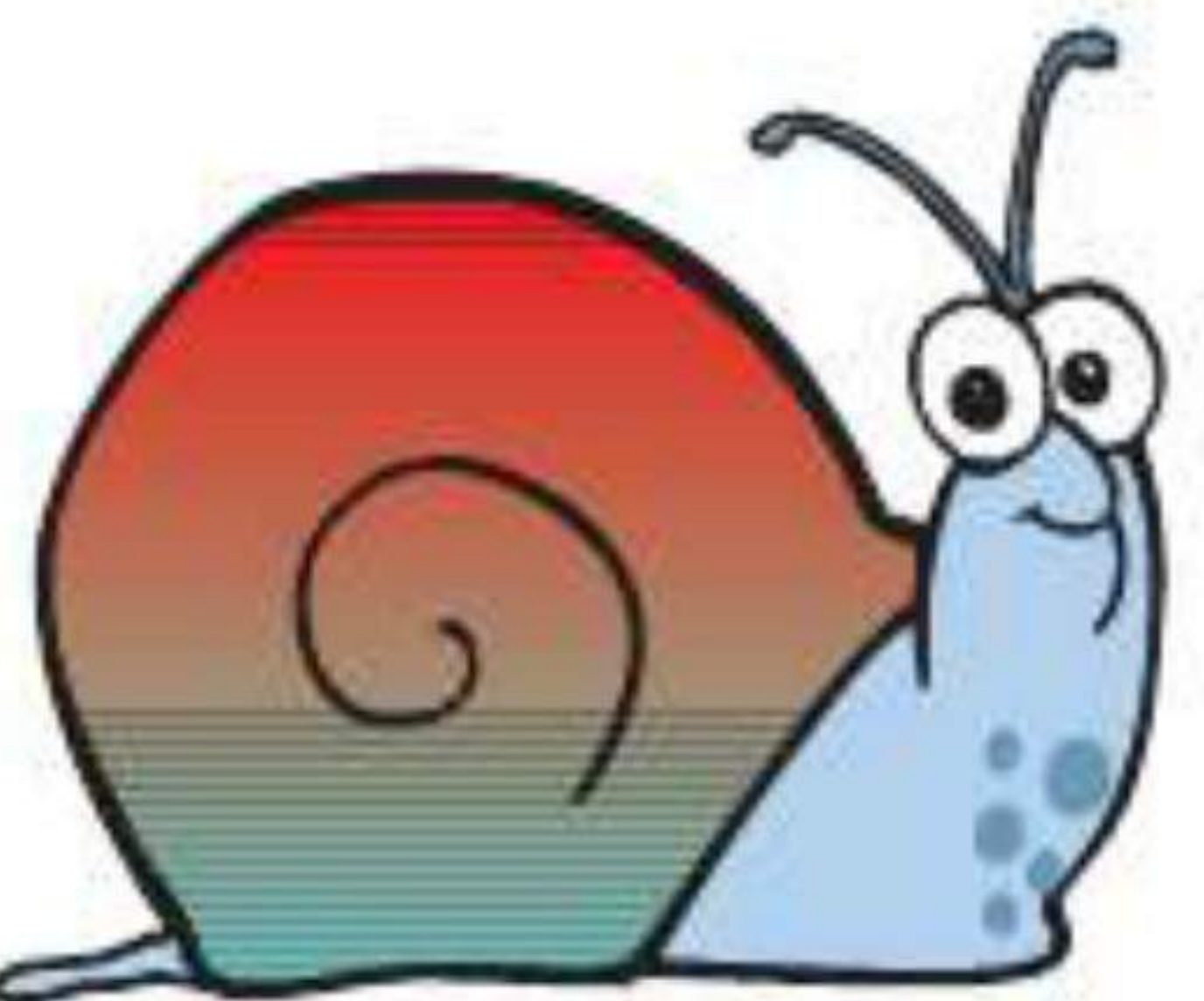
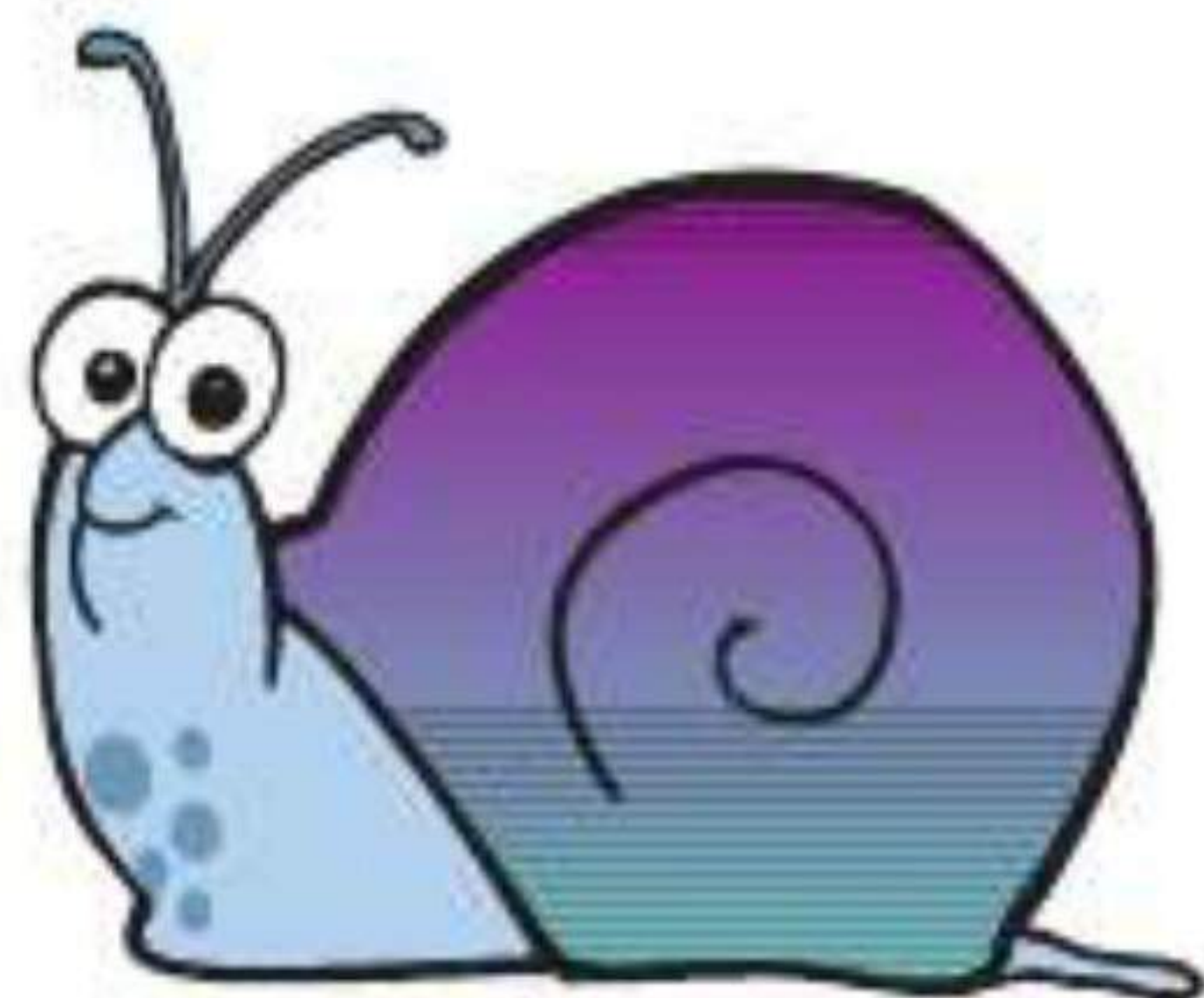

Review Numbers 7-10

Directions: Circle the correct number in each box.

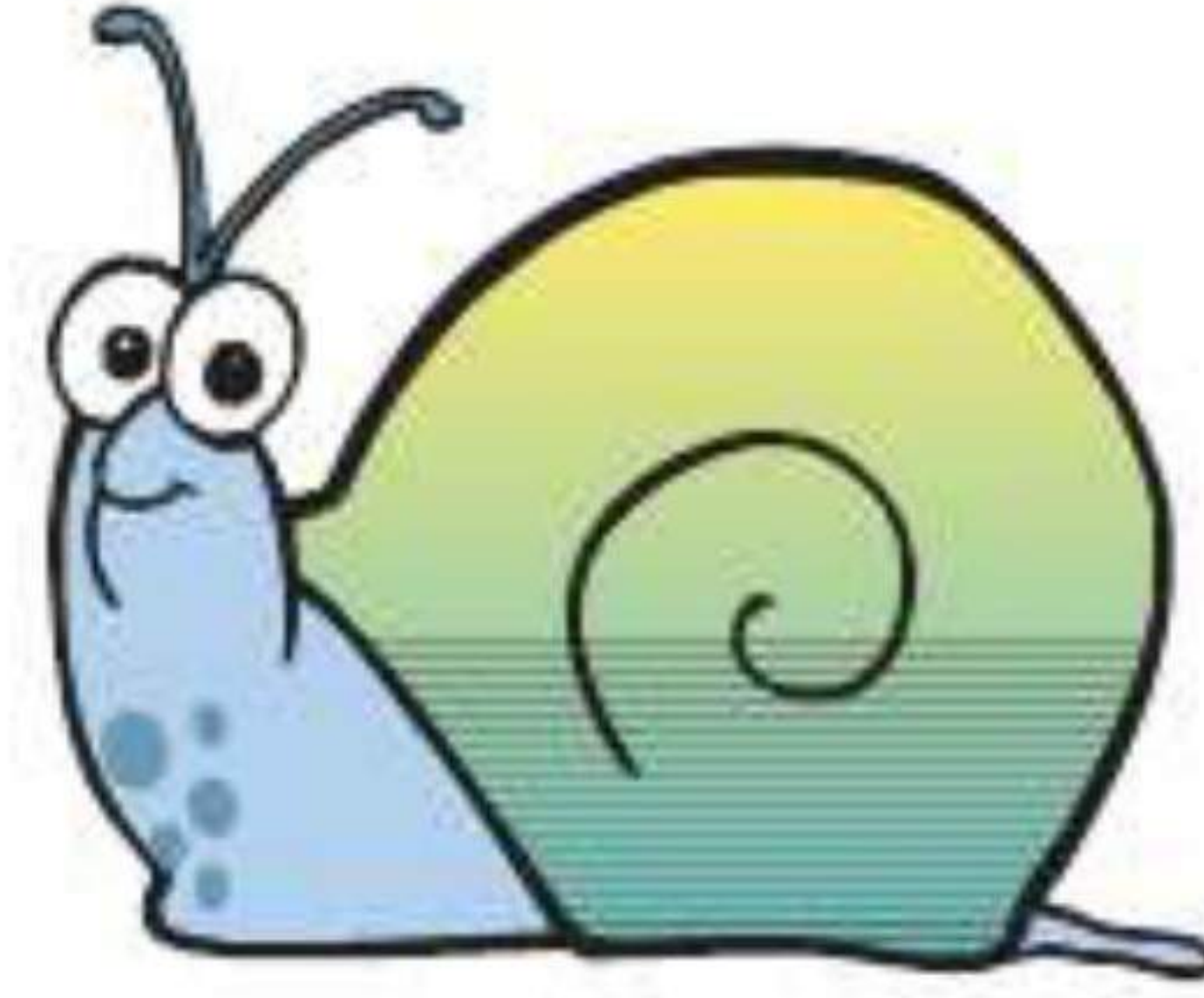
				
				
	7	8	9	

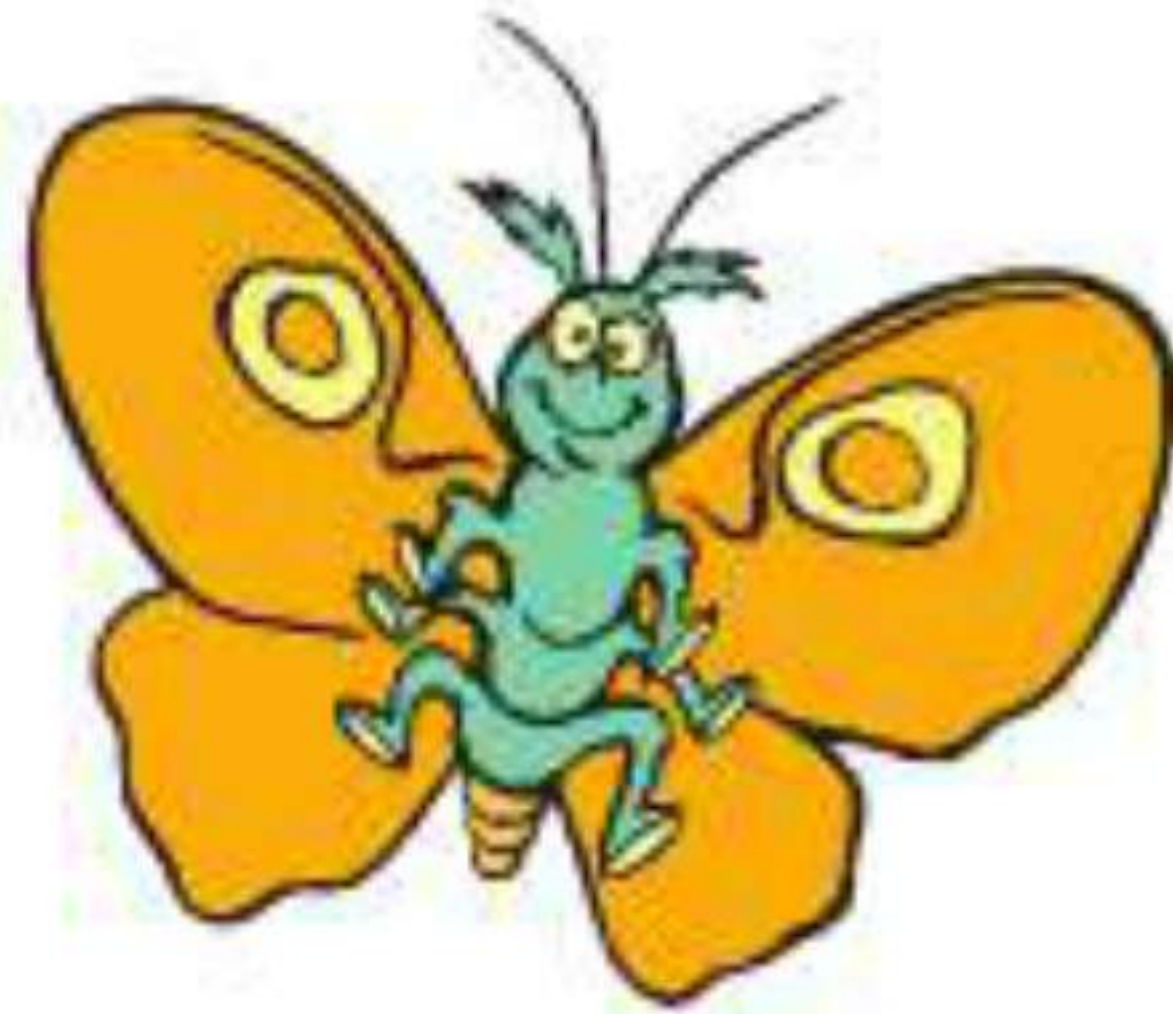
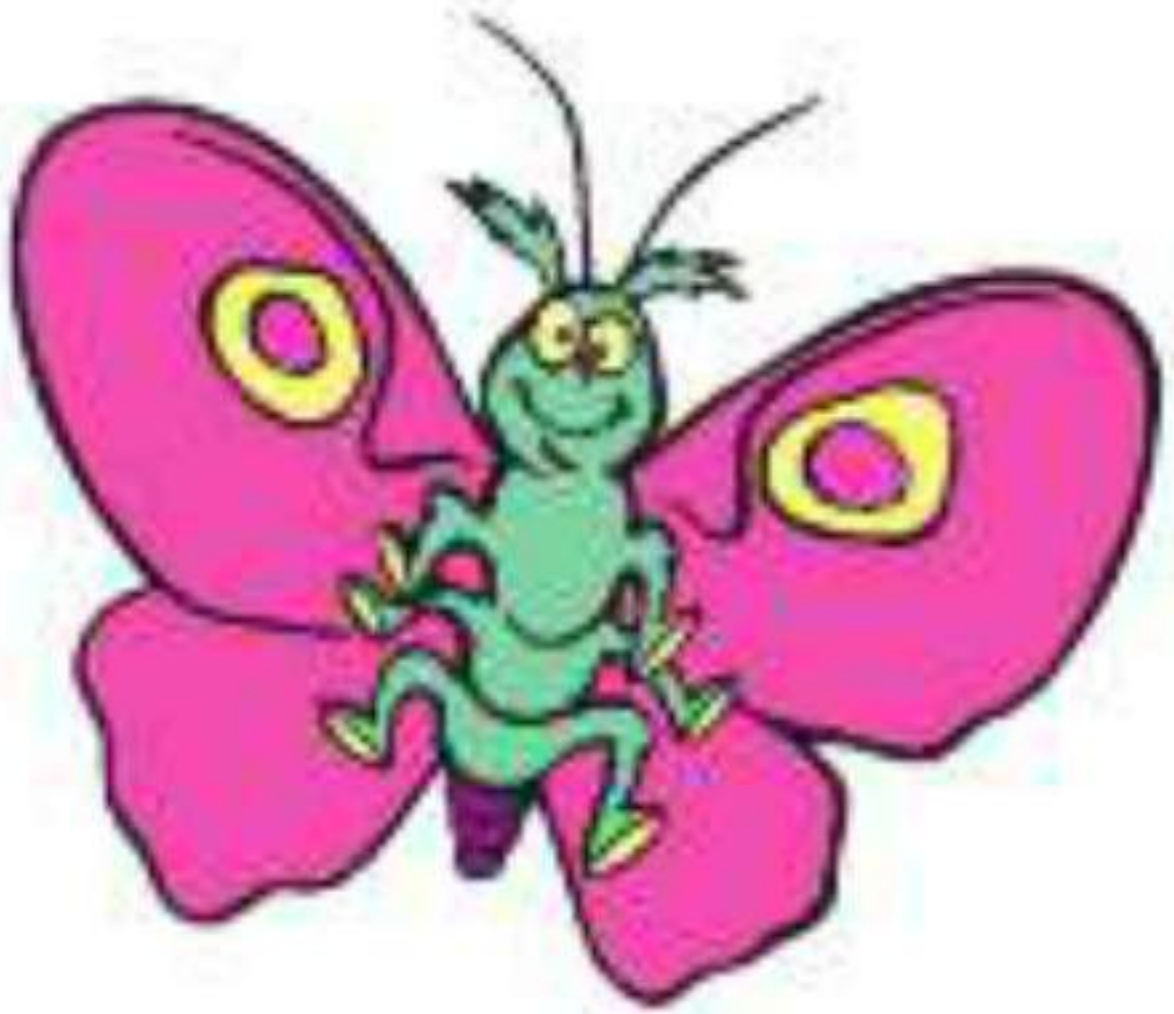
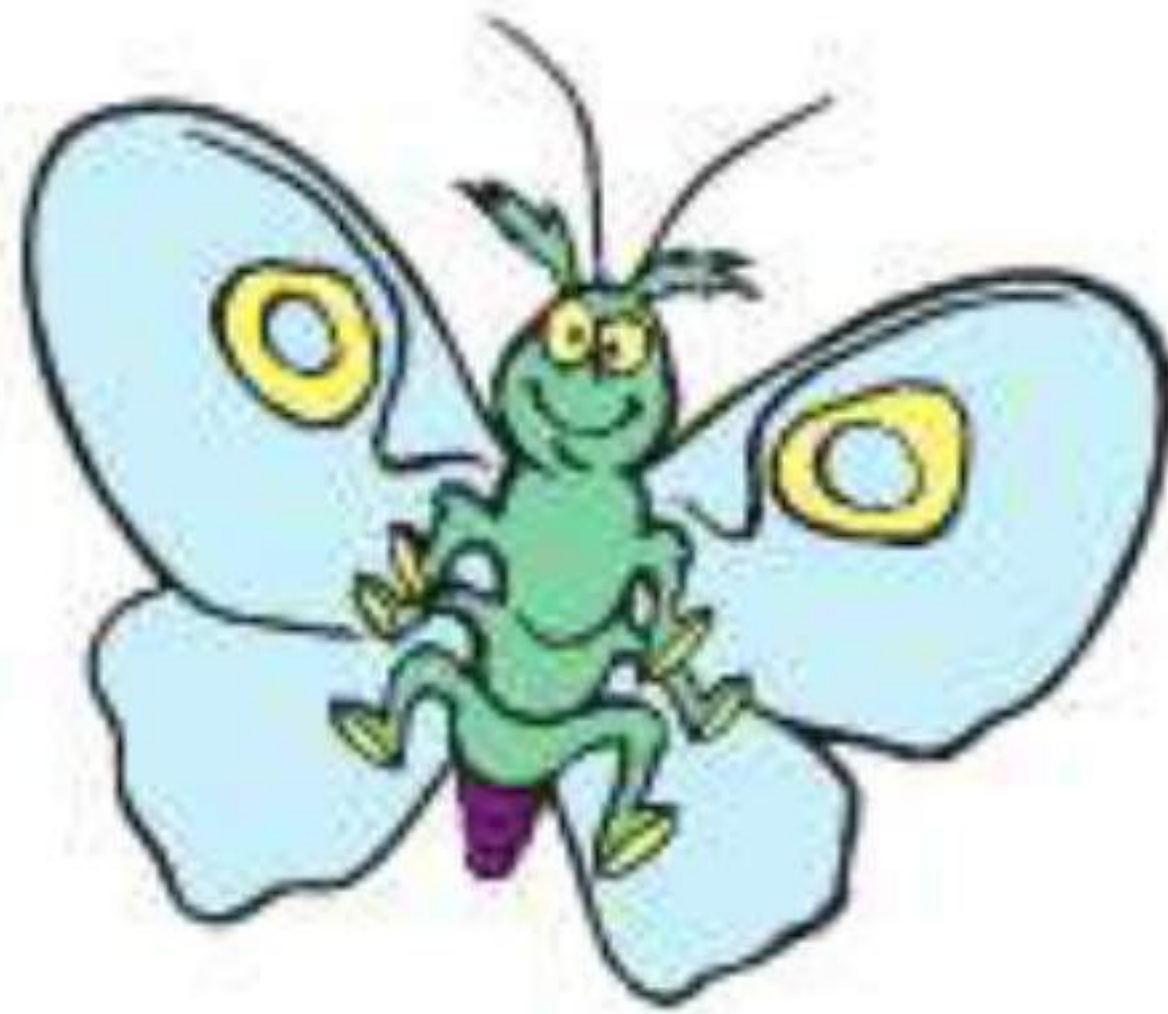
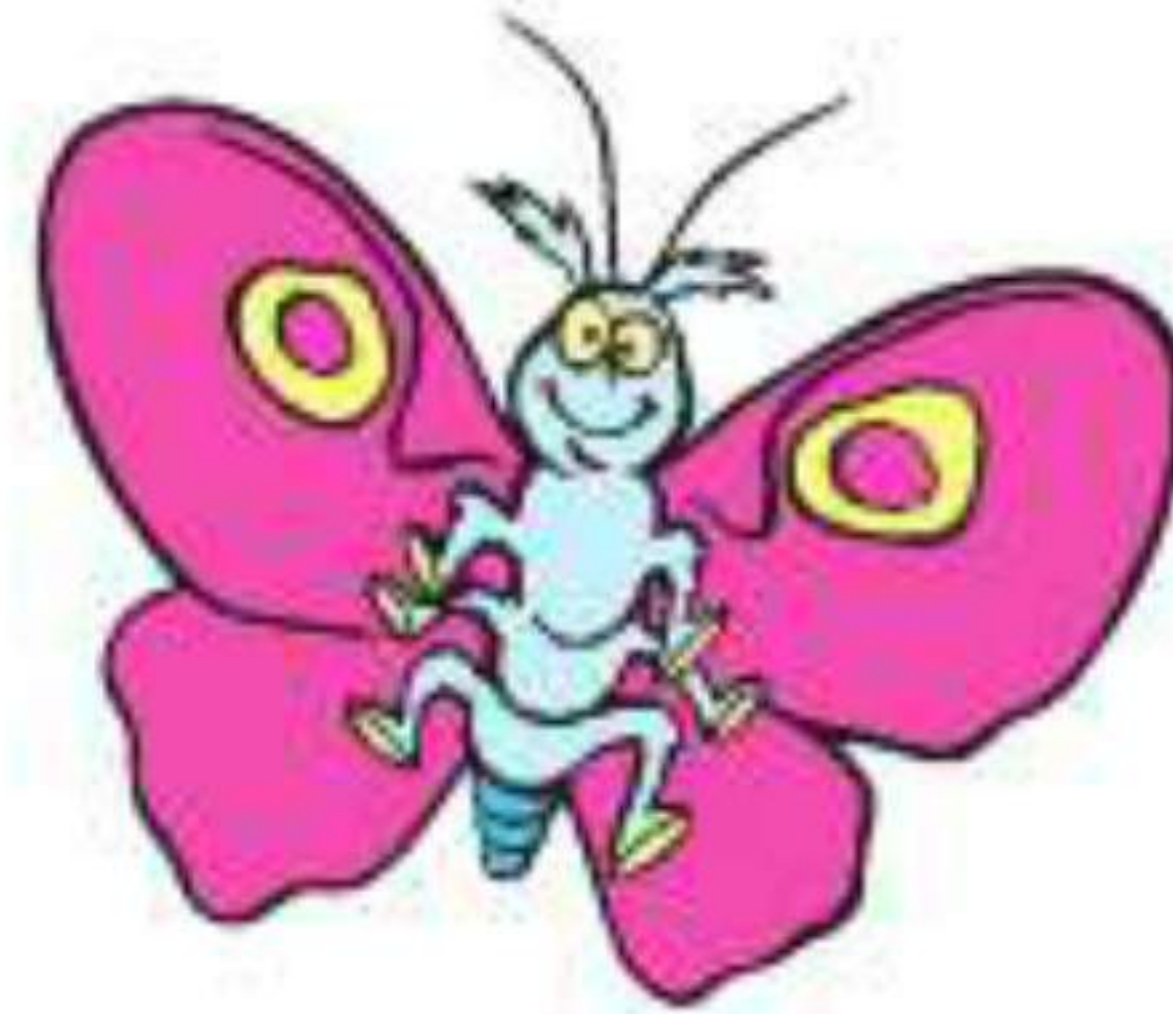
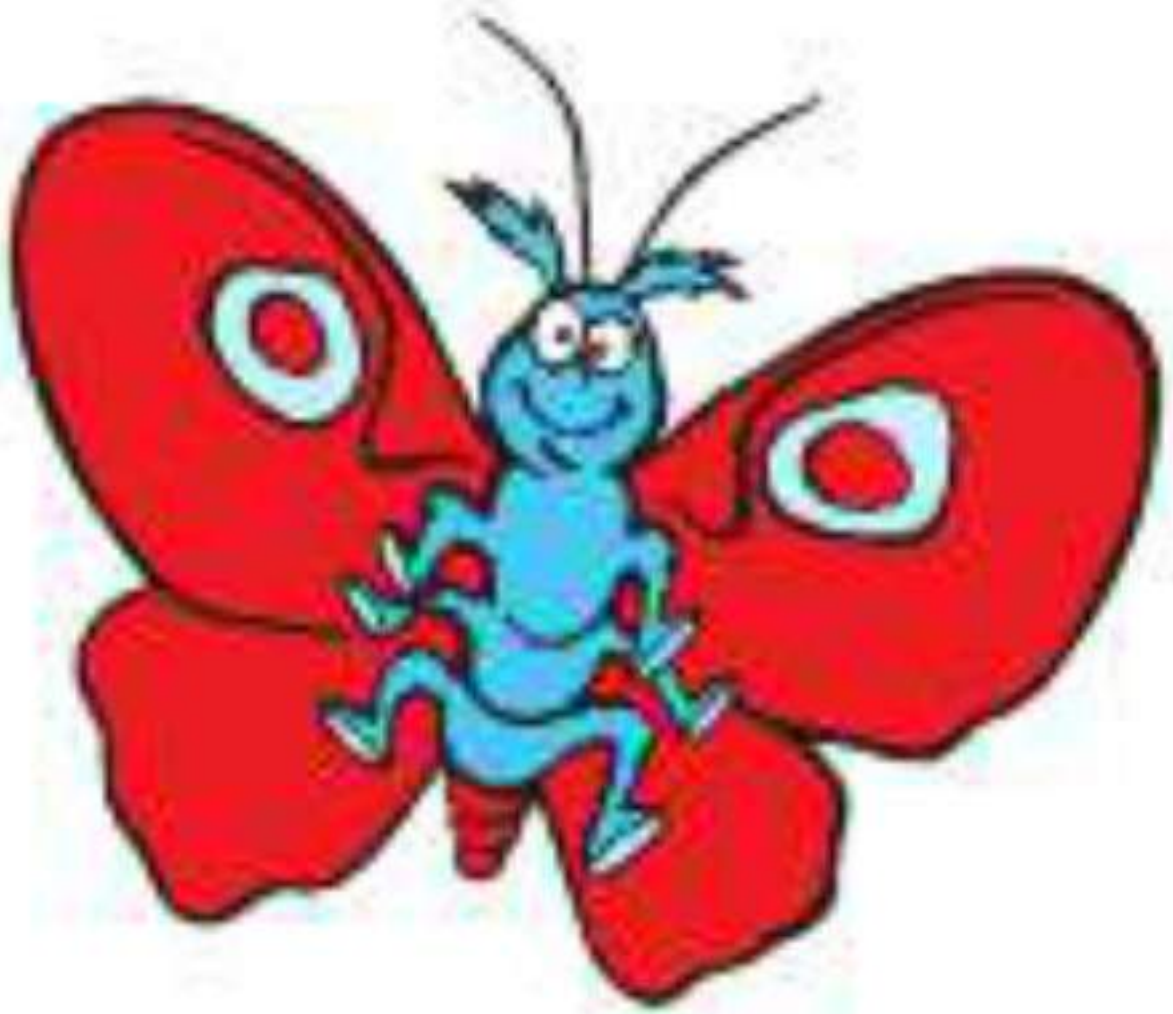
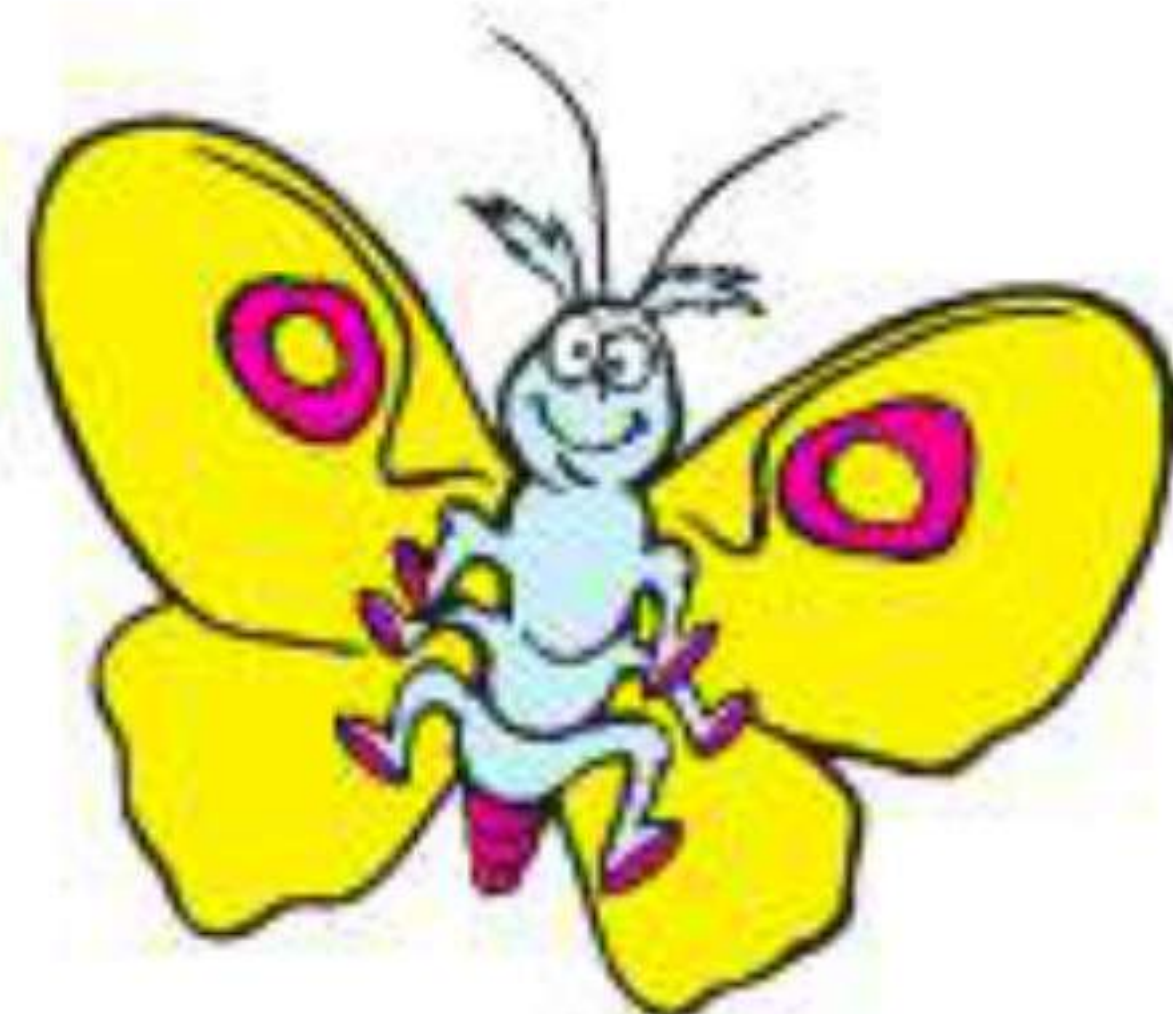
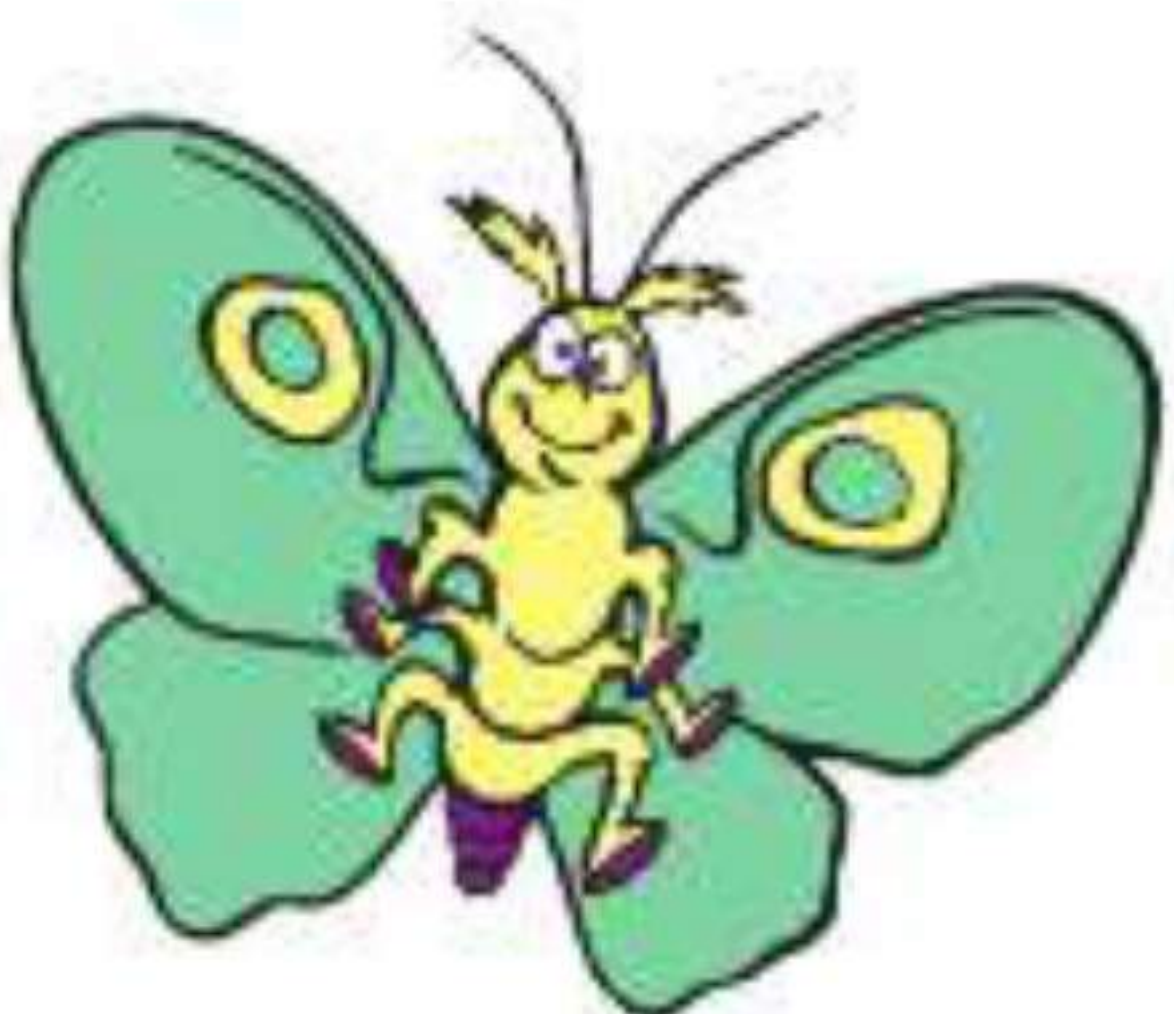
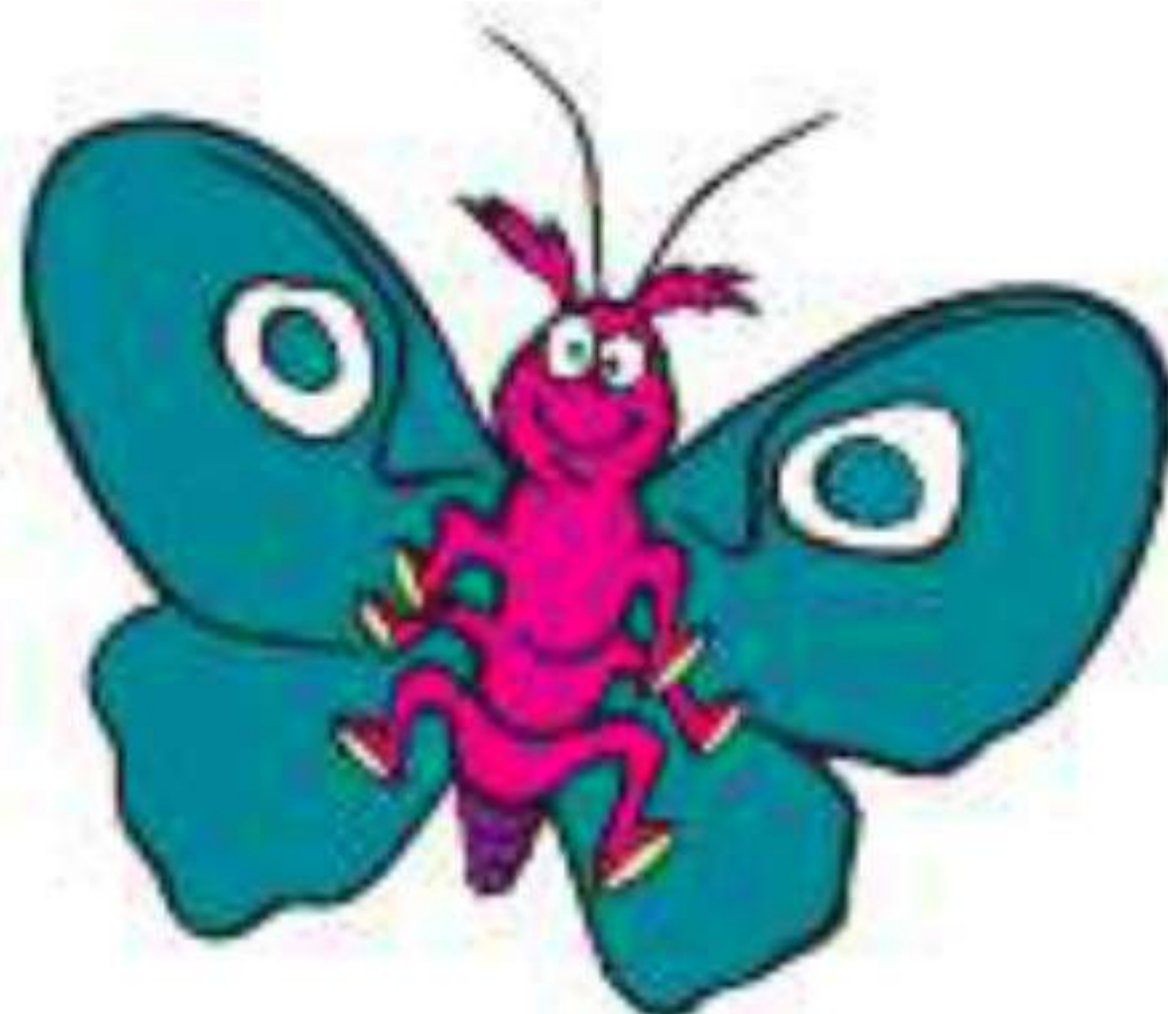
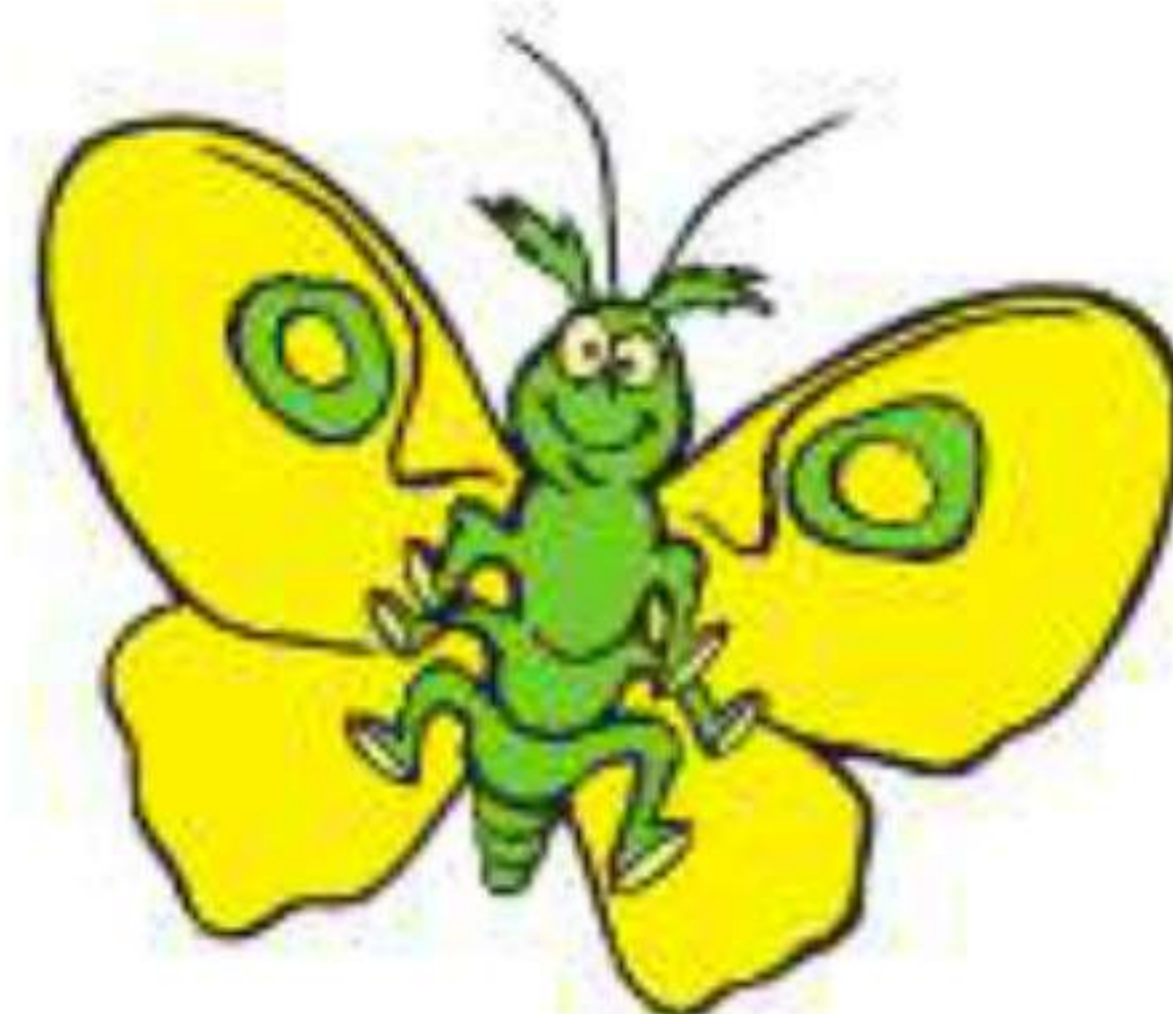
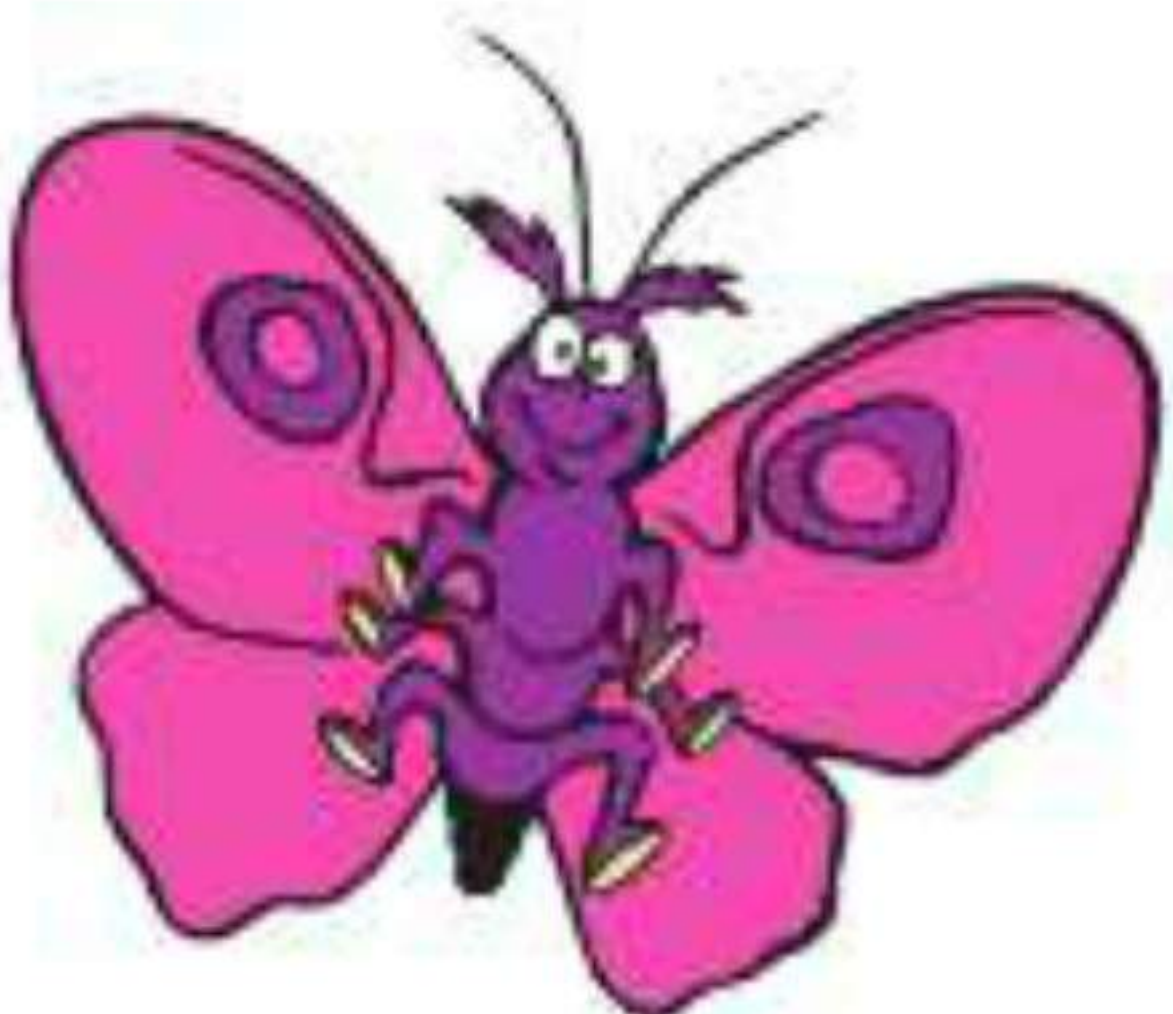
				
				
	8	9	10	



Review Numbers 7-10

Directions: Count each group of balloons. Trace each number. Then, count each group of balloons below. Write the number.

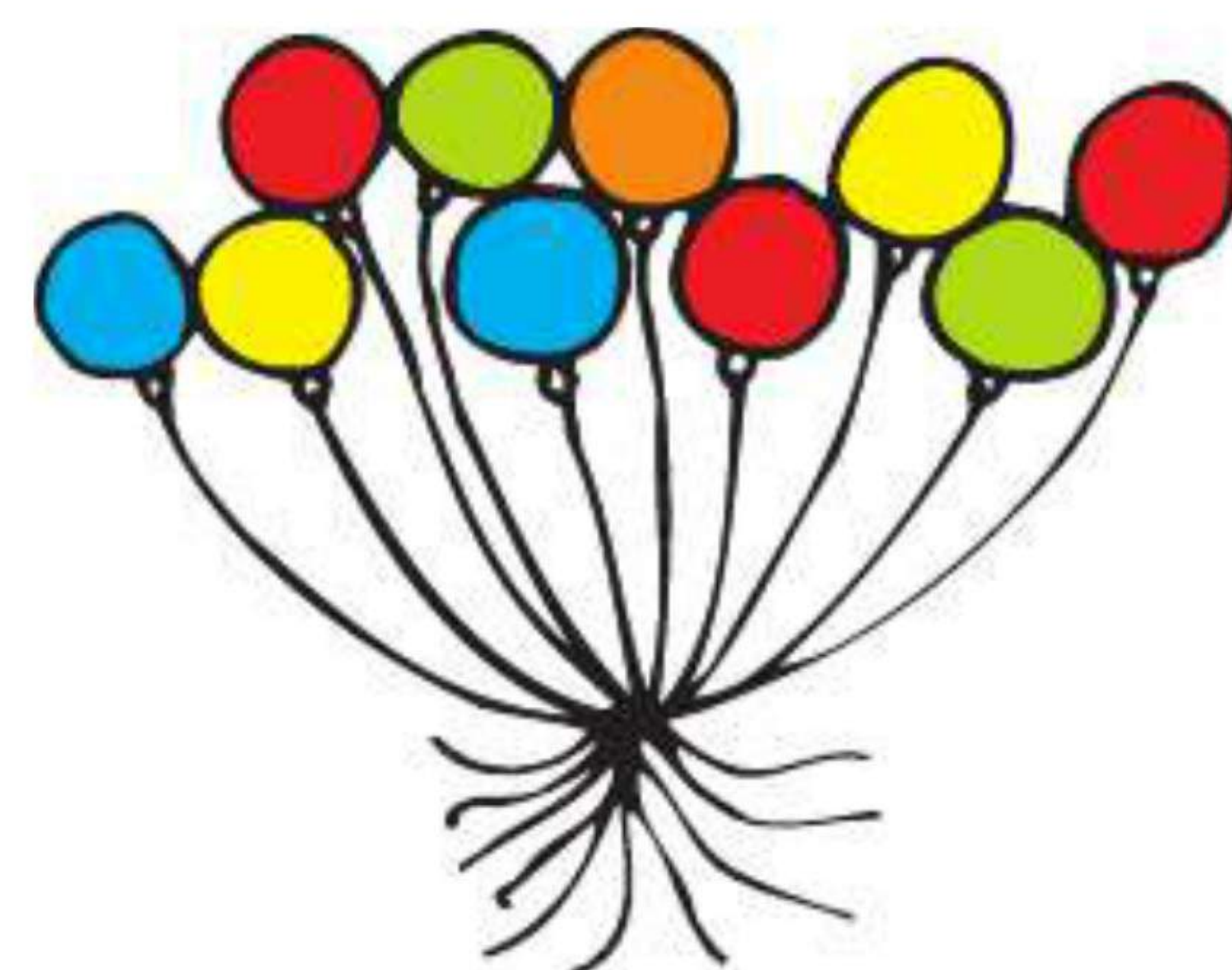
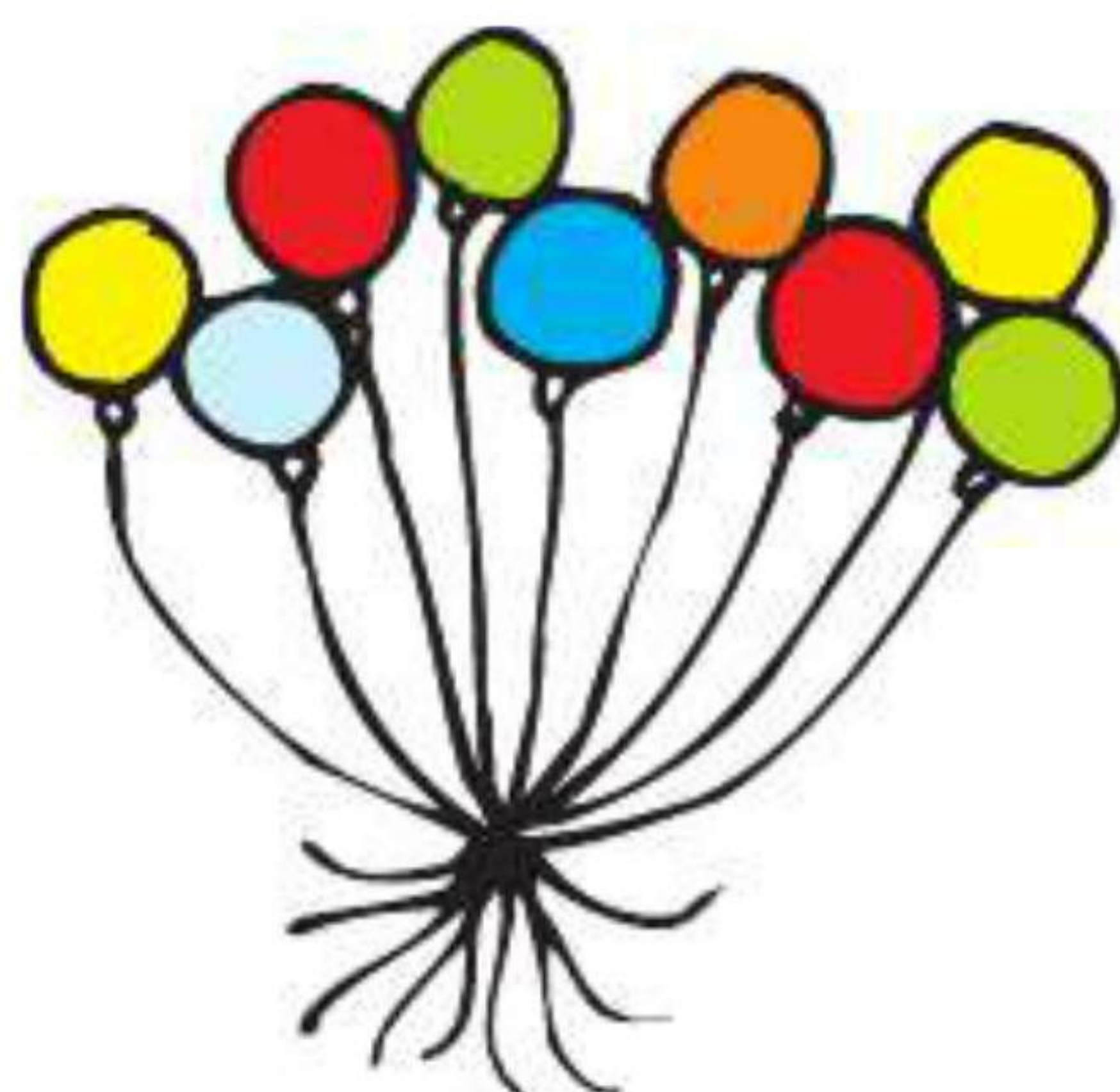
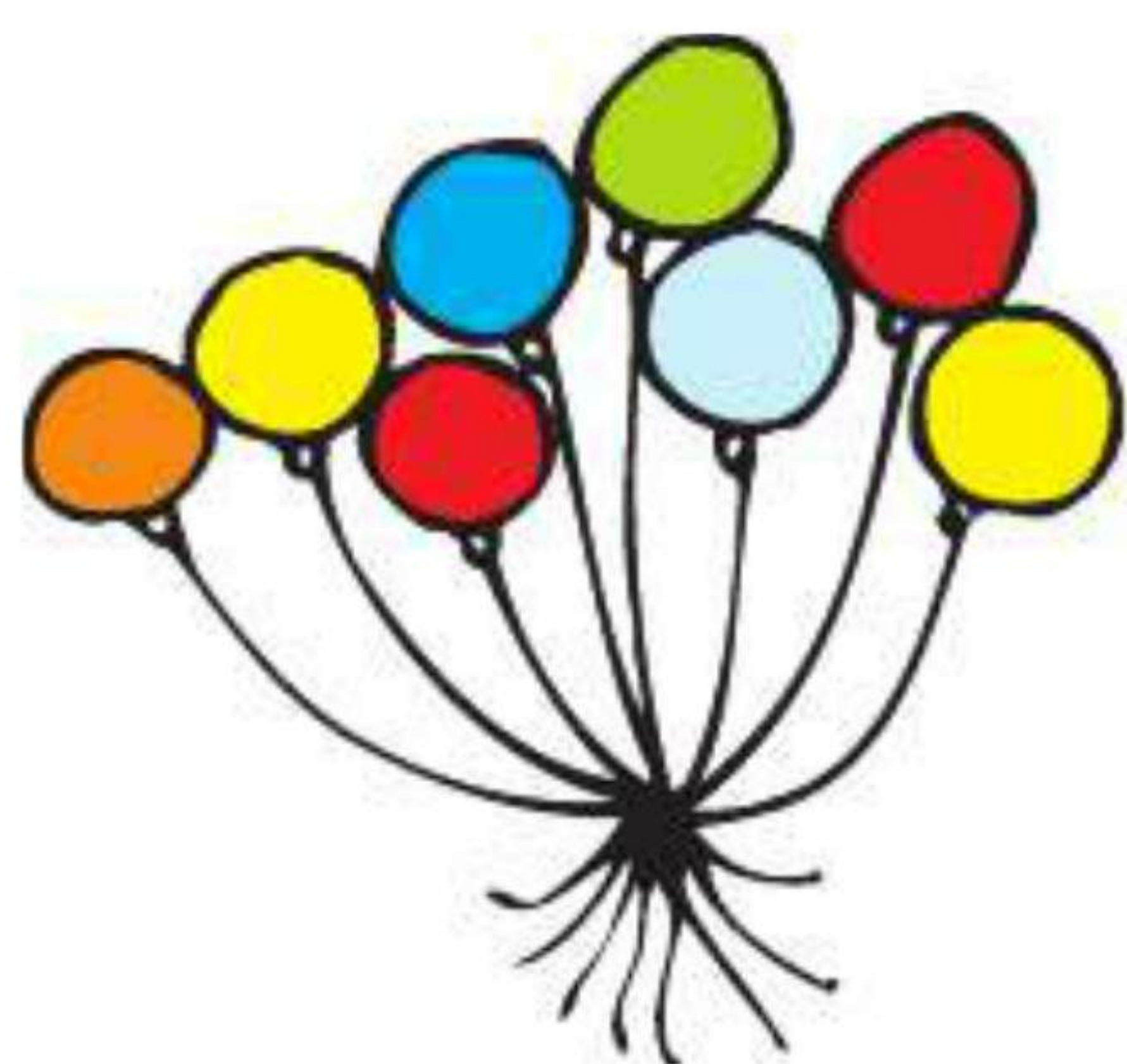
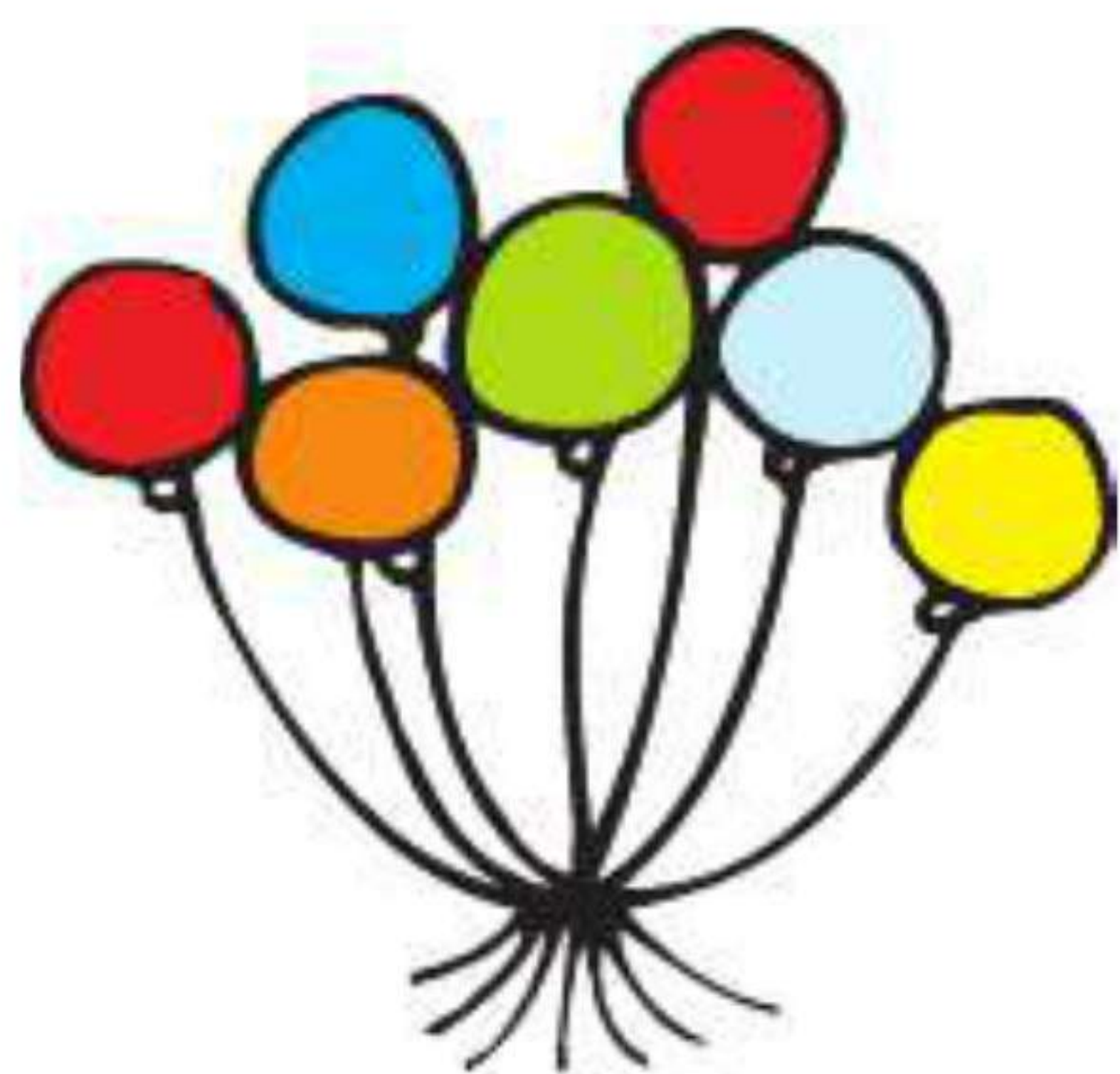
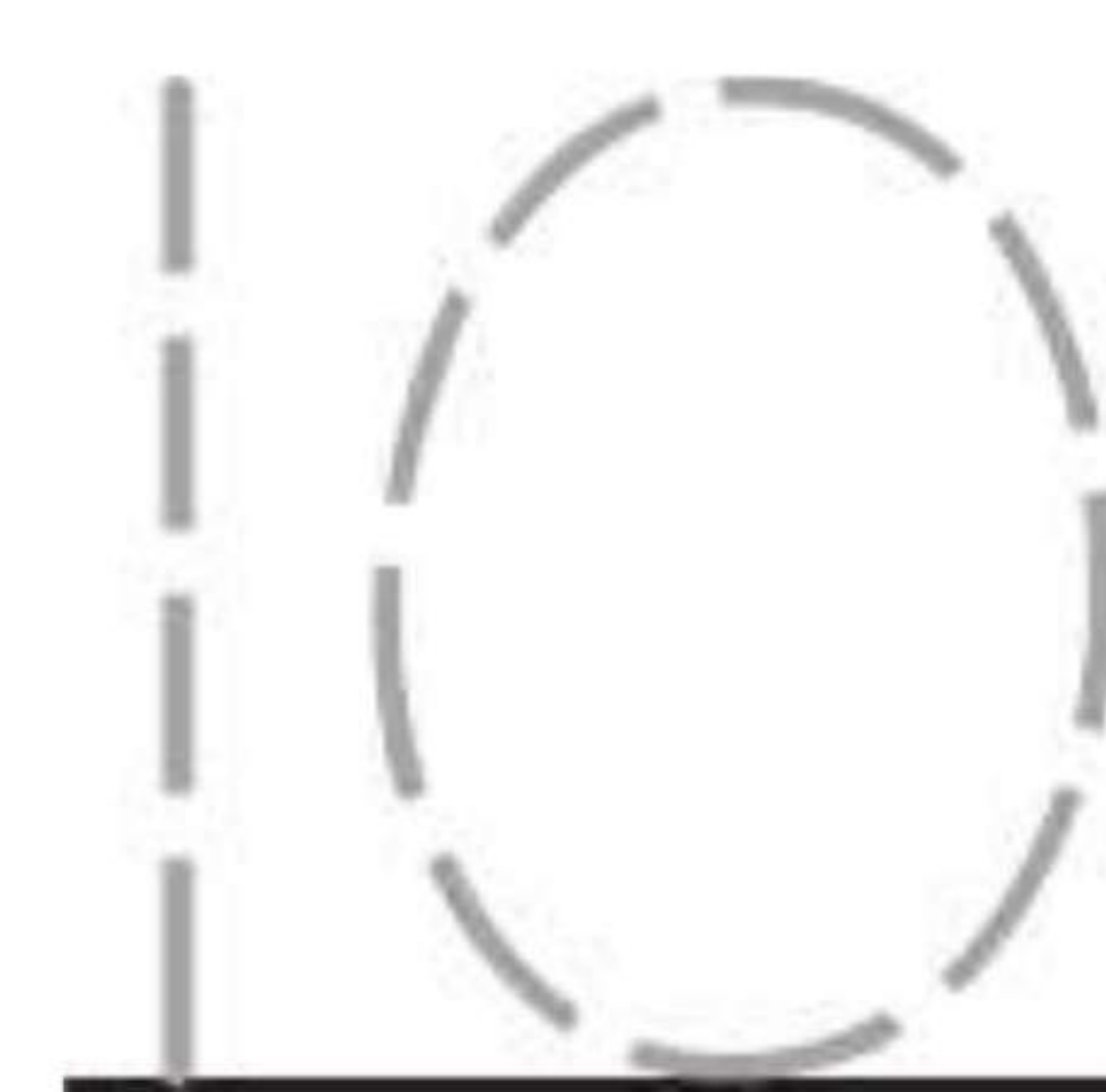
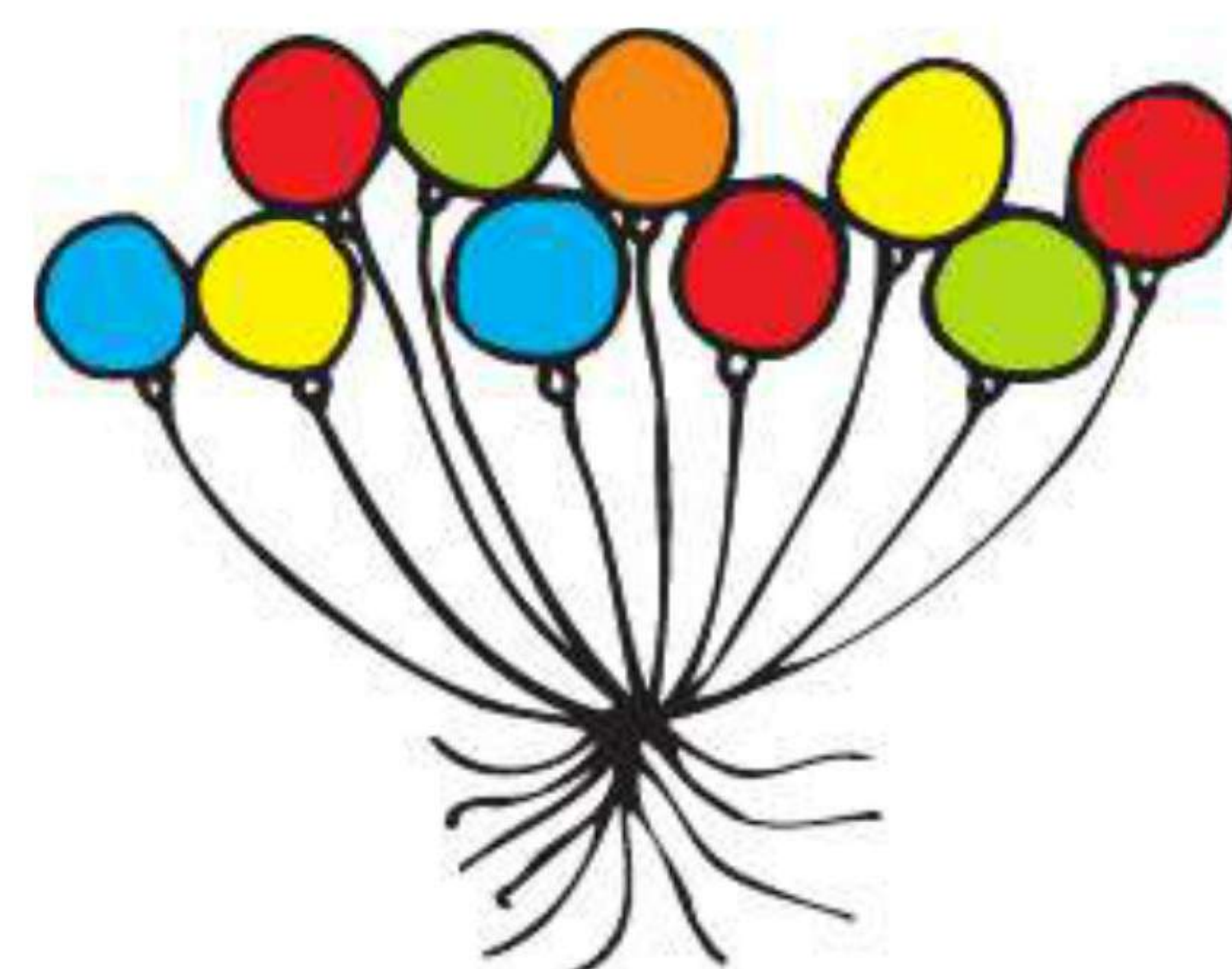
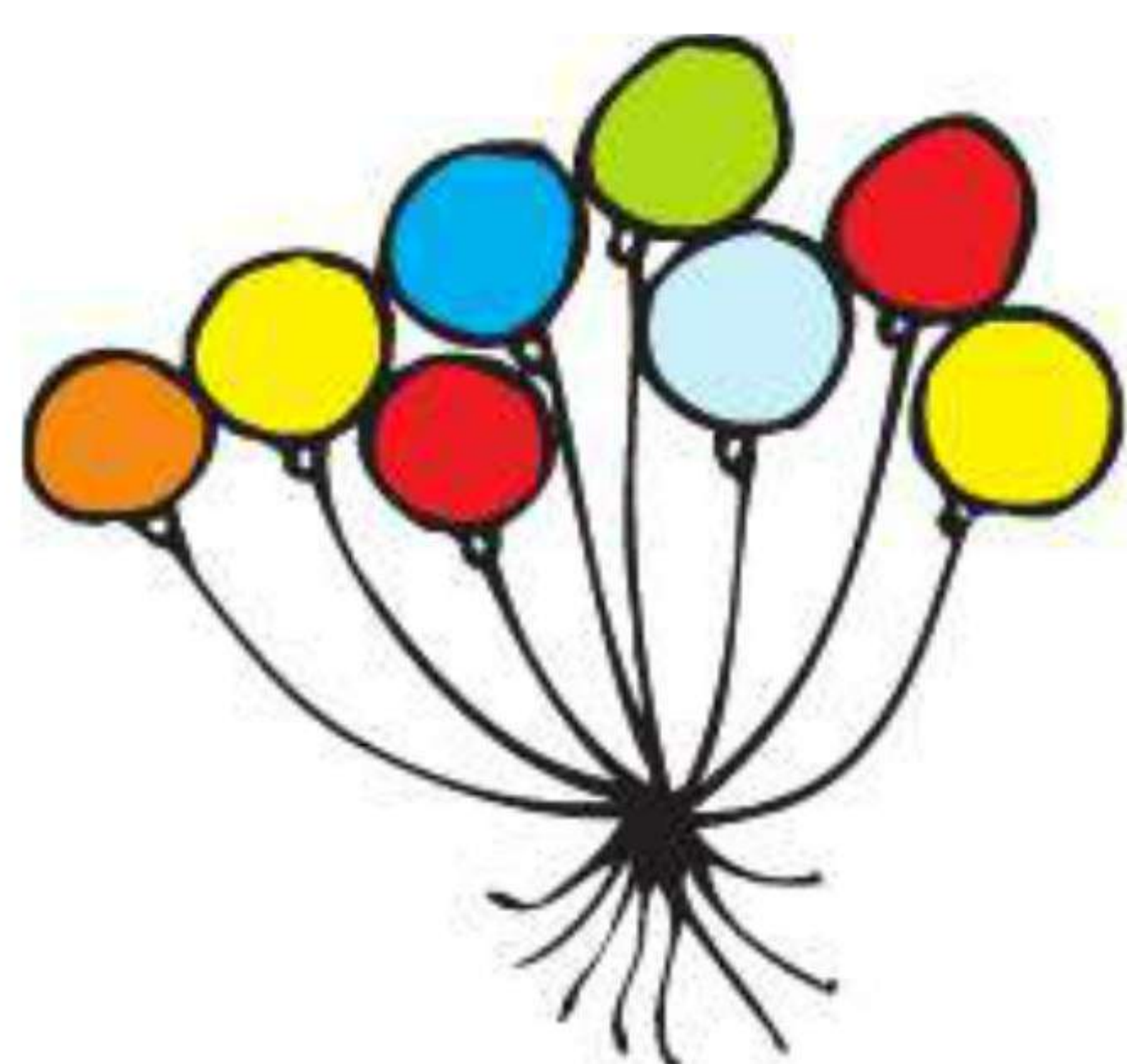
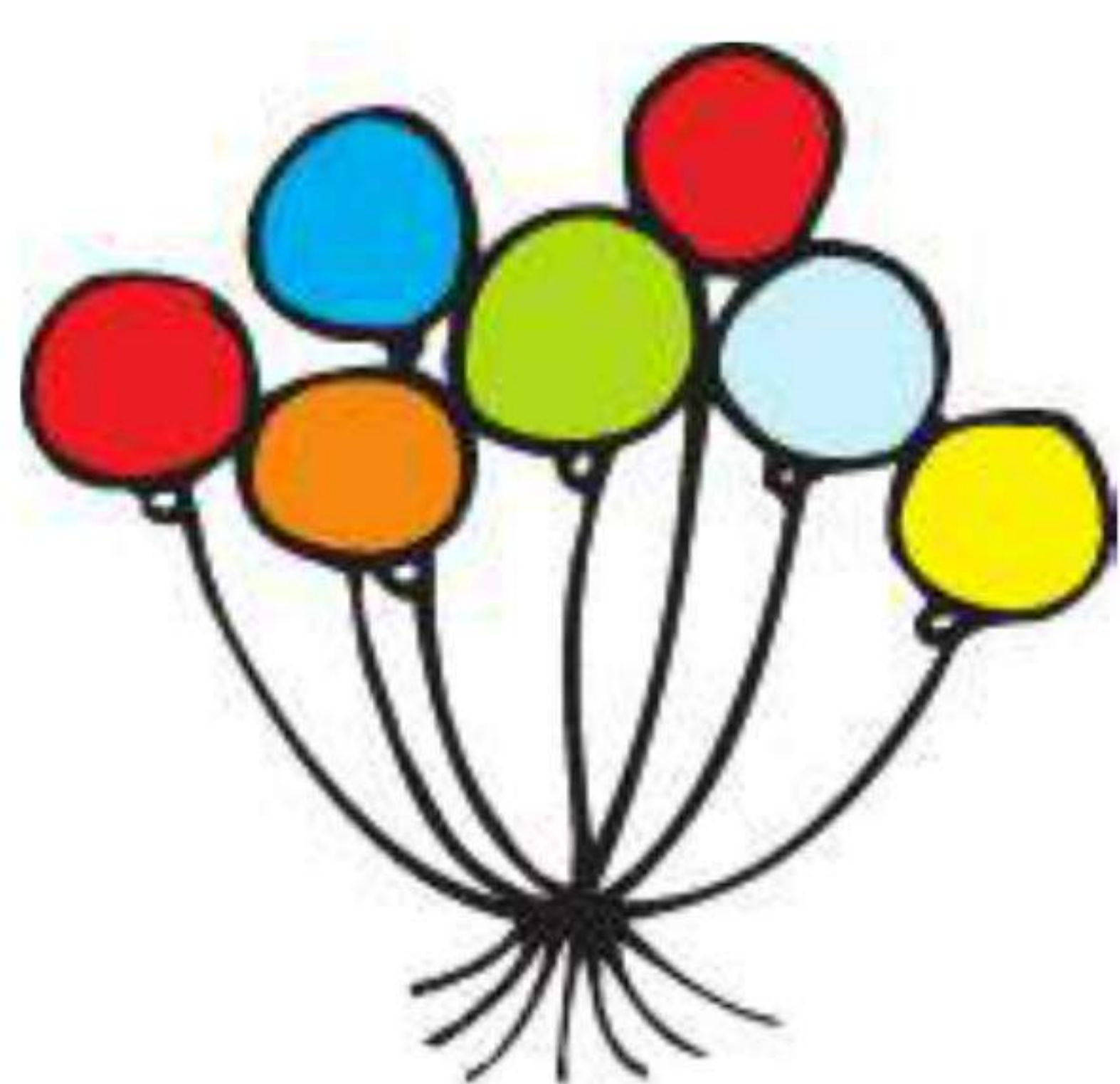



Review Numbers 1-10

Directions: Connect the dots from 1 to 10. Then, color the picture.

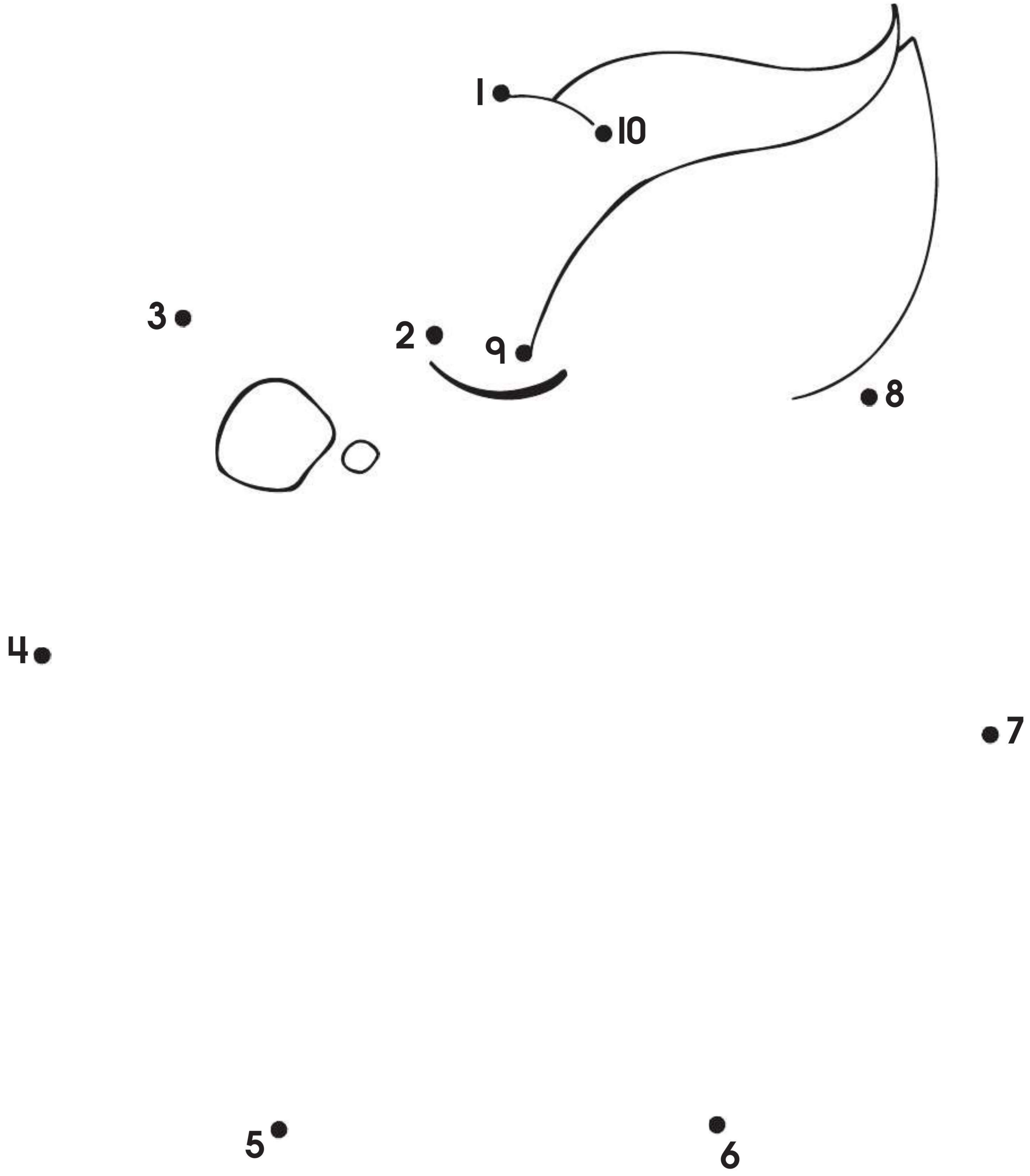



Eleven and Twelve 11, 12

Directions: Trace and write the numbers 11 and 12. Then, count and write the correct number.

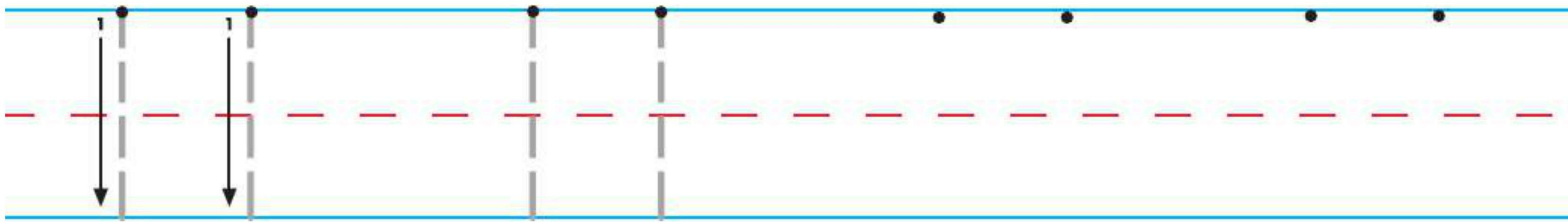

<p>_____</p>	<p>_____</p>
--------------	--------------

Name _____

NUMBERS 0-20



Eleven 11

Directions: Count Zeb Zebra's stripes and color them.

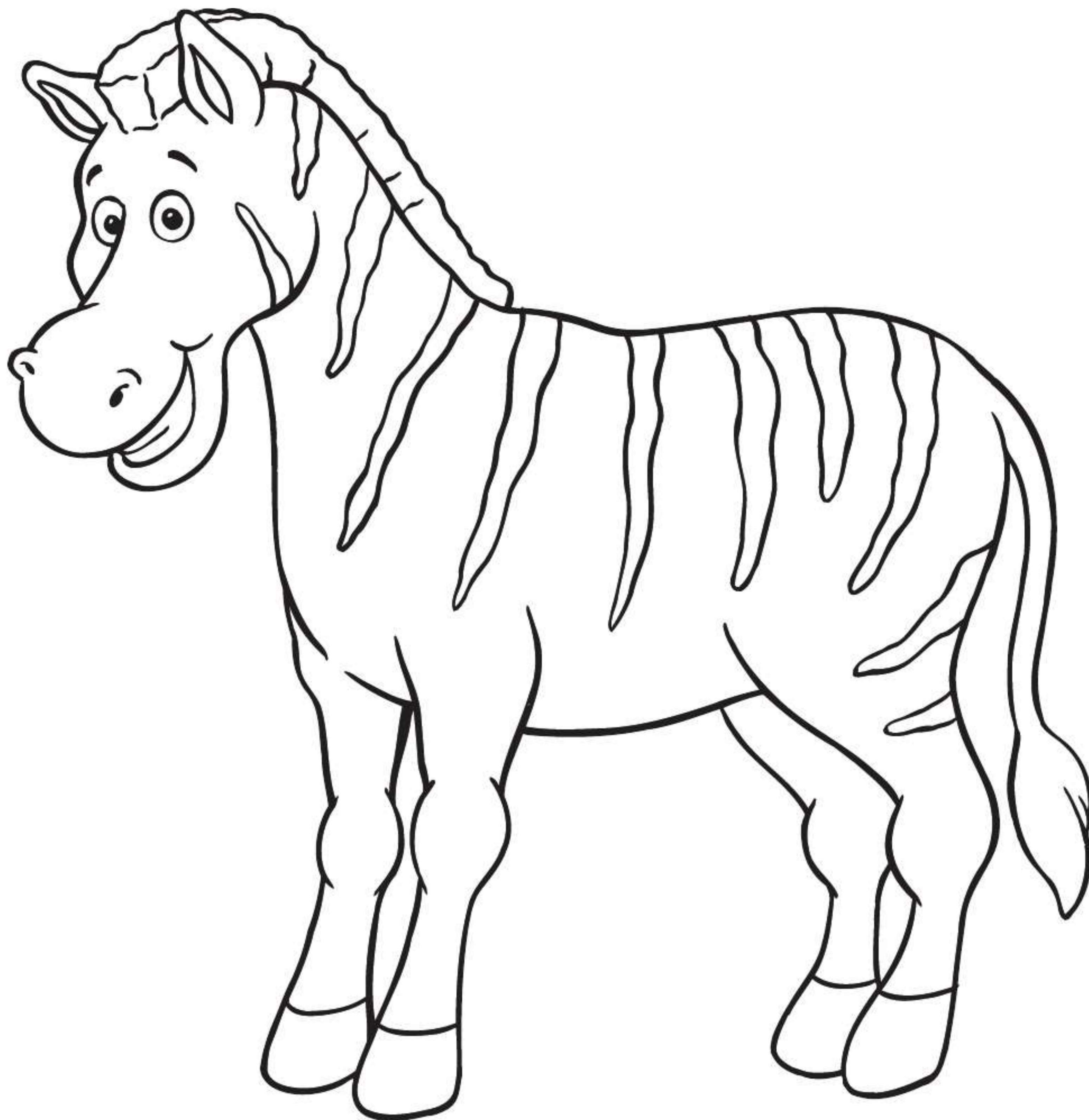



Twelve 12

Directions: Count each group of creatures. Draw a line from the animals to their matching apples.

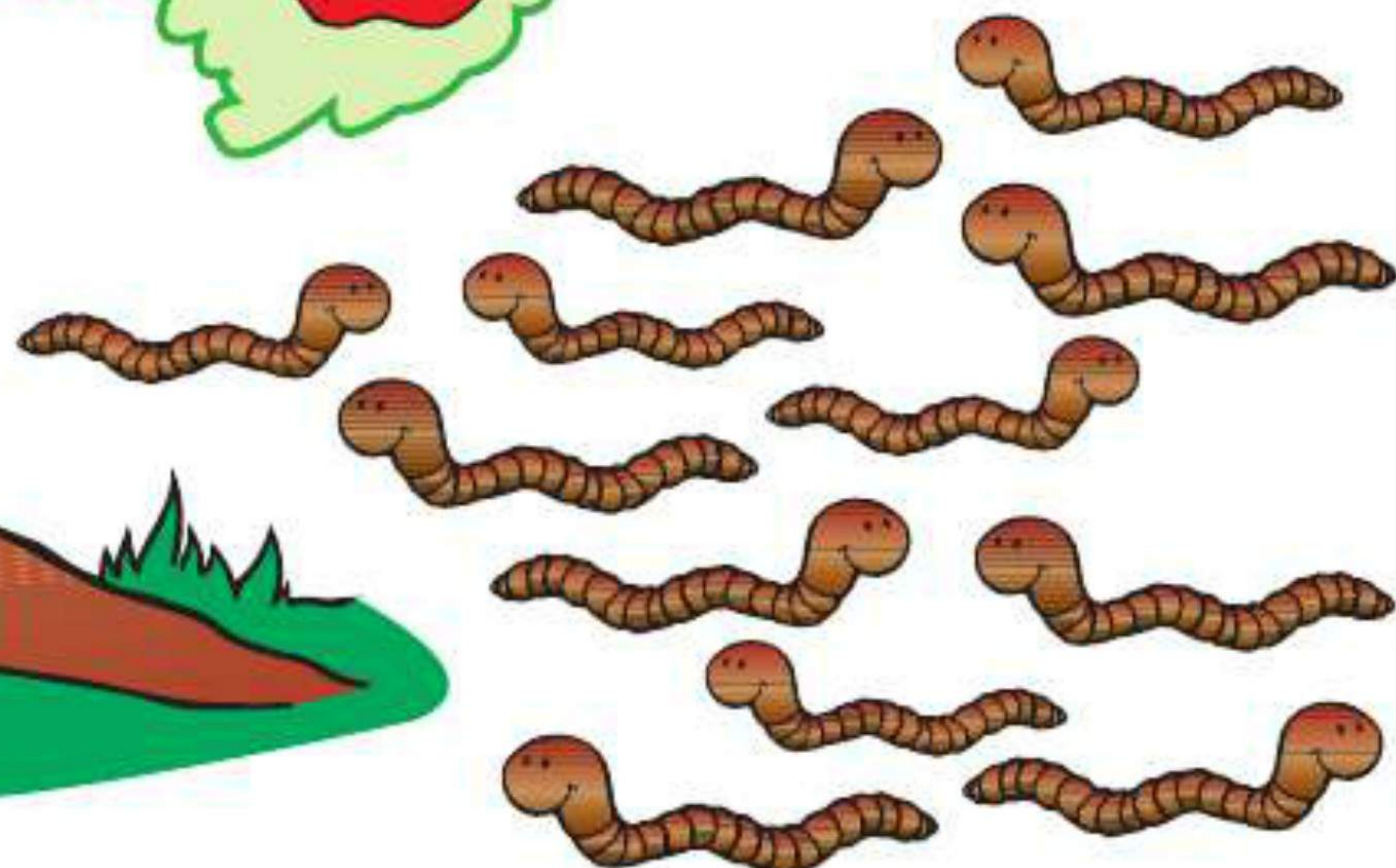
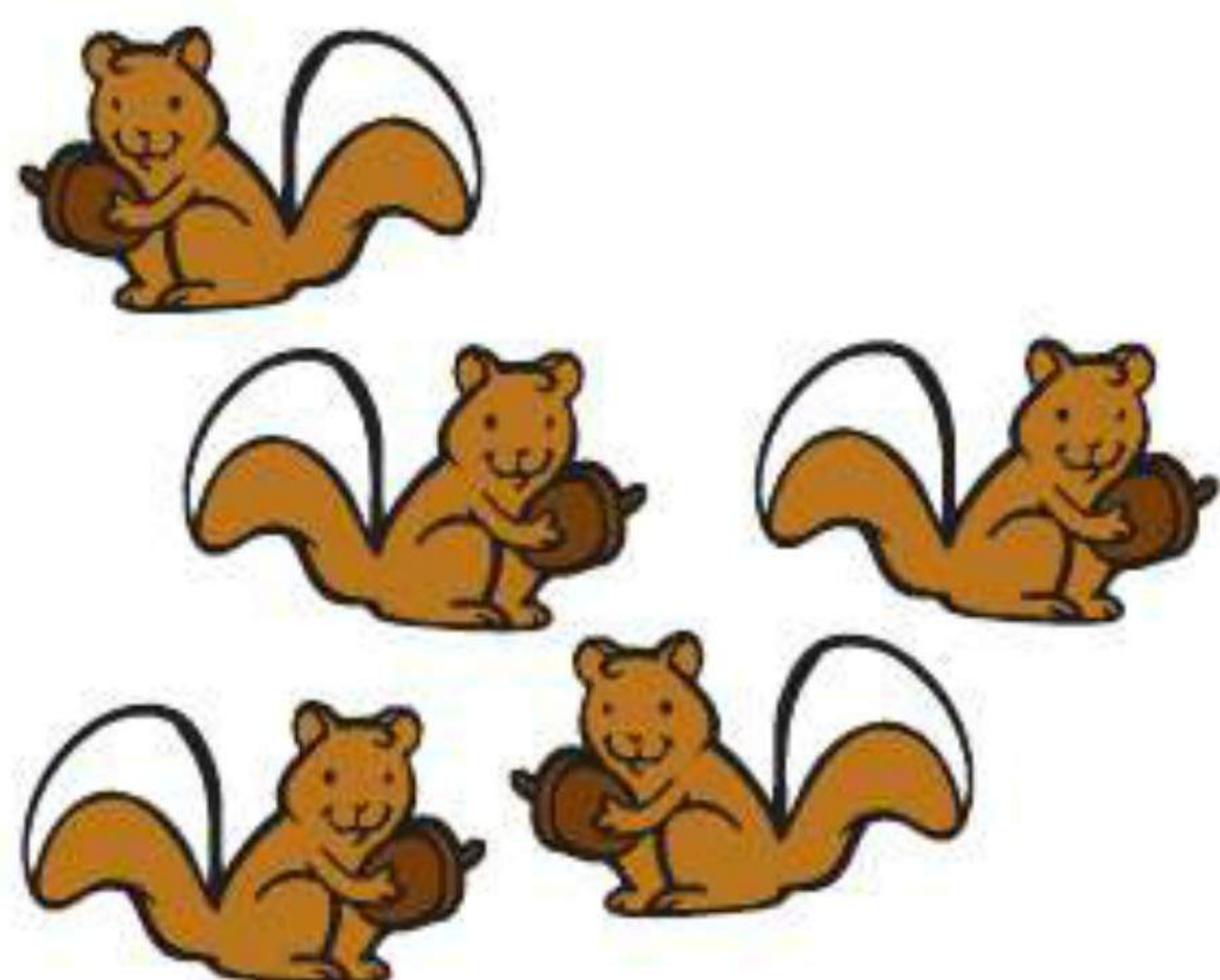
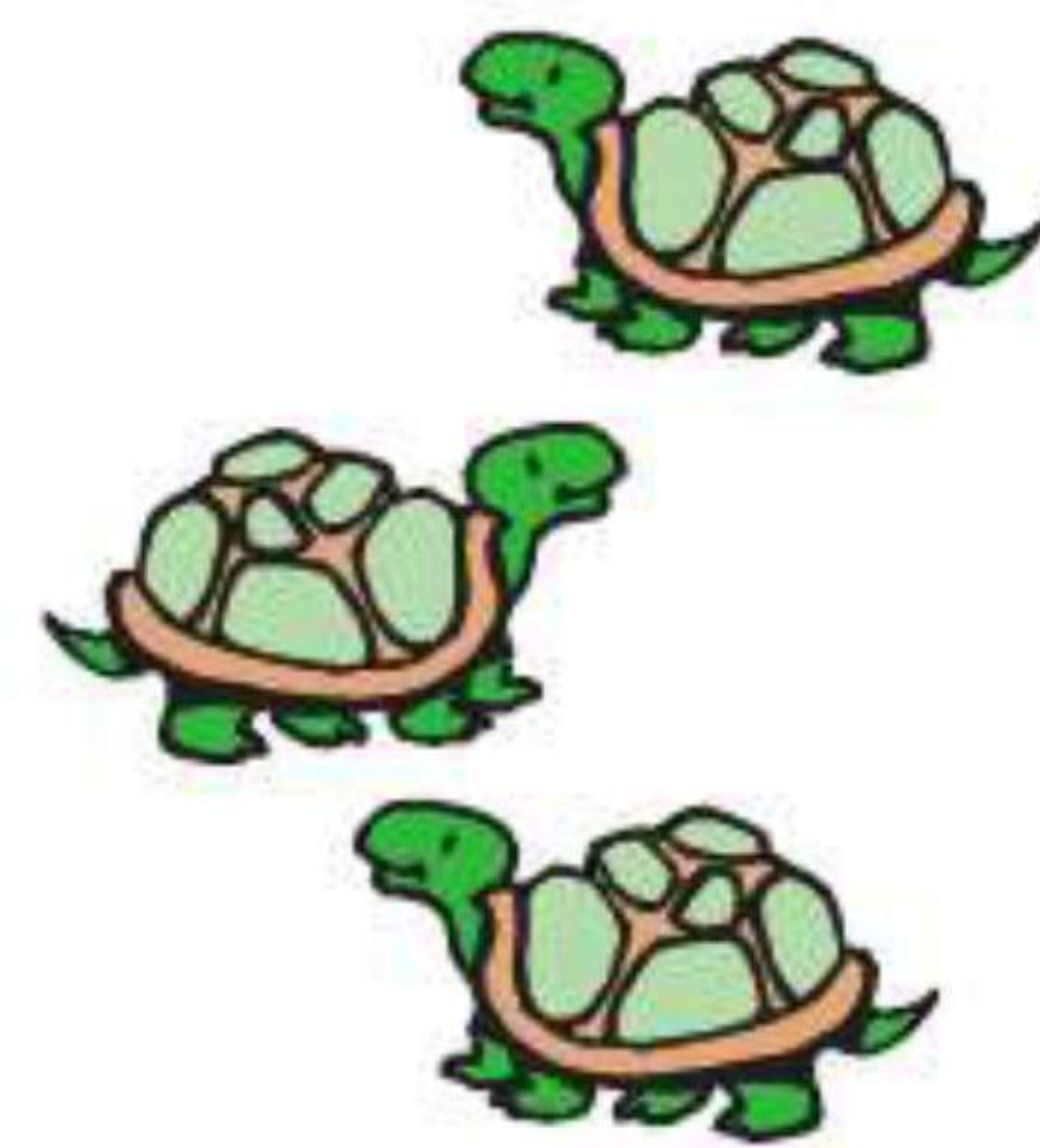
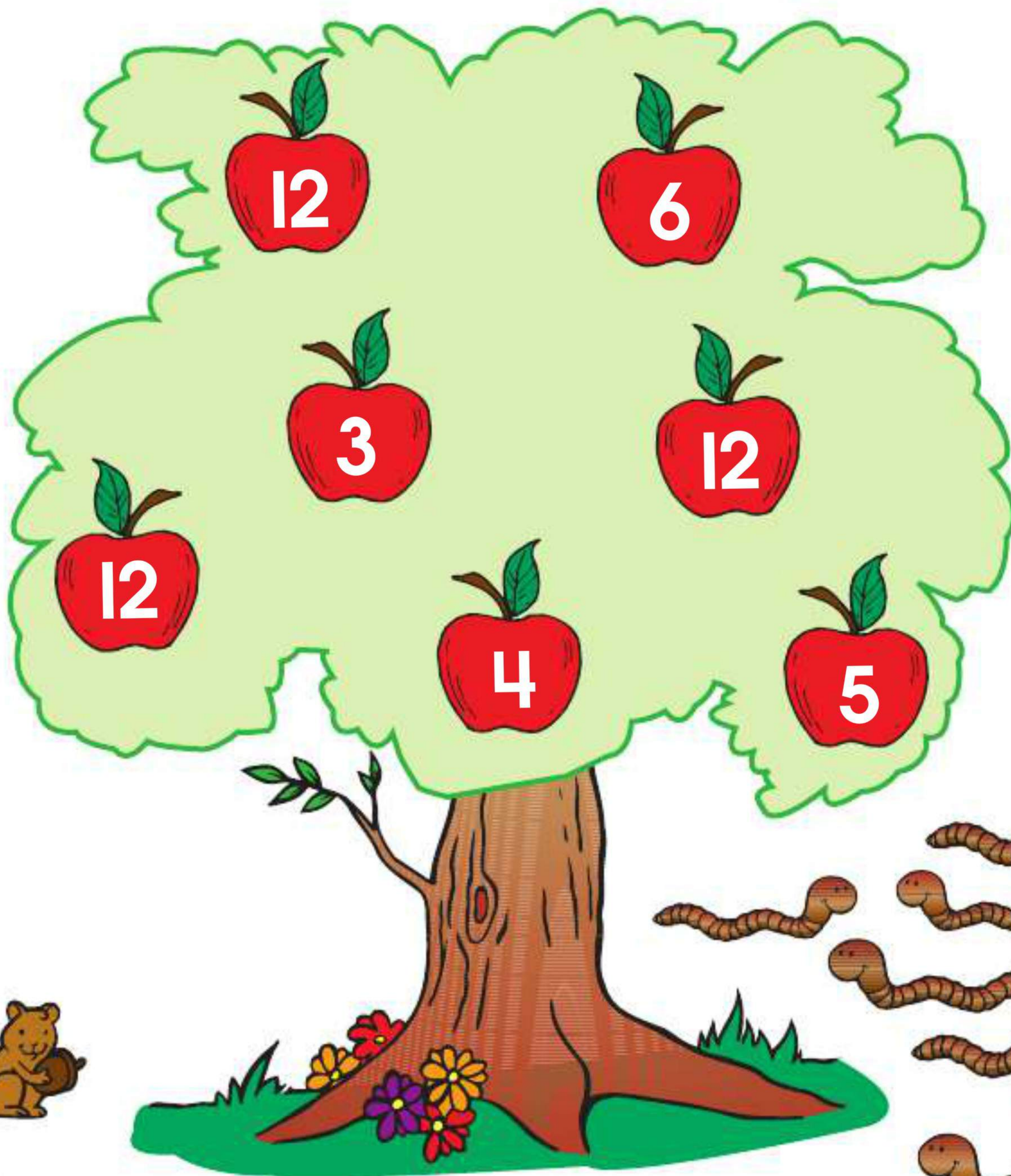
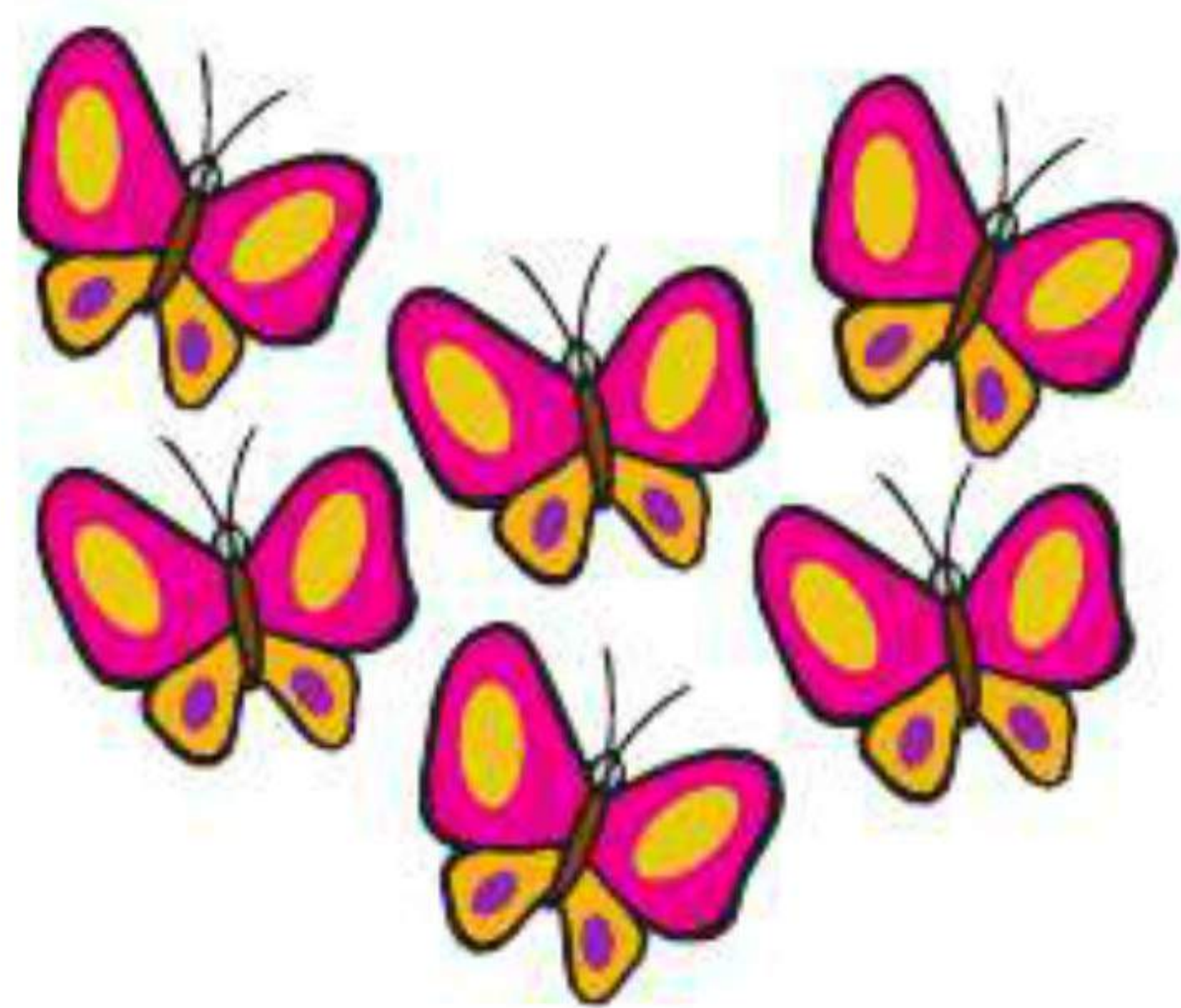
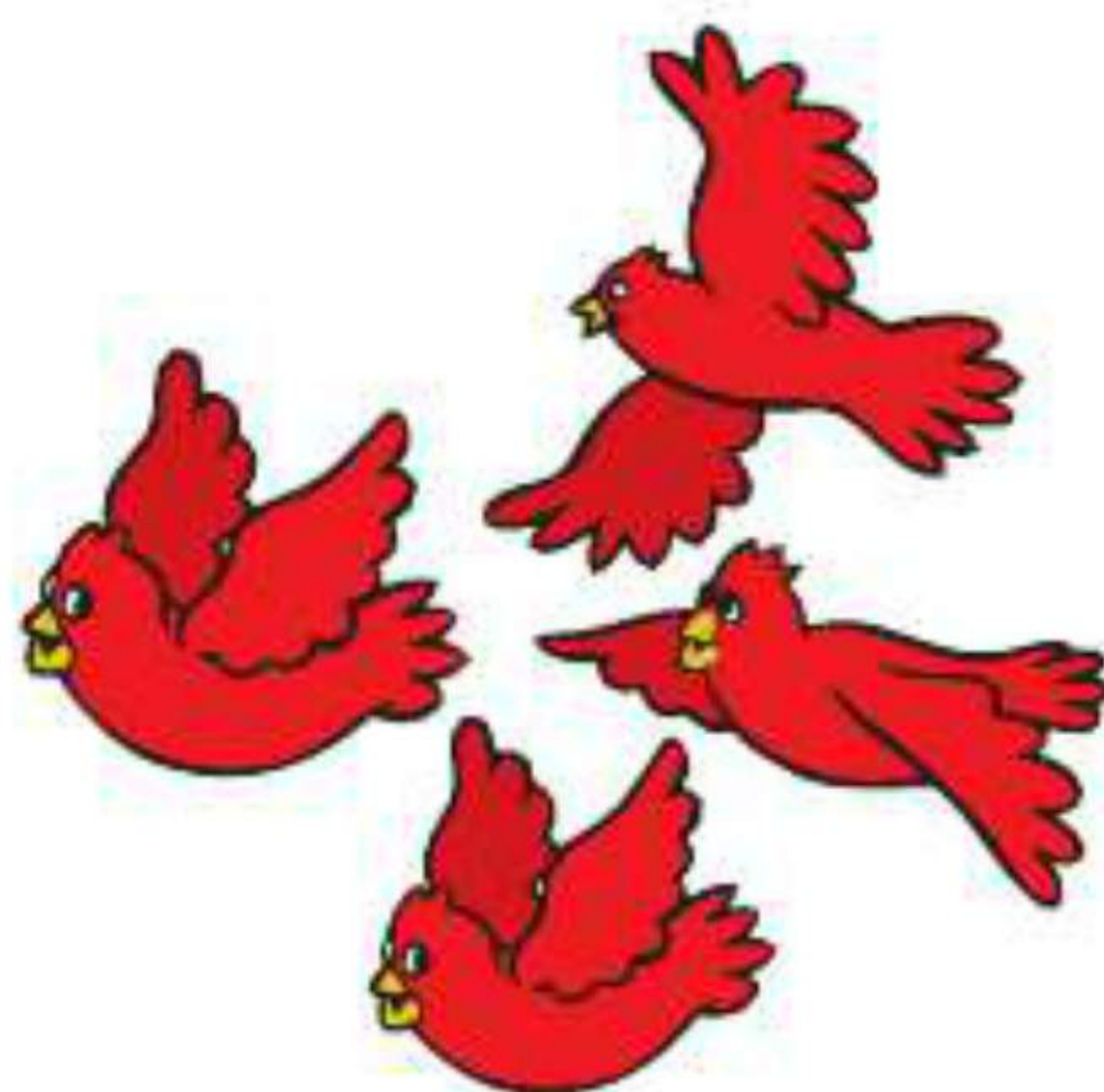
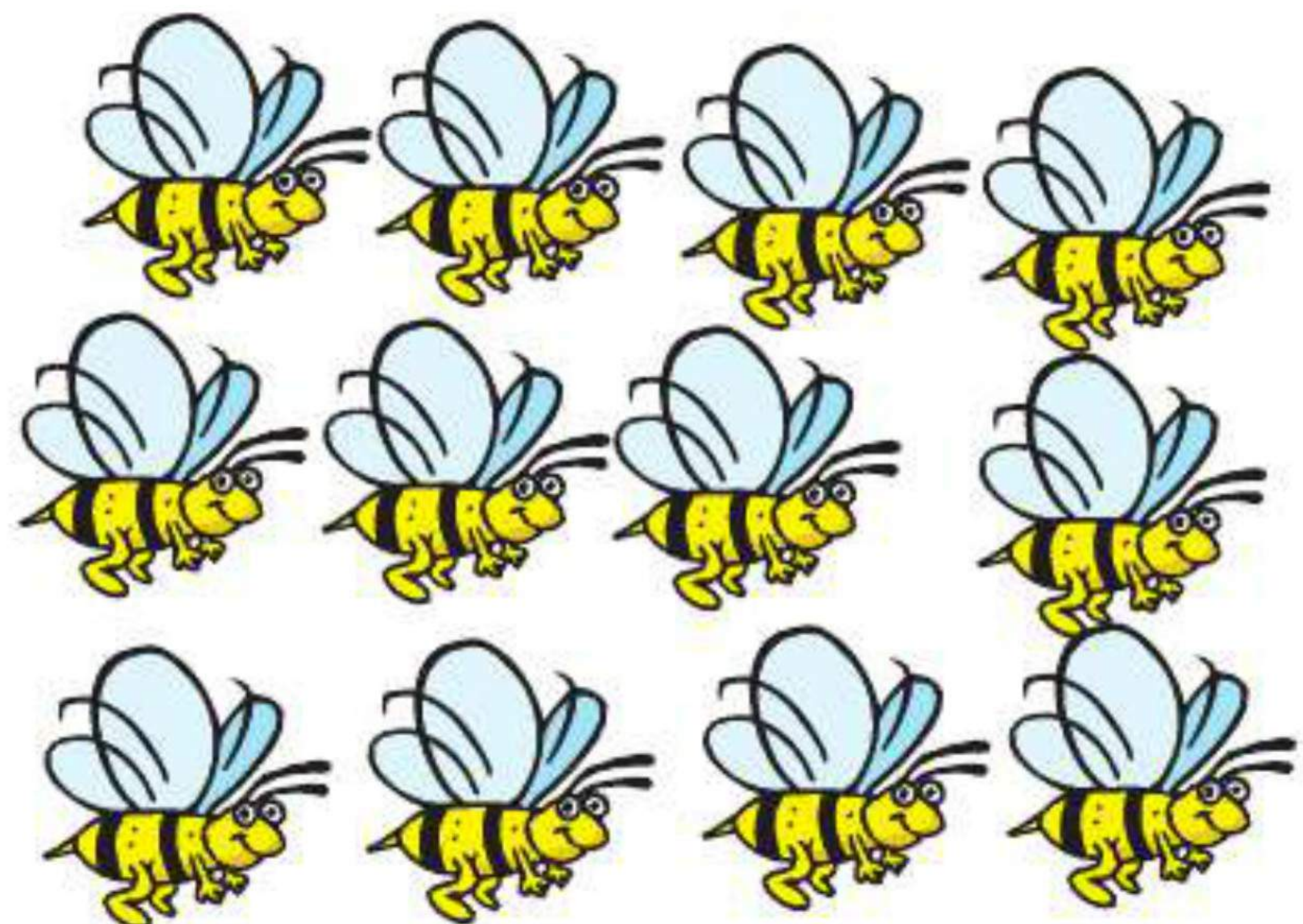

Name _____



Thirteen 13

Directions: Trace and write the number **13**. Complete each picture by drawing the missing number of flowers.

Tracing practice for the number 13. The first row shows a solid '13' with stroke order arrows, followed by a dashed '13' for tracing, and then a blank line with a starting dot for the '1' and a starting dot for the '3'. Below this are two more blank lines with a starting dot for the '1' and a starting dot for the '3' for independent writing practice.

A rounded rectangular box containing the number '13' in purple. Below the number are 10 colorful flowers (yellow and red petals with green leaves) arranged in a pattern: one in the top left, one in the top right, one in the middle left, one in the middle right, and six in a row at the bottom.

A rounded rectangular box containing the number '13' in purple. The box is otherwise empty, intended for the student to draw 13 flowers to complete the picture.



Fourteen 14

Directions: Trace and write the number 14. Connect the dots. Color the picture.

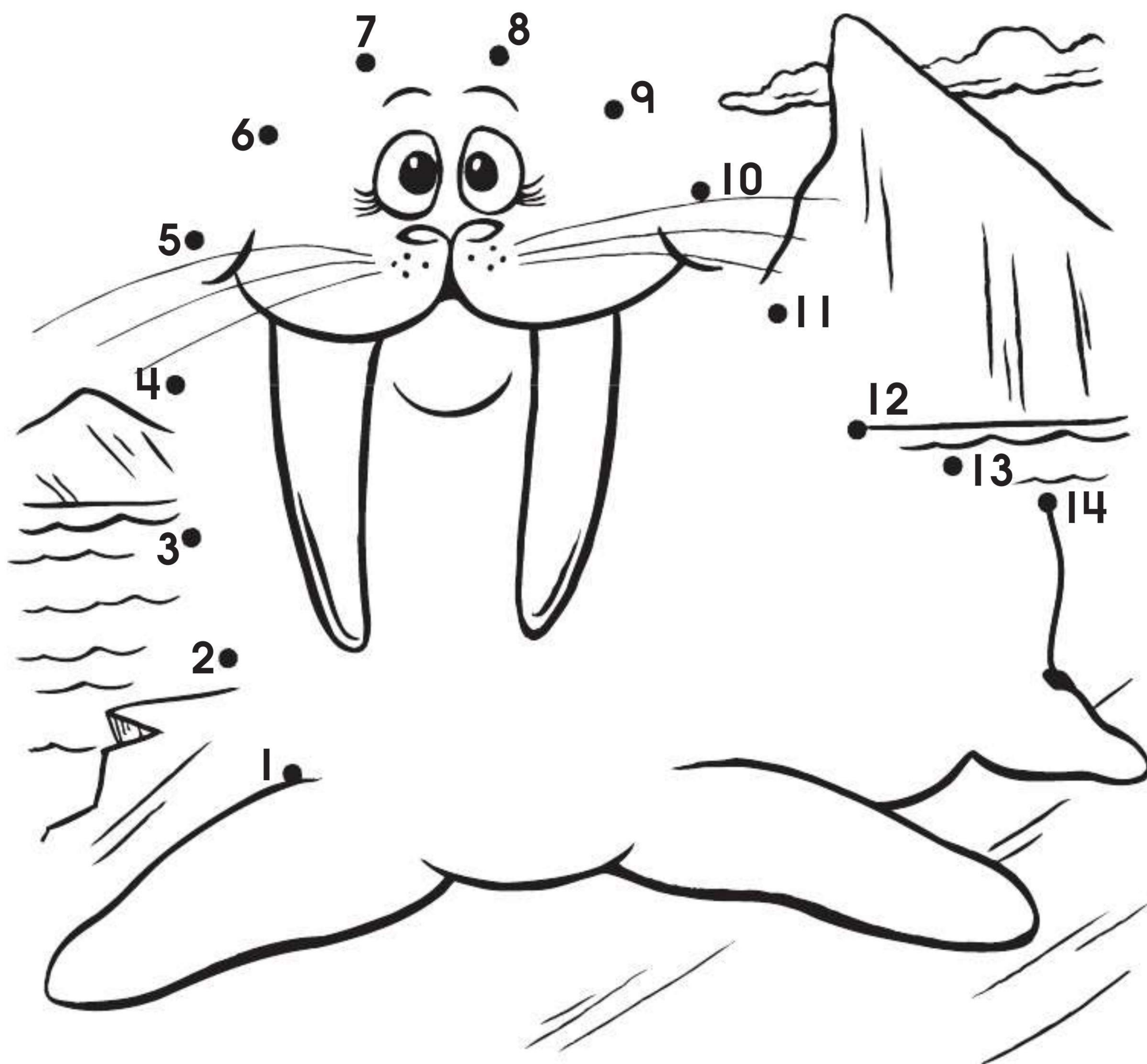
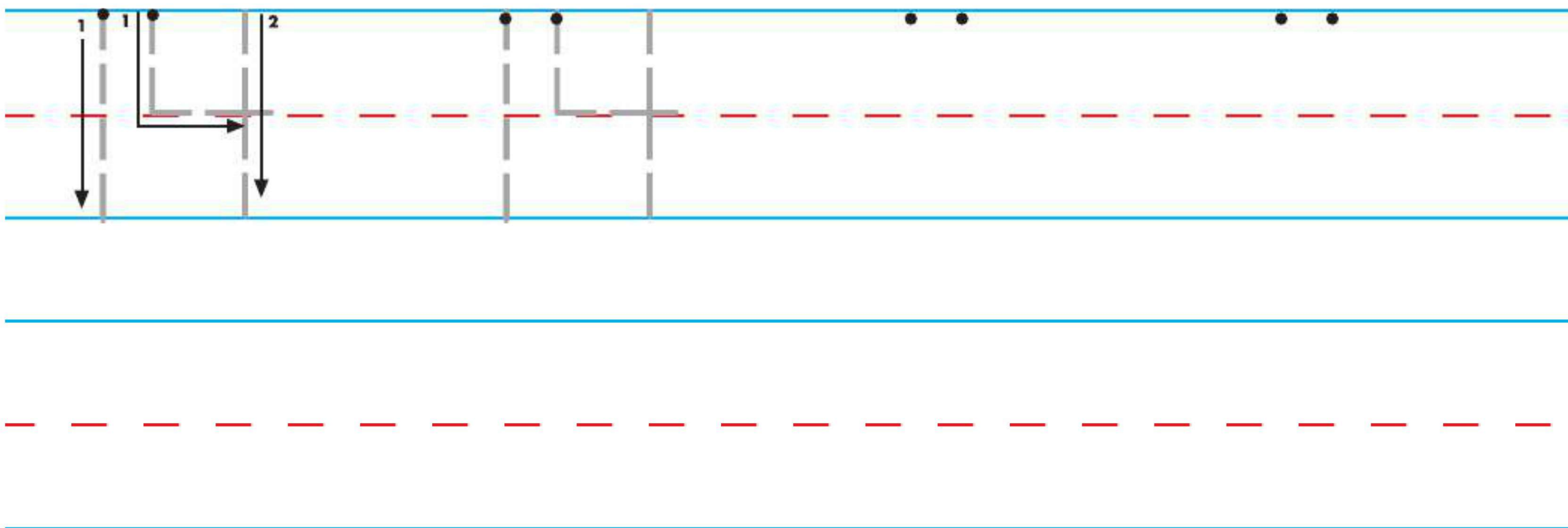



Fifteen 15

Directions: Trace and write the number **15**. Then, write the missing pool ball numbers.

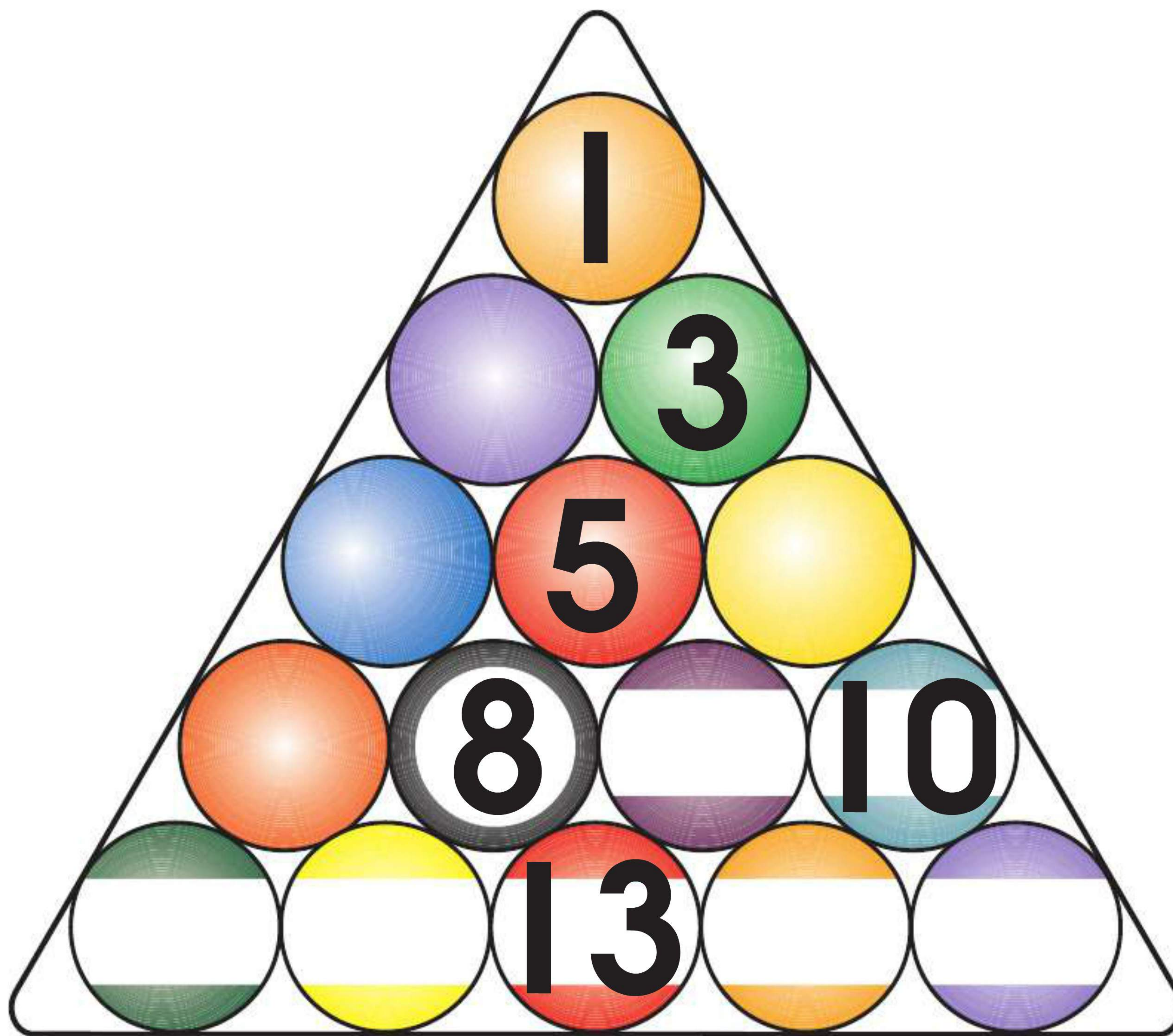



Sixteen 16

Directions: Trace and write the number 16. Then, draw eight legs on each spider.

Tracing practice area with three rows of handwriting lines (top blue, middle red dashed, bottom blue). The first row shows a vertical line '1' and a circular '6' with numbered arrows indicating stroke order. The second row shows dashed '1' and '6' for tracing. The third row shows eight dots on the top blue line, intended for drawing legs.

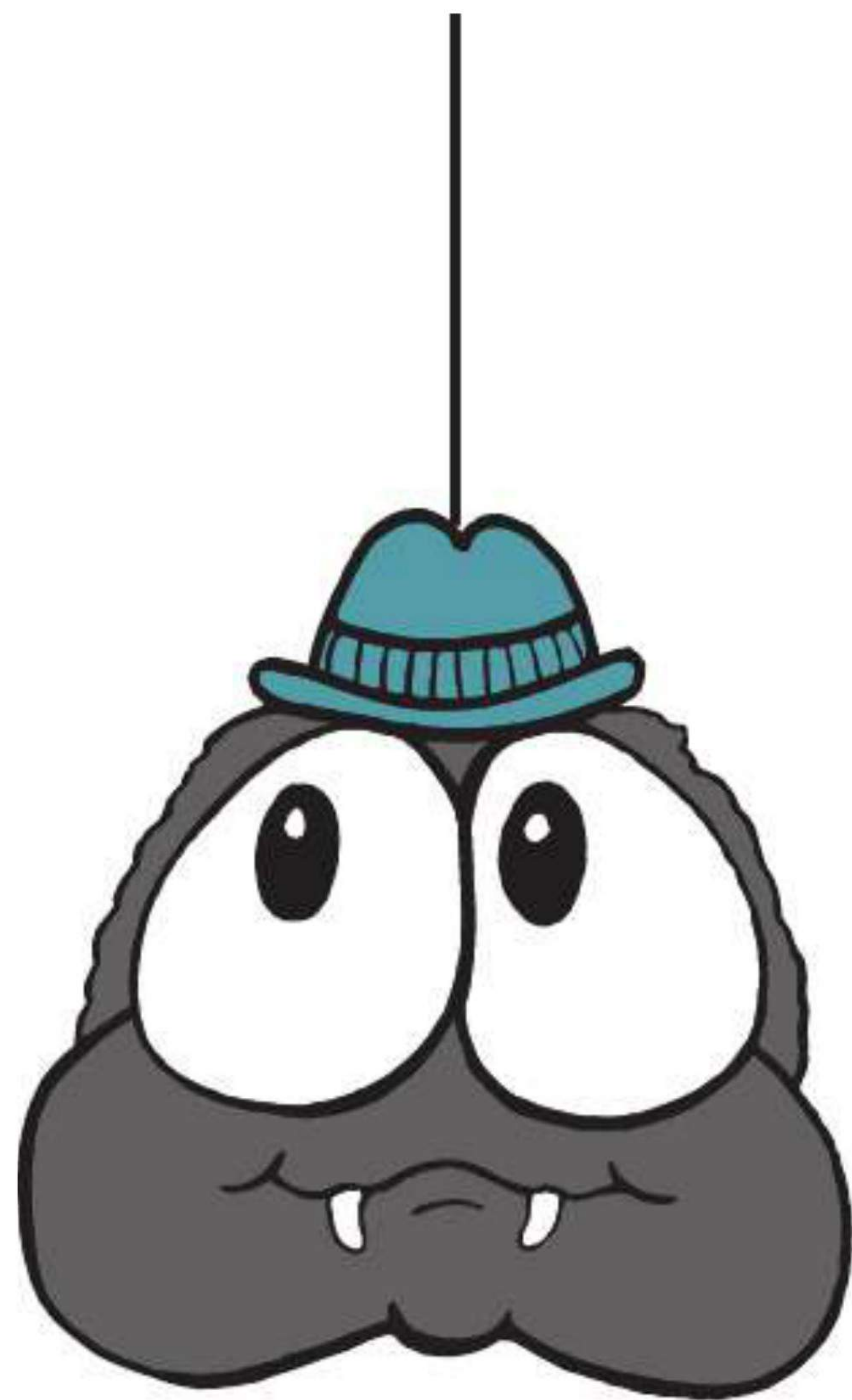
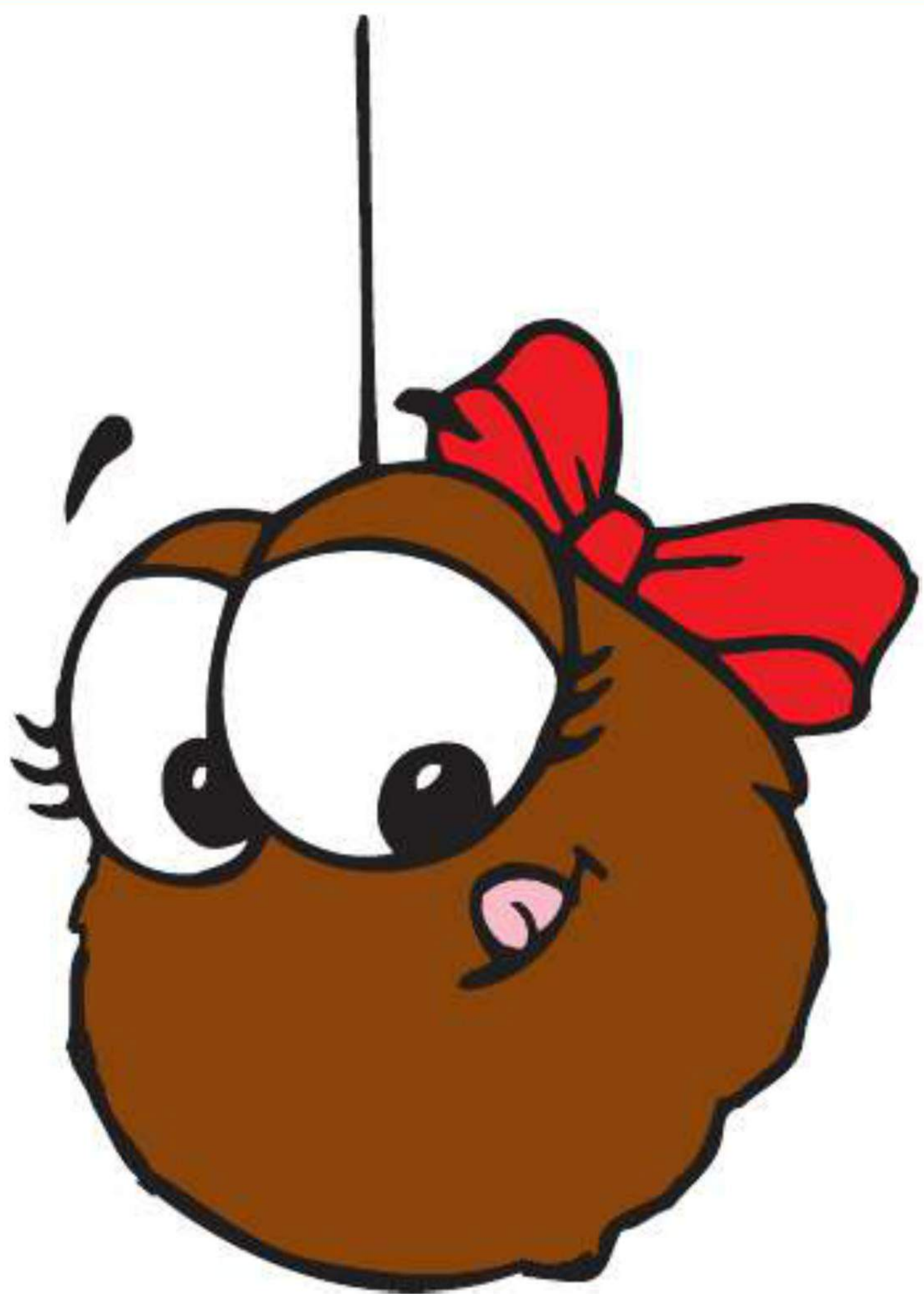

How many legs are there in all? _____



Seventeen 17

Directions: Trace and write the number **17**. Circle each group of **17** things. Color the dog.

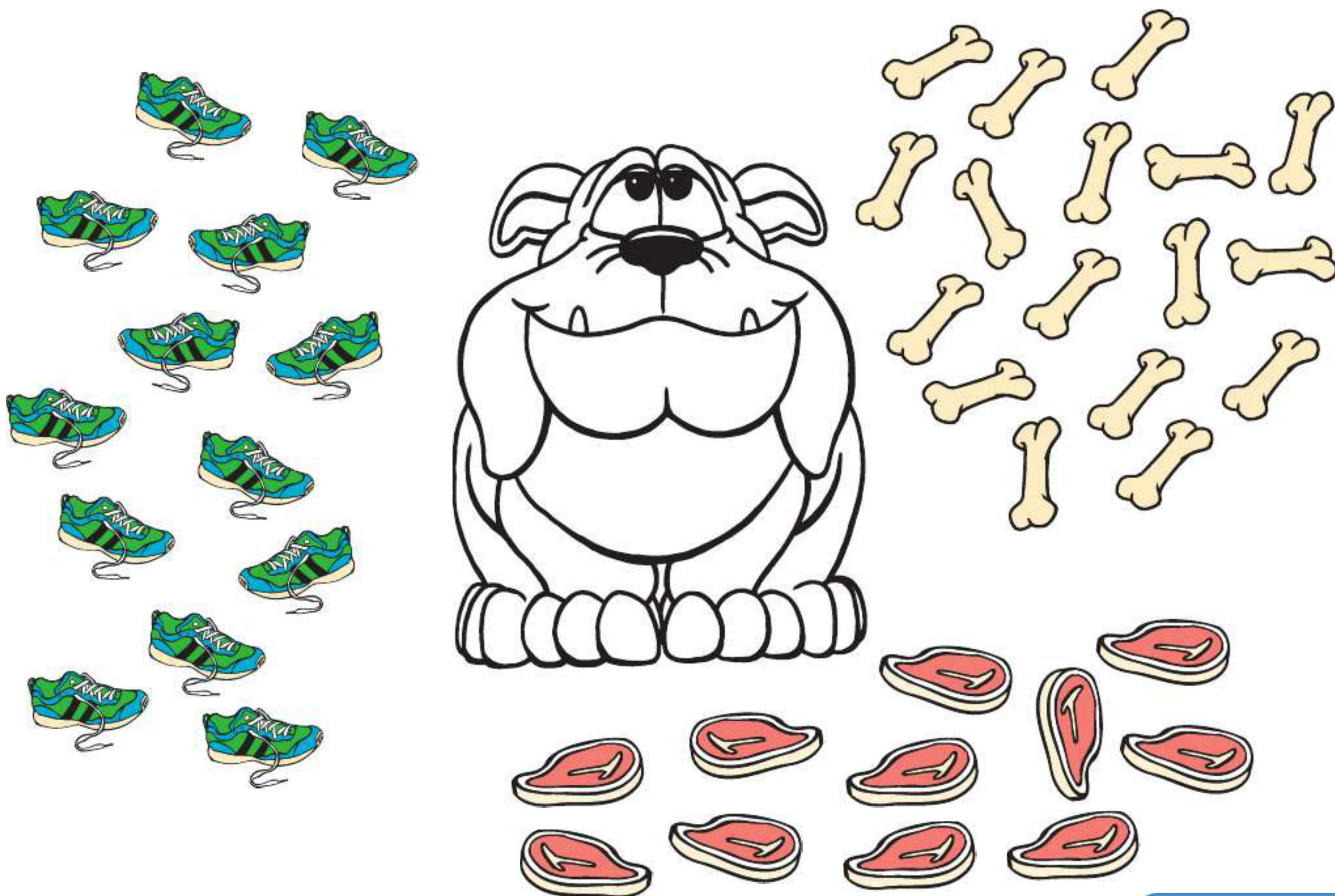
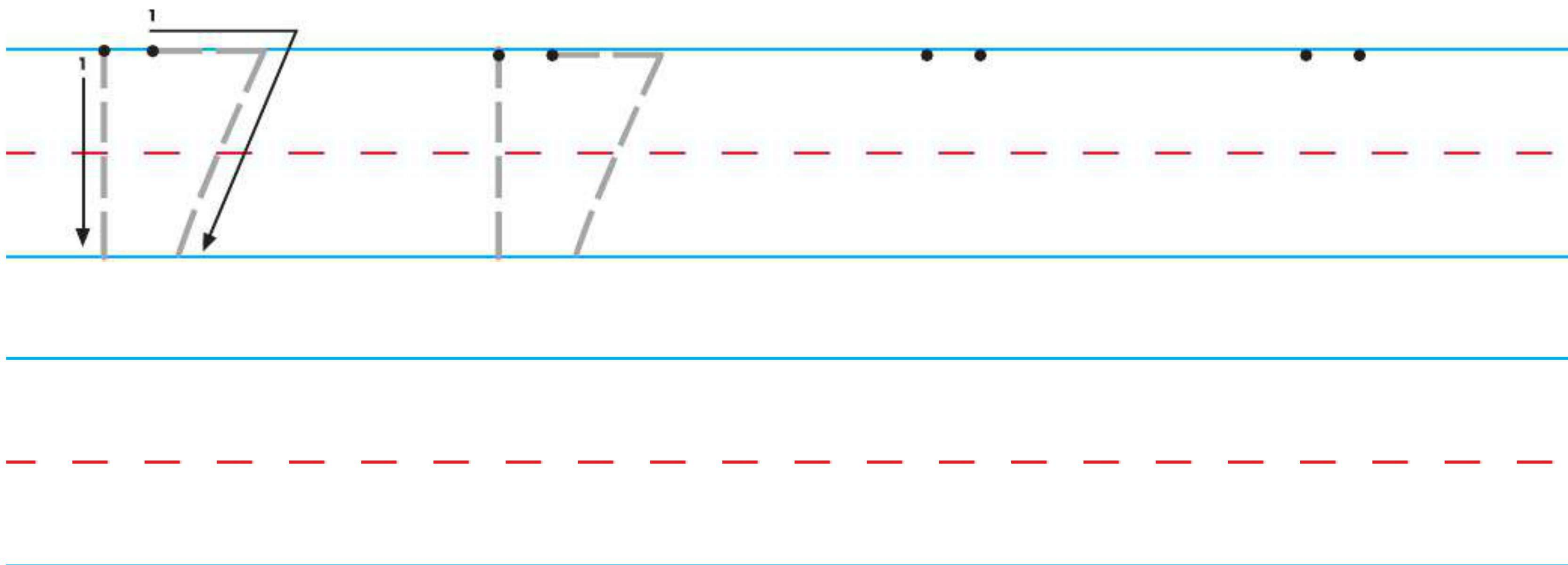



Eighteen 18

Directions: Trace and write the number **18**. Help Filbert Fish find his way to the top. Write the numbers **1** to **18** in each bubble along the way.

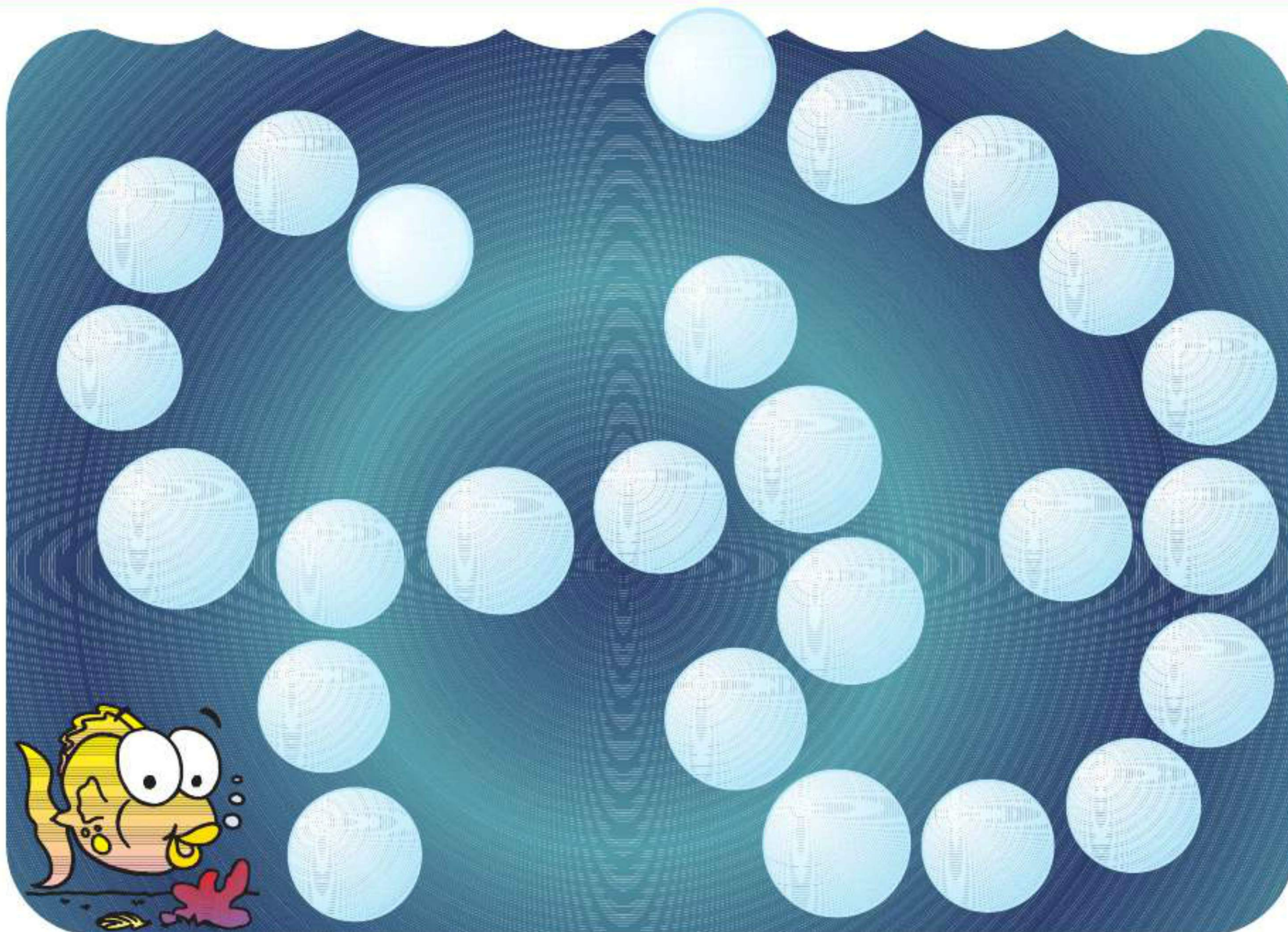
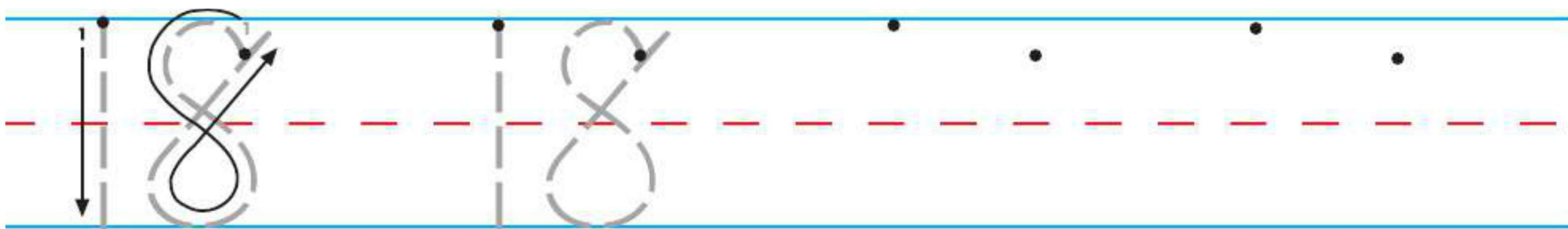



Nineteen 19

Directions: Trace and write the number 19. Circle the numbers 1 through 19 in the picture.

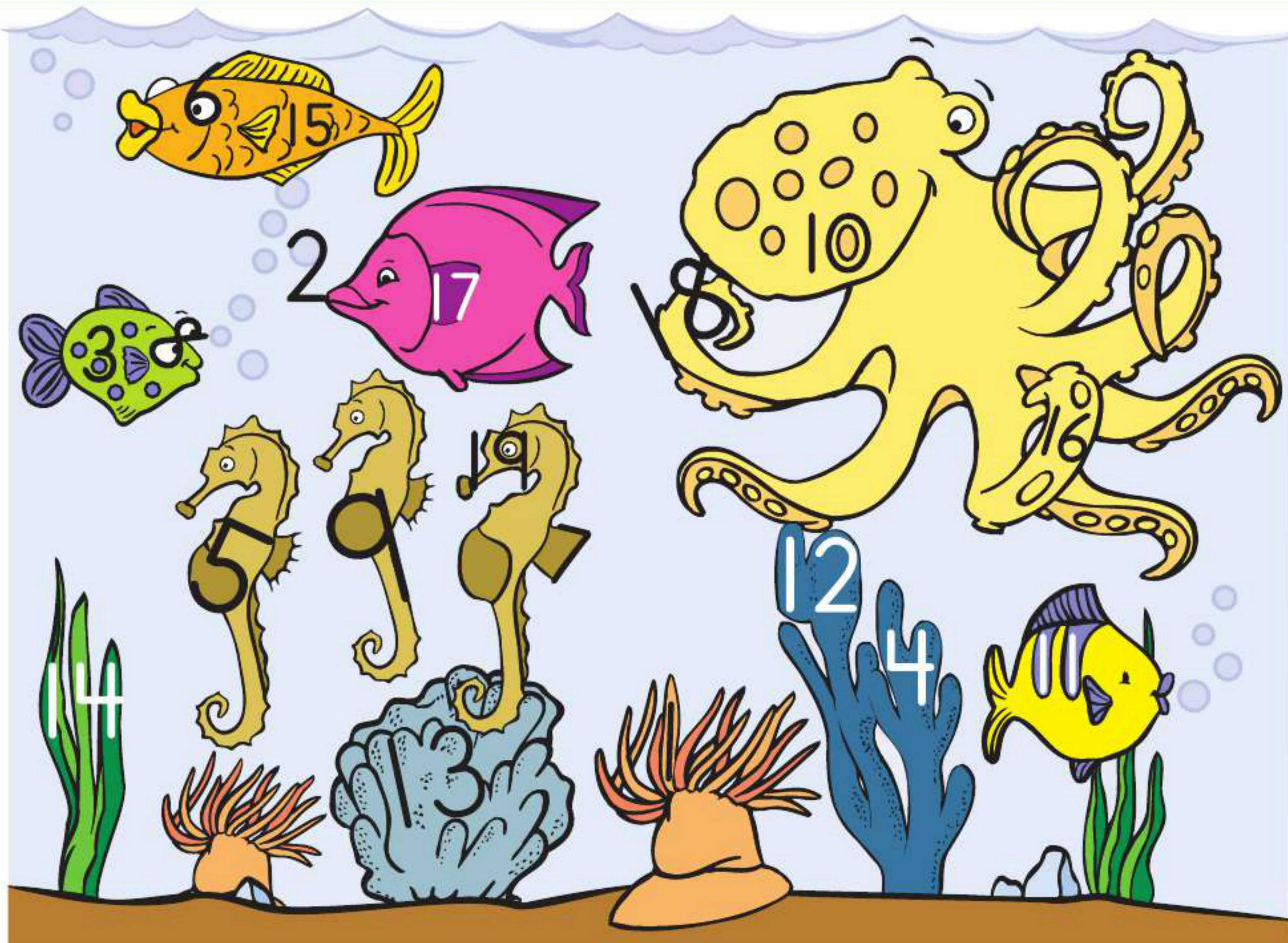
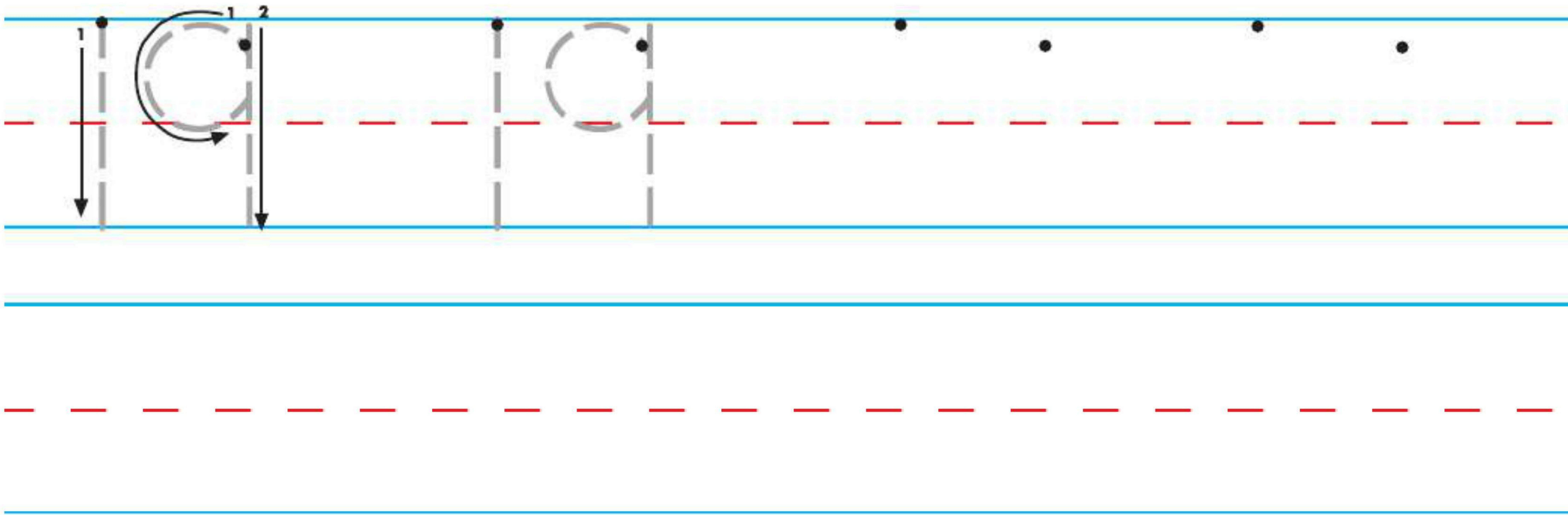



Twenty 20

Directions: Trace and write the number **20**. Connect the dots. Color the picture.

Name _____



Review Numbers 13-20

Directions: Count the number of colored squares. Then, write the correct number.

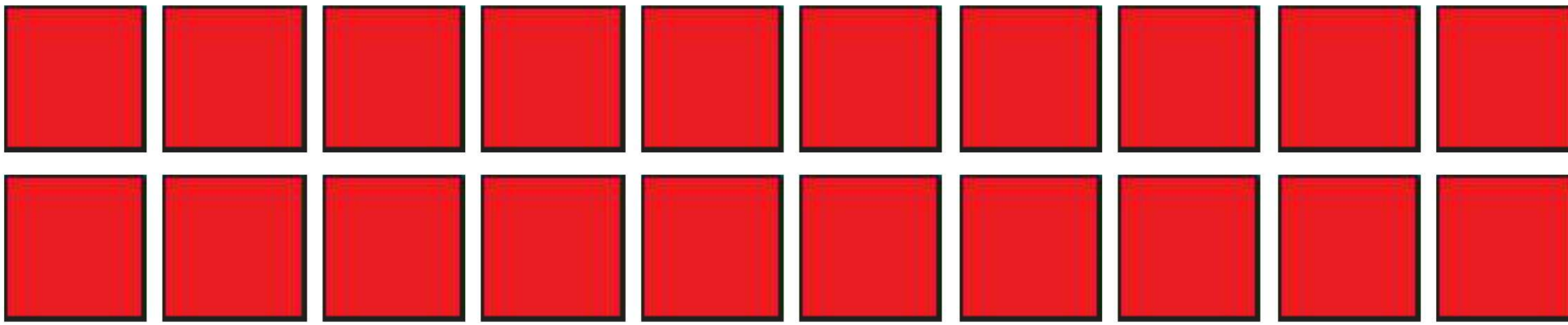

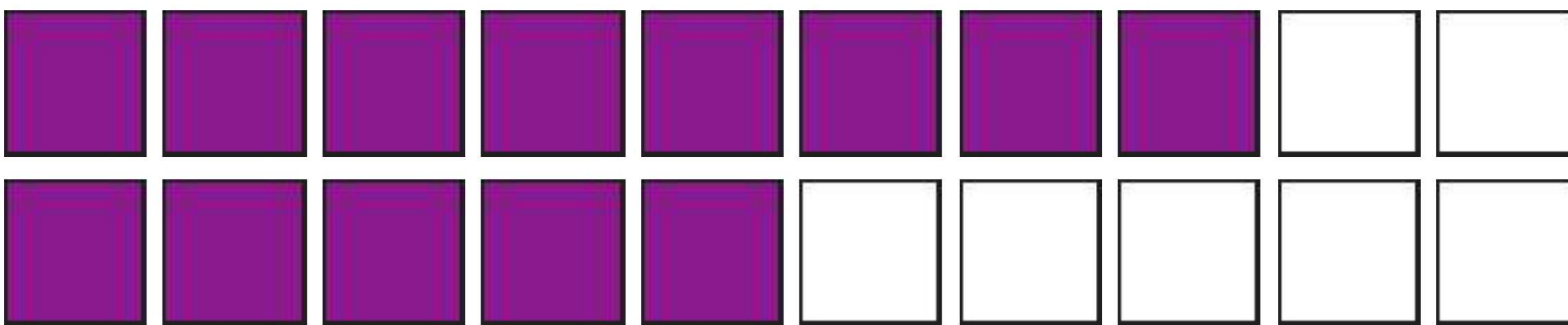

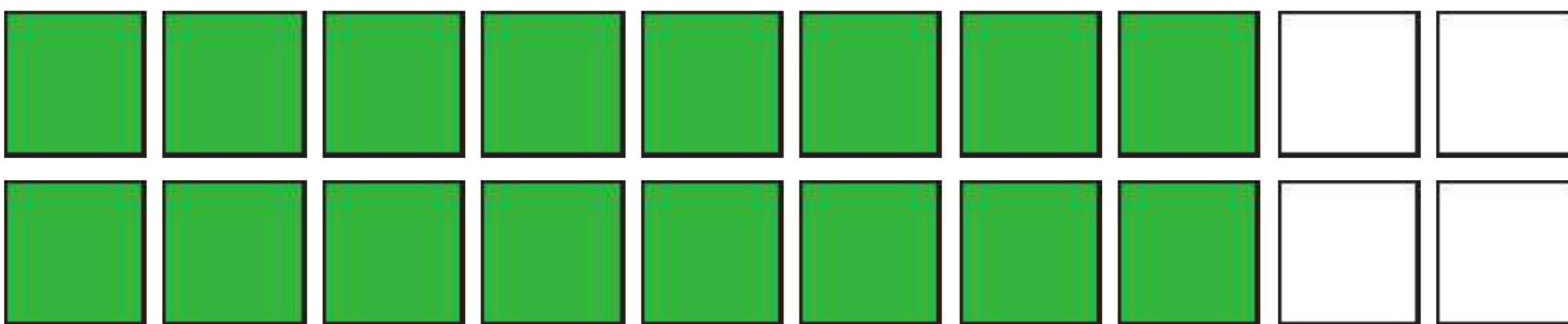

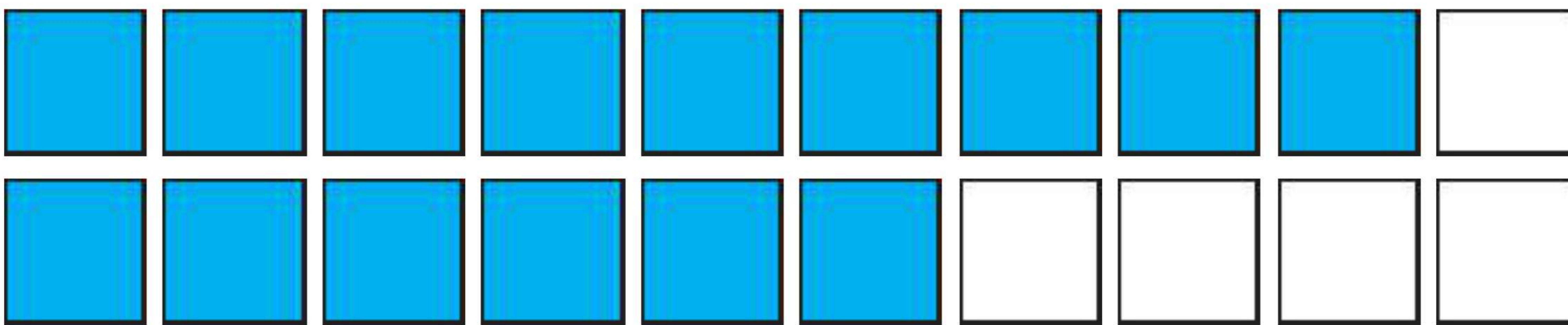

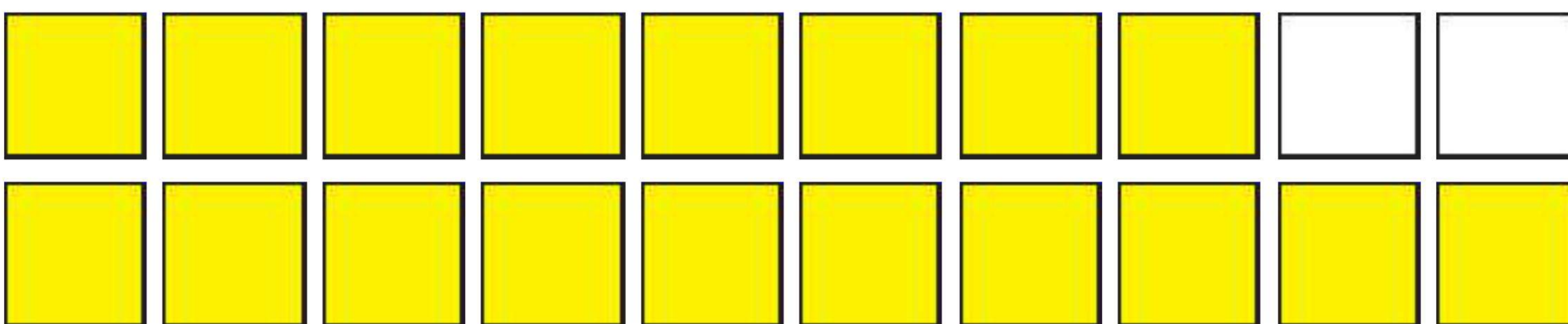



Review Numbers 13-20

Directions: Count the number of colored squares. Then, write the correct number.

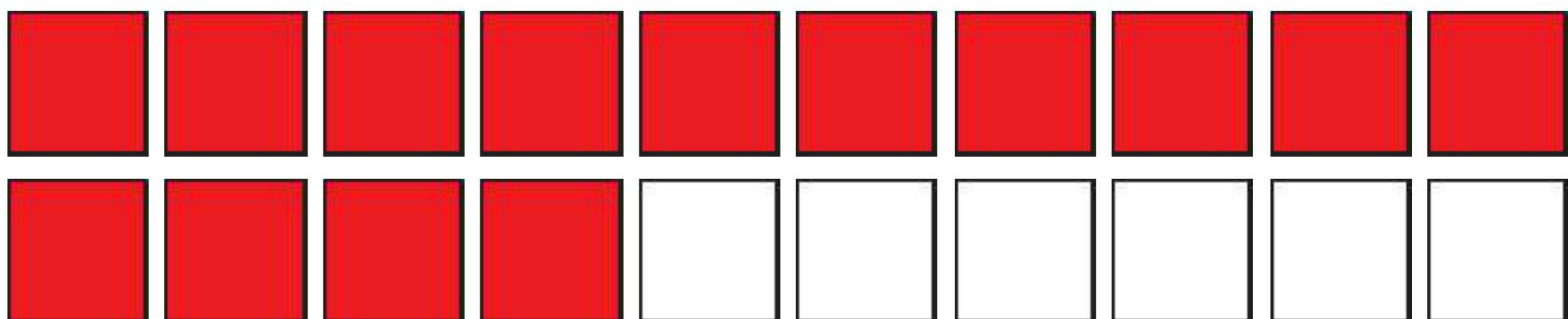

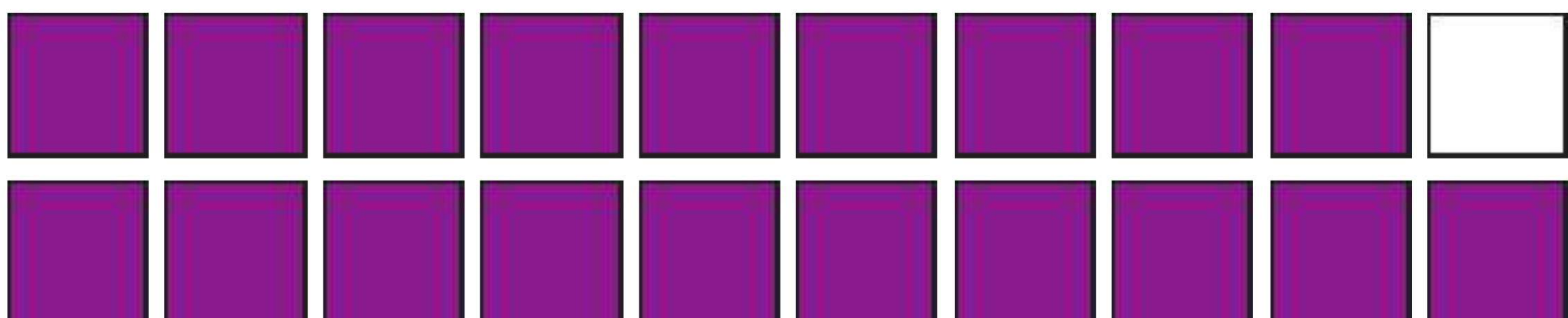

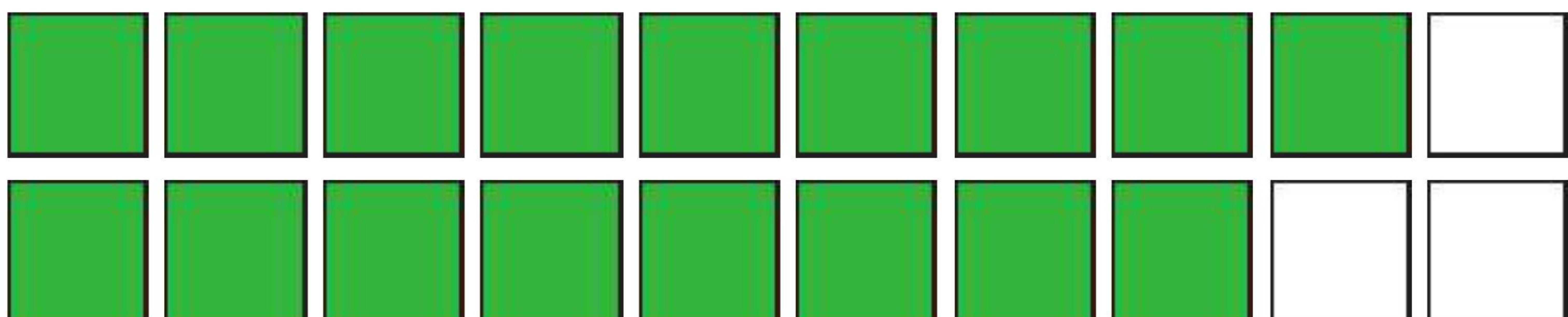

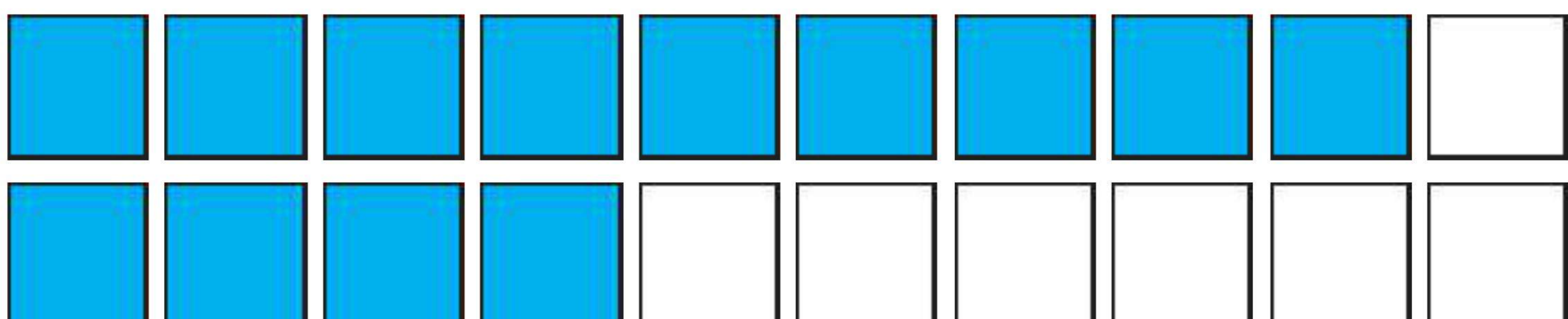

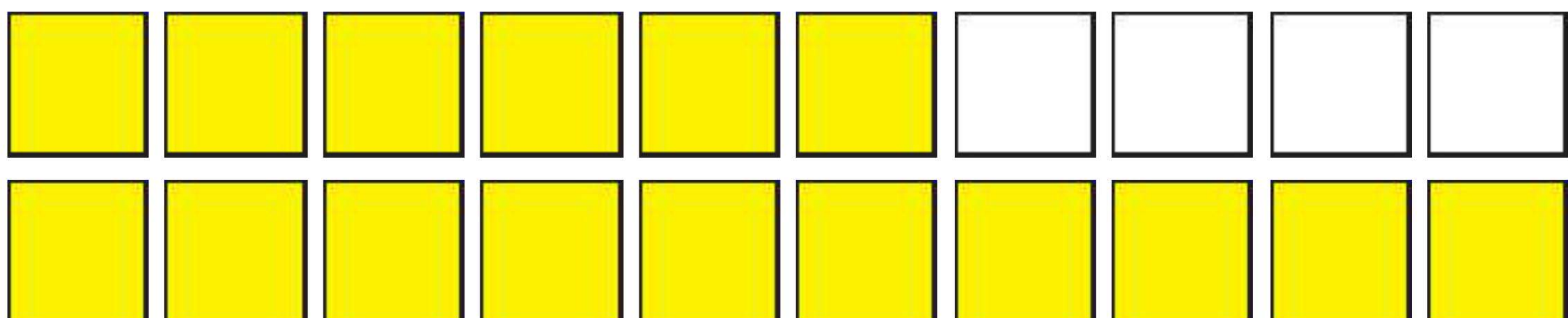



How Much Time?

Directions: Look at the pictures in each row. Circle the picture that takes more time.





Time

Directions: Trace the numbers 1 through 12 in order on the clock.

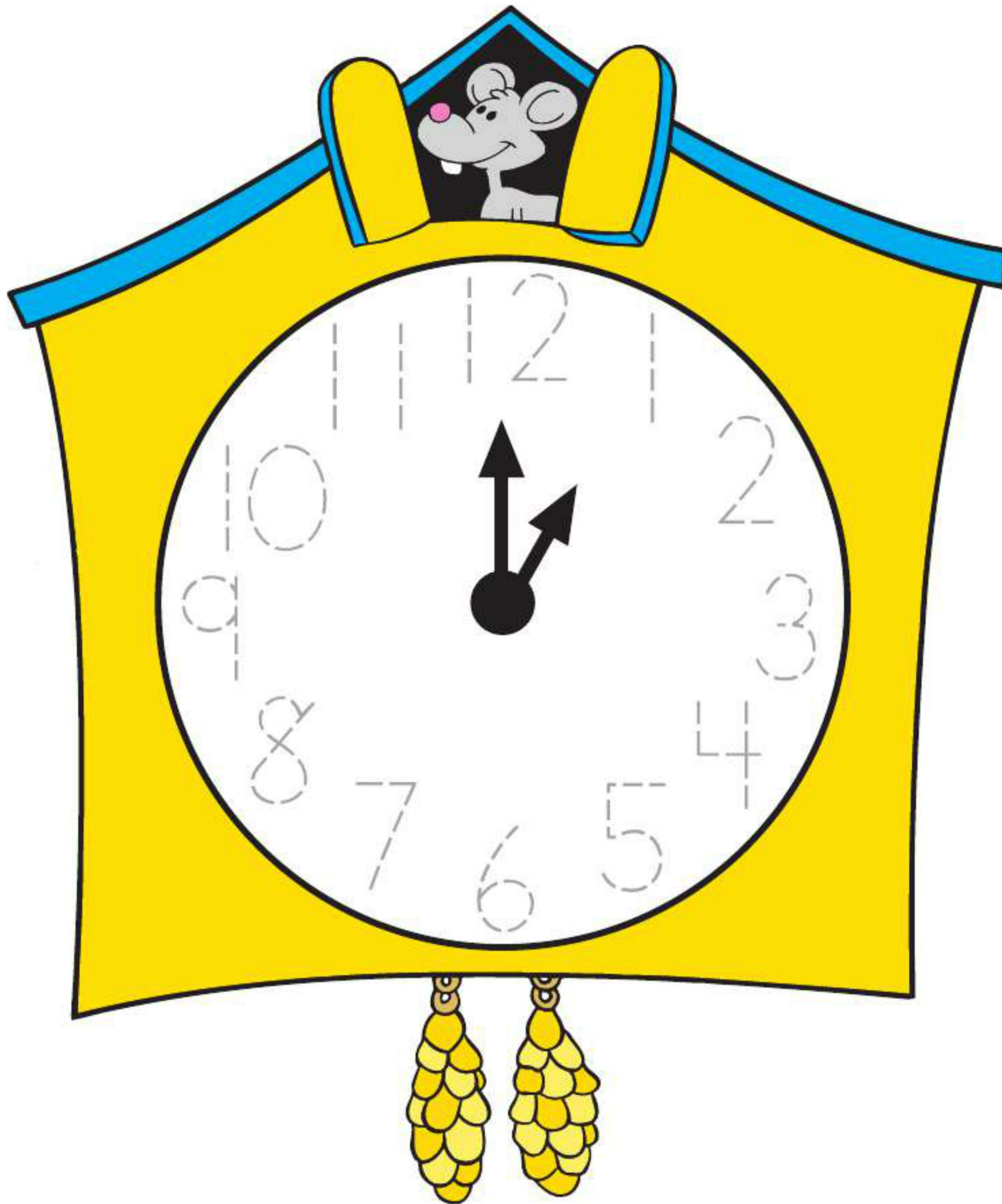

Hickory Dickory Dock,
The mouse ran up the clock.
The clock struck one and down he ran.
Hickory Dickory Dock.

Name _____

TIME



Time

Directions: Write the time that is on each clock.



Example:

2 o'clock



 o'clock



 o'clock

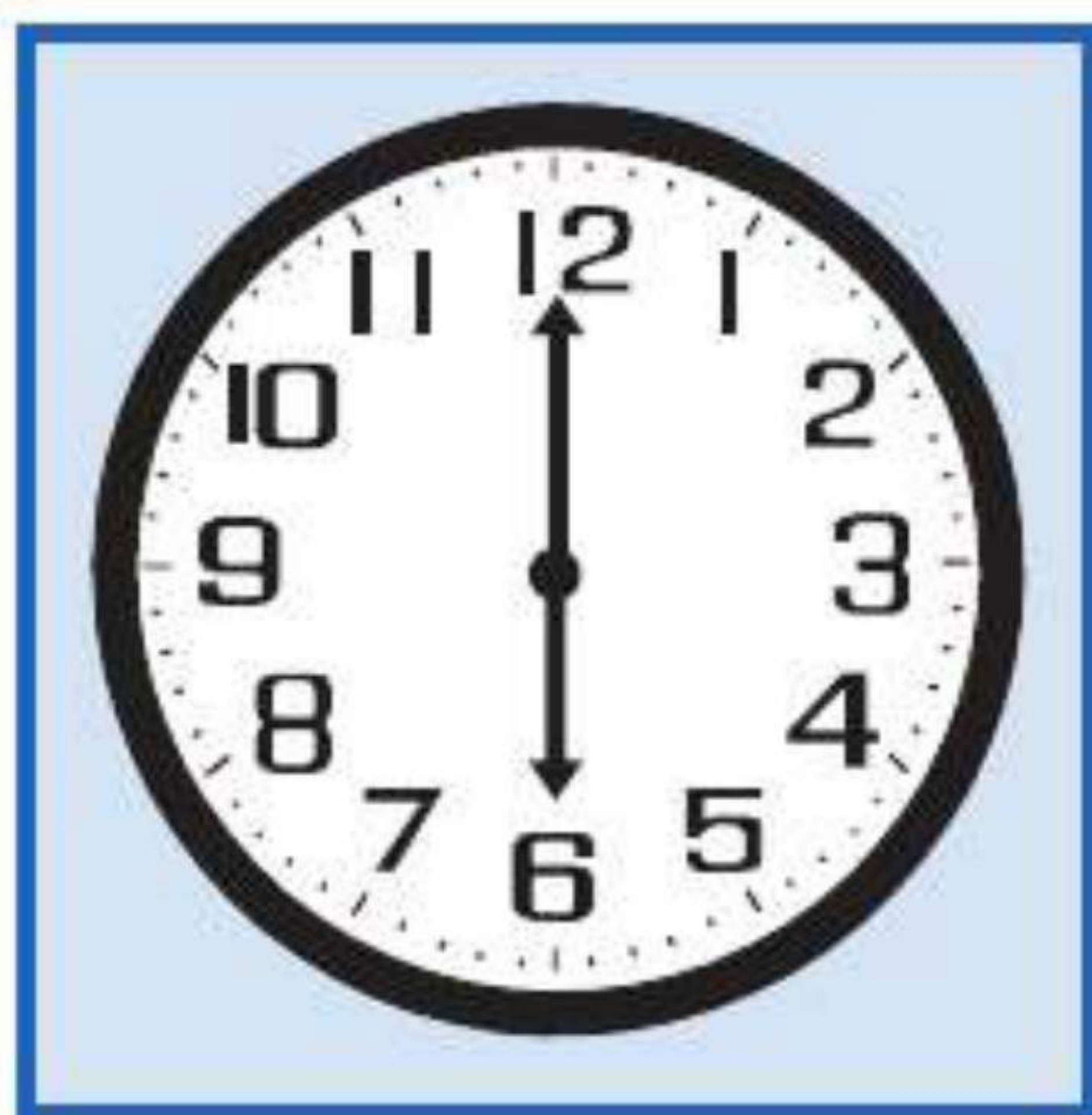

 o'clock



Time

Directions: Write the time that is on each clock.



_____ o'clock



_____ o'clock

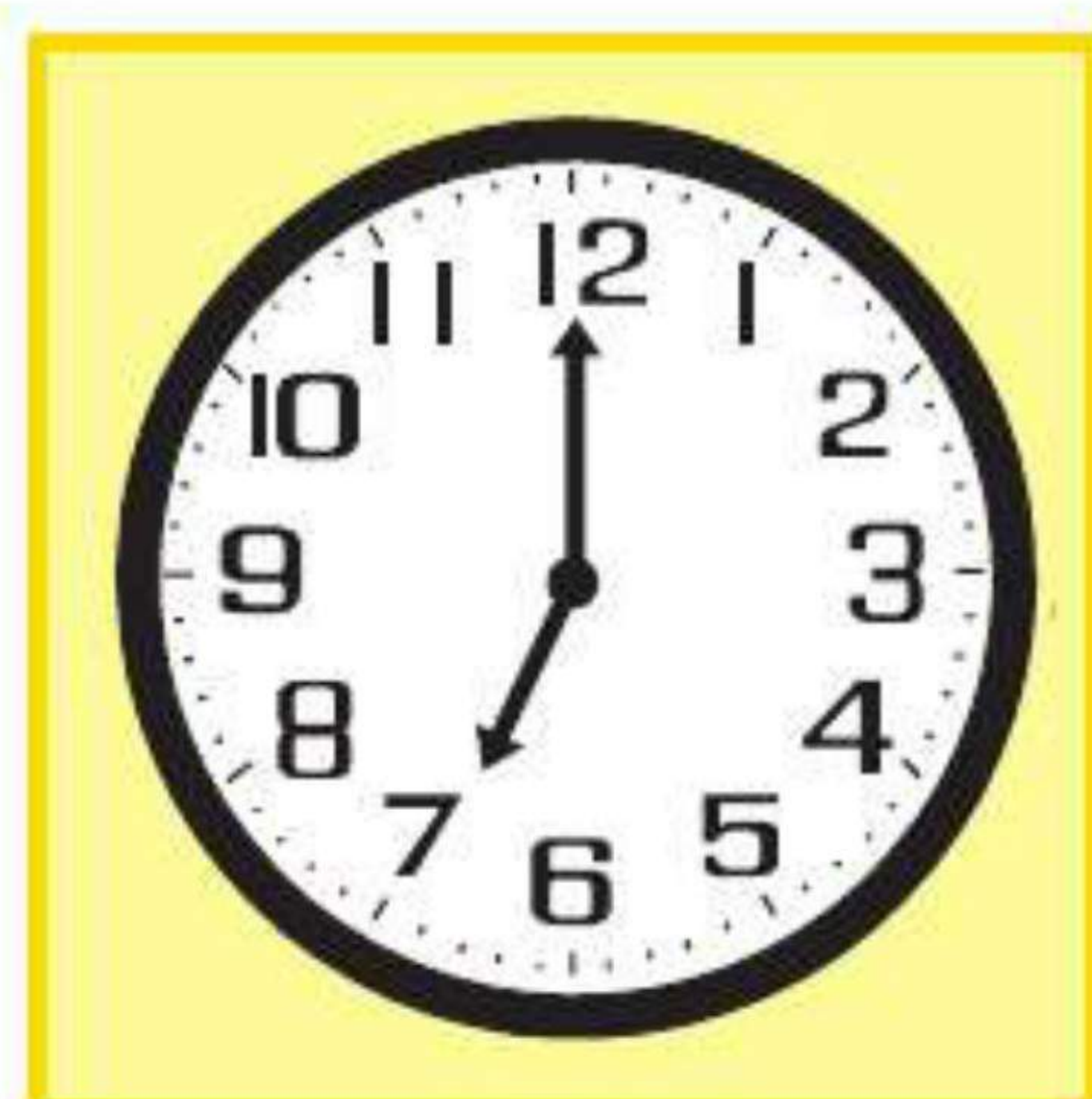

_____ o'clock

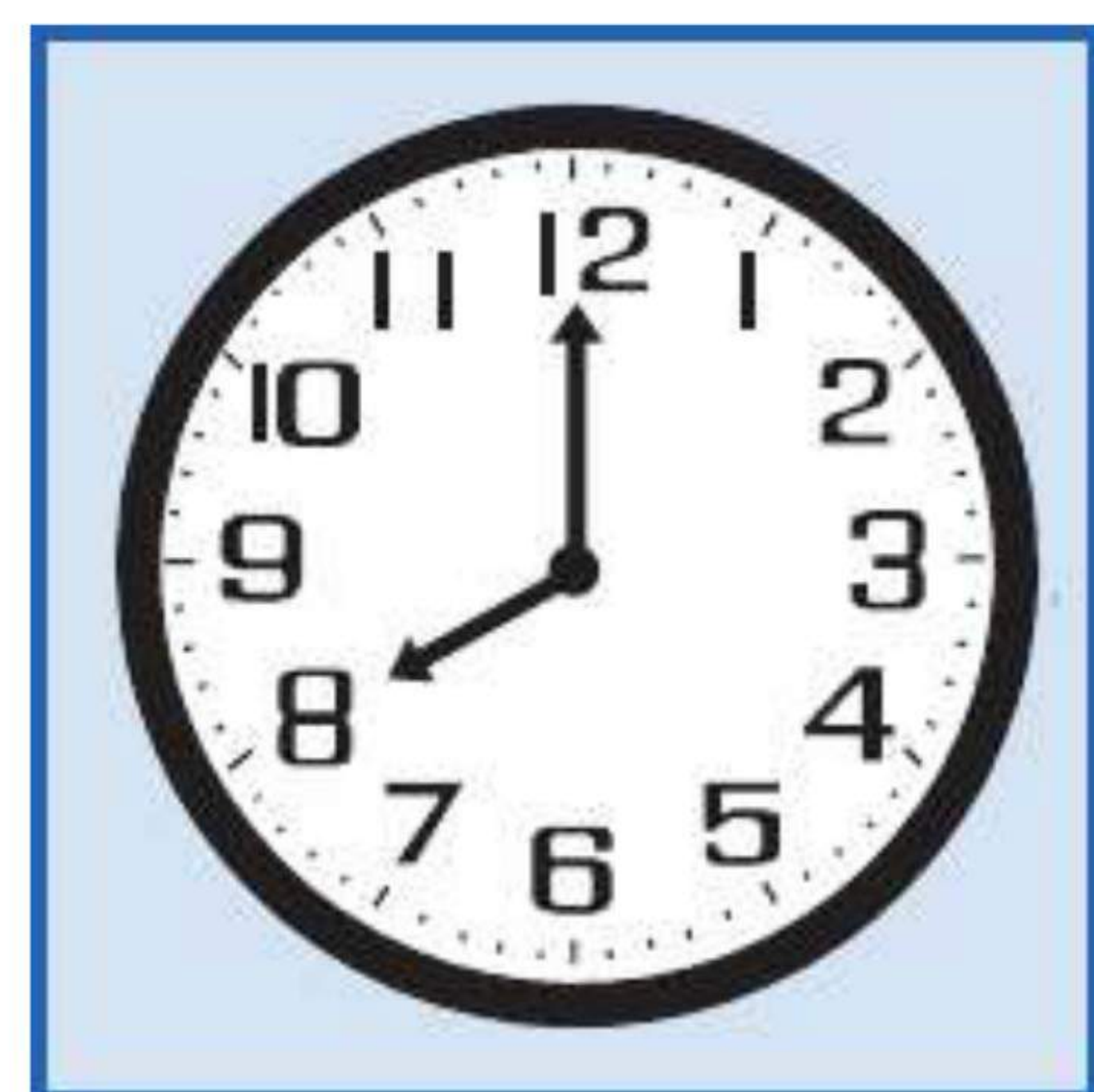

_____ o'clock

Name _____

MONEY



Pennies

Directions: A penny is worth 1¢. It is brown. Circle the correct amount of money in each row below.

Example:



1¢



3¢



1¢

2¢

3¢



5¢

6¢

7¢



7¢

8¢

9¢